



Hillmetal[®]
INSTRUMENTS CO.

“Joining Hands For Healthcare”



Manufacturer and Supplier of Surgical Instruments



www.hillmetalinstruments.com

Surgical
Instruments
Catalogue

Table Of Contents













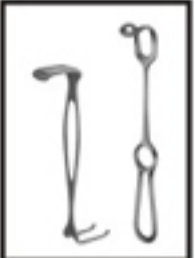

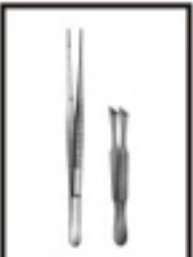
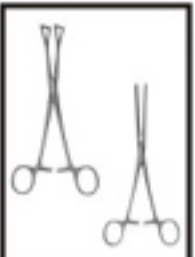
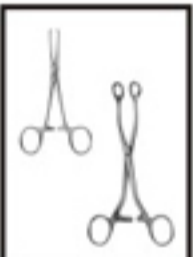
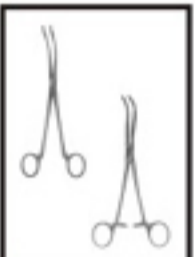
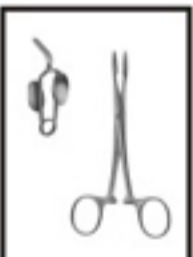
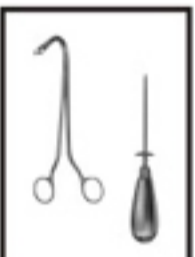
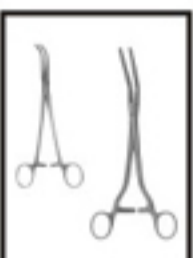
	Page Seite			Page Seite	
Diagnostic, Anaesthesia and other instruments	1 - 10		Probes, Pocket Instruments sets	66 - 68	
Scalpels, knives and Scalpel Handles	11 - 14		Wound Retractors	69 - 80	
Scissors	15 - 31		Self-Retaining Retractors, Abdominal Retractors	81 - 85	
Dissecting-and Tissue Forceps	32 - 42		Abdominal Surgery Intestinal-and Rectal Instruments	86 - 93	
Sponge, Dressing and Tissue Grasping Forceps Towel Clamps	43 - 48		Gall Bladder-, Liver-and Spleen Instruments	94 - 96	
Vessel Clips, Bulldog Clamps Haemostatic Forceps	49 - 57		Genito-Urinary Instruments and Trocars	97 - 100	
Ligature, Hysterectomy and Compression Forceps Vaginal Clamps	58 - 60		Vaginal Specula and Uterine Dilators	101 - 106	
Needle Holders, Suture Instruments	61 - 65		Uterine Probes, Uterine Dressing-, Polypus-and Ovum Forceps	107 - 109	

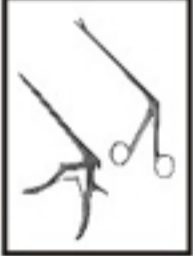

Table Of Contents

	Page Seite		Page Seite	
Biopsy Instruments and Curettes	110 - 116		Suction Instruments	158 - 166
Obstetrics and Tracheotomy	117 - 119			
Cardiovascular-and Thoracic Surgery	120 - 128			
Bone Punches, Rongeurs	129 - 134			
Elevators, Bone Levers, Raspatories, Bone Files, Bone Curettes	135 - 139			
Mallets, Chisels and Gouges	140 - 141			
Bone Holding Forceps, Bone Rongeurs, Bone Cutting Forceps	142 - 146			
Plaster Instruments	147 - 157			



Percussion Hammers and Aesthesiometers



01-101
TROEMNER
Size: 245 mm

½



01-102
DEJERINE
Size: 200 mm

½



01-103
DEJERINE
with needle
Size: 210 mm

½



01-104
TAYLOR
Size: 195 mm

½



01-105
BERLINER
Size: 200 mm

½

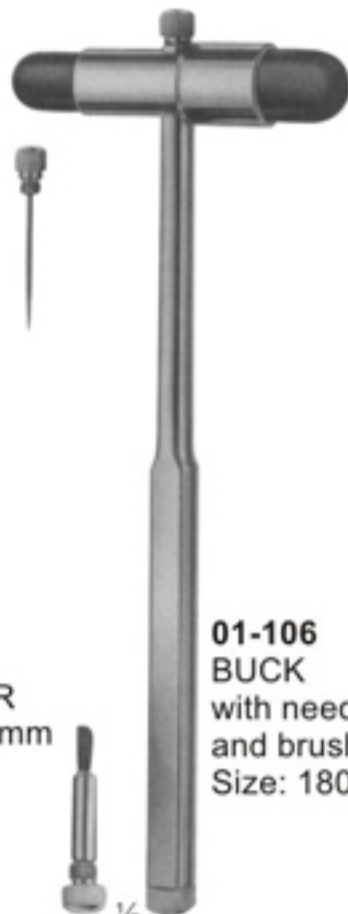

01-106
BUCK
with needle
and brush
Size: 180 mm

½



01-107
RABINER
with needle
and brush
Size: 255 mm

½



01-108
ALY
Size: 190 mm

½



01-109
WARTENBERG
Pinwheel for
neurological
examination
Size: 185 mm

½

Stethoscopes



01-110
PINARD (Aluminum)
Size: 155 mm

½



01-111
wooden
Size: 145 mm

½



01-112
BOWLES
Stethoscope
with diaphragm

¼



01-113
ANESTOPHON

⅓



01-114
FORD-BOWLES
Dual chest piece
with two outlets

¼



01-115
BOWLES

¼

Head Mirrors and Head Bands

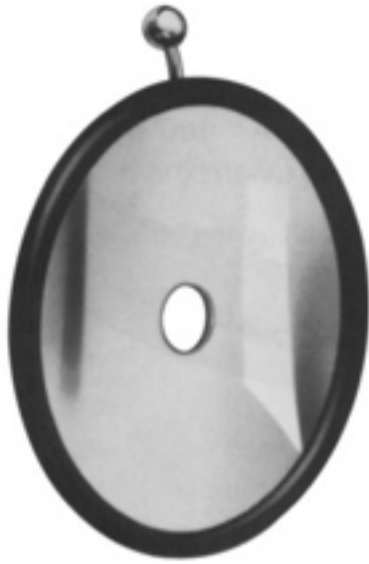

01-116
ZIEGLER Ø 90mm
head mirror only
with rubber coating

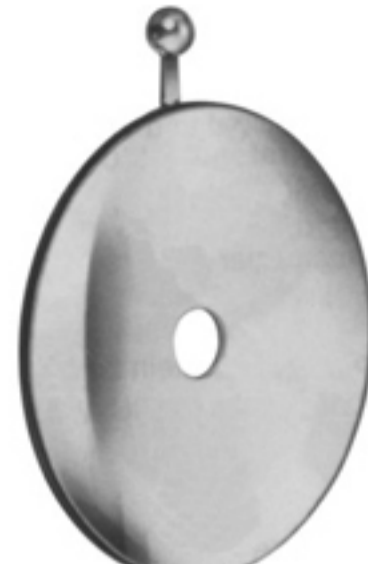

01-117
ZIEGLER Ø 90mm
head mirror only
with metal coating



01-118
ZIEGLER
head band of plastic black

01-119
ZIEGLER
head band of plastic white

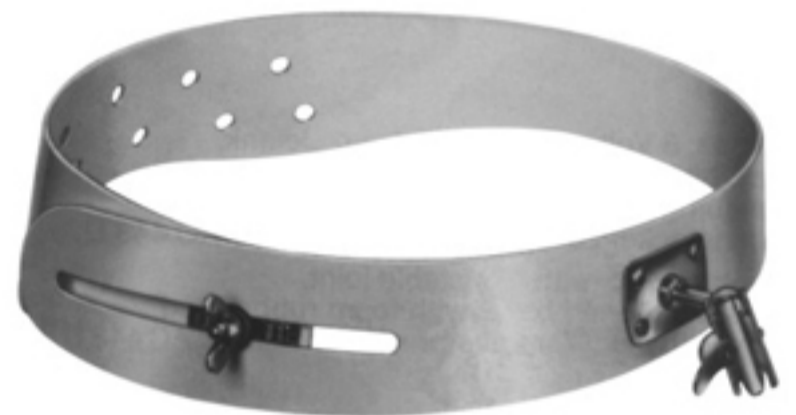

01-120
MURPHY
head band of celluloid, white

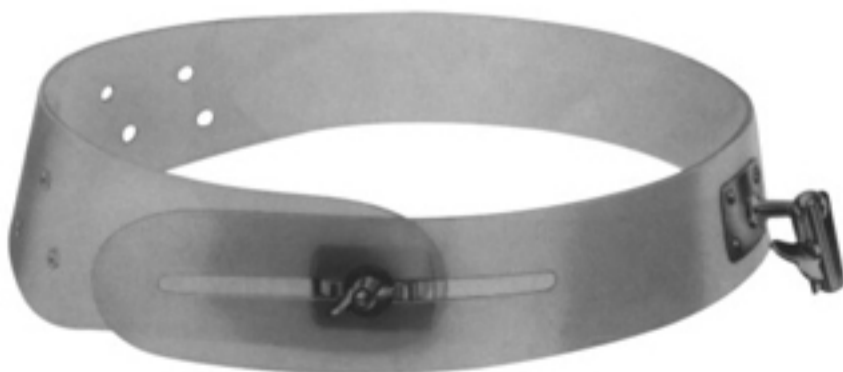

01-121
head band of plastic,
white, soft pattern



01-122
head mirror with black
plastic head band.

Instruments for Anaesthesia and Tongue Forceps



½

01-134
SCHIMMELBUSCH
 Ether mask



½

01-135
HEISTER
 Mouth gag
 Size: 130 mm



½

01-136
FERGUSON-ACKLAND
 Mouth gag
 Size: 145 mm



½

01-137
DENHARDT
 Mouth gag with silicon
 inserts, interchangeable
 Size: 125 mm



½

01-138
ROSER KOENIG
 Mouth gag
 Size: 160 mm, 185 mm

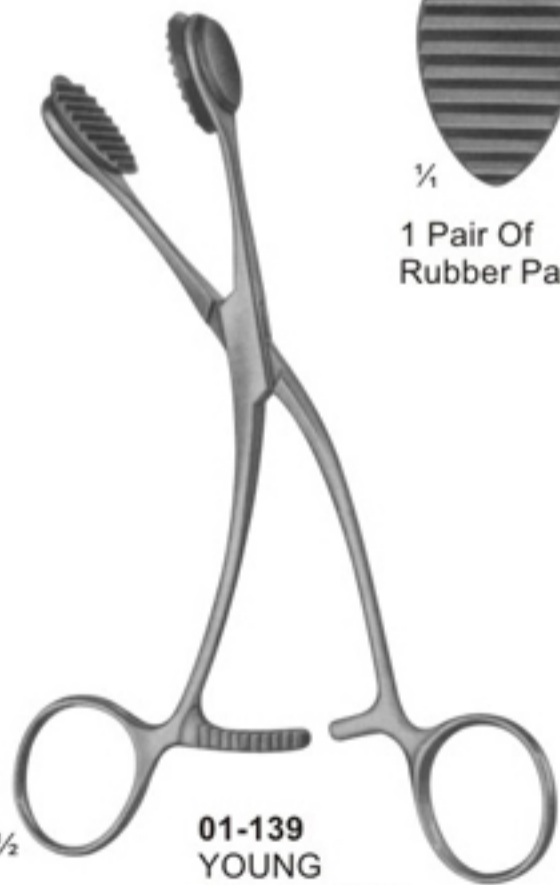

½

01-139
YOUNG
 Size: 165 mm



¼

1 Pair Of
 Rubber Pads

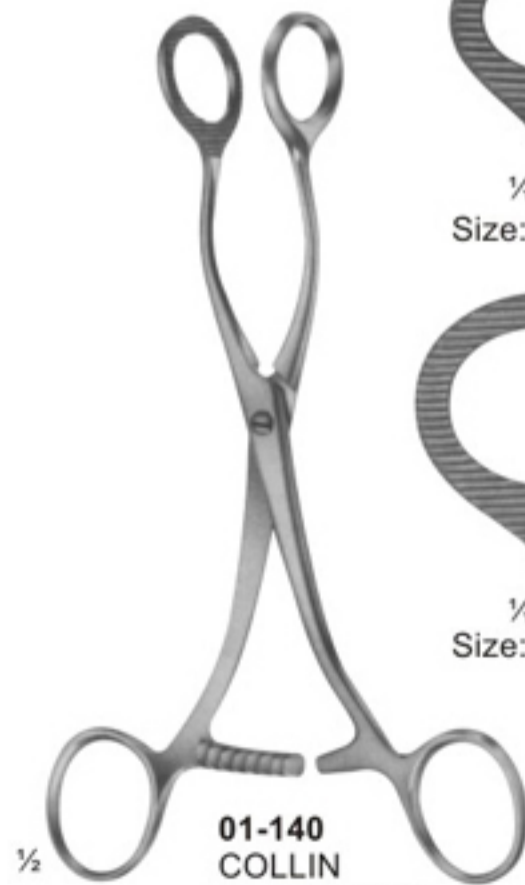

½

01-140
COLLIN
 Size: 160 mm,
 170 mm



¼

Size: 160 mm



¼

Size: 170 mm

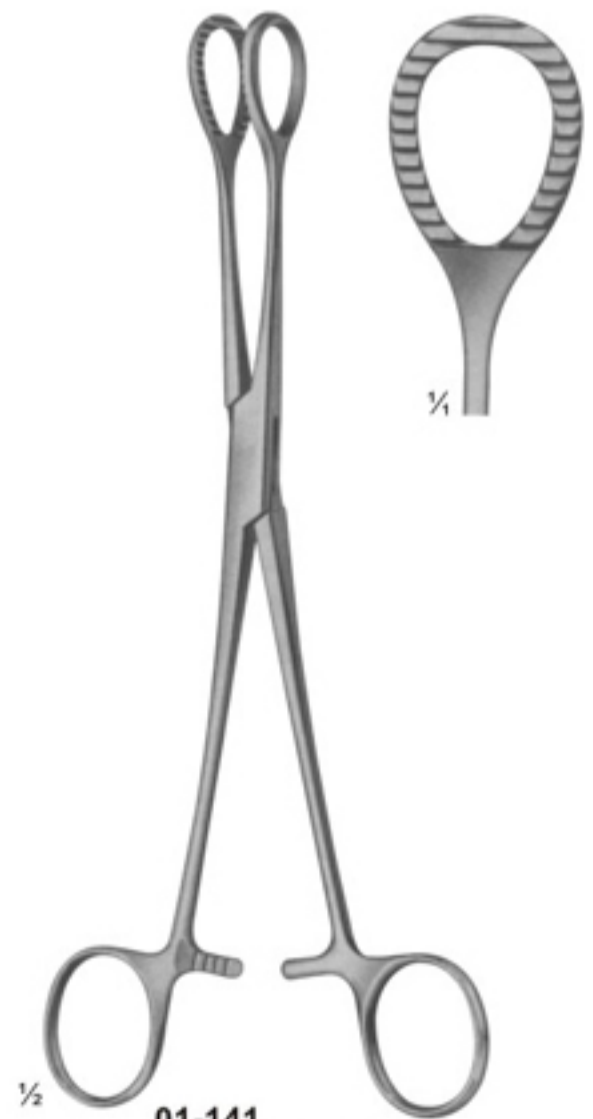

½

01-141
HEYWOOD-SMITH
 modif. Size: 215 mm

Blood Lancets and Laryngeal Mirrors



01-142
FRANCKE
 Automatic blood lancet



01-143
 Laryngeal mirrors with
 hexagonal handle
 Size: 180 mm

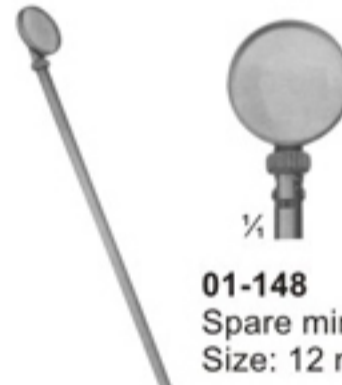
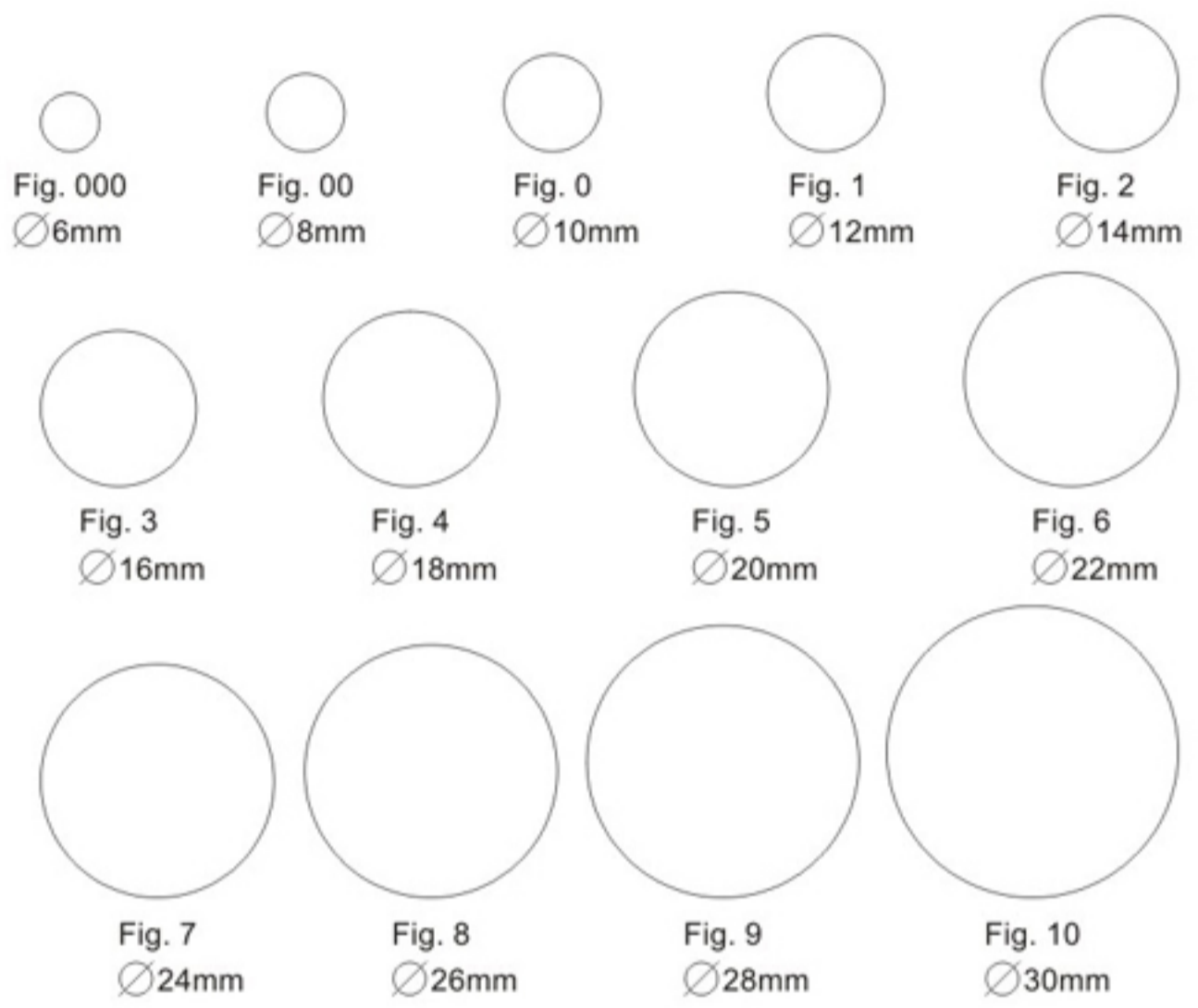

01-148
 Spare mirrors only
 Size: 12 mm



01-149
 Spare mirrors only
 Size: 14 mm



01-144
KOLLE
 Microscopic Needle
 Holder with plastic
 handle.
 Size: 240 mm



01-145
 Mirror handle
 Size: 110 mm



01-146
 Mirror handle
 Size: 105 mm



01-147
MICHEL
 Rhinoscopic mirrors with
 interchangeable mirror inserts
 Size: 250 mm

Laryngoscope and Diagnostic Sets



01-150
Infants
Size: 150 mm



01-151
Children
Size: 200 mm



01-152
Adults
Size: 250 mm



01-154



01-150 - 152
MAGILL



01-153
Medium battery handle
only, 25 mm diam.



01-153-A
Spare bulb
2.7 volt, for
otoscopes



01-153-B
Spare bulb
2.6 volt, for
ophthalmoscopes



01-155



01-156
Otoscope set, consists of
battery handle without batteries,
3 ear specula, 1 bulb in velvet lined case



01-157
Diagnostic set, otoscope with three specula,
nasal speculum, lamp holder, two laryngeal
mirrors, tongue blade holder

Laryngoscopes



1/3

**01-158
MILLER**
Laryngoscope set, consists of battery handle (without battery)
with four miller laryngoscope blades

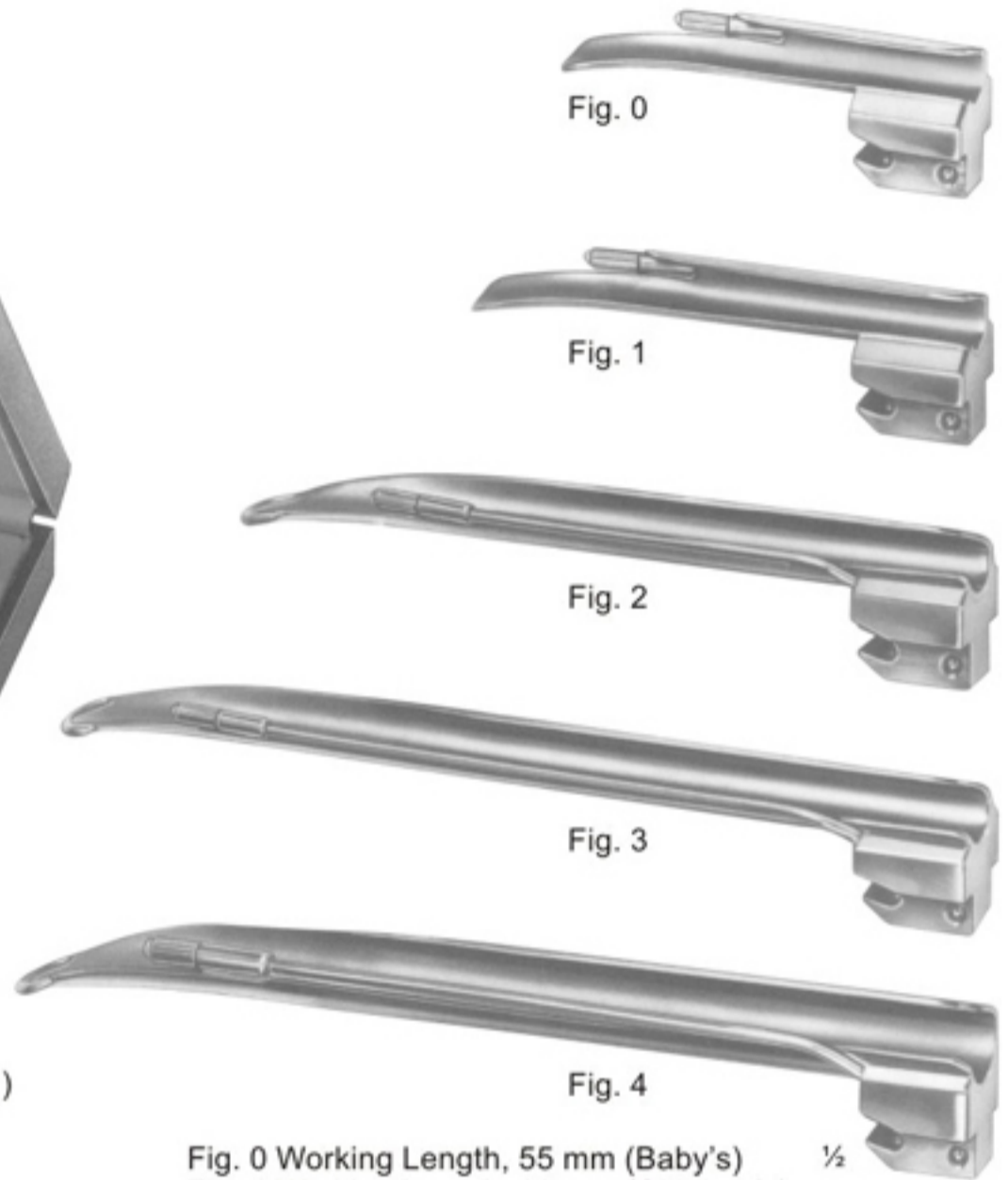

Fig. 0

Fig. 1

Fig. 2

Fig. 3

Fig. 4

Fig. 0 Working Length, 55 mm (Baby's) 1/2
 Fig. 1 Working Length, 80 mm (Children's)
 Fig. 2 Working Length, 130 mm (Adolescent's)
 Fig. 3 Working Length, 170 mm (Women's)
 Fig. 4 Working Length, 180 mm (Men's)



1/3

**01-159
GUEDEL-NEGUS**
Laryngoscope set, consists of battery handle (without battery)
with four miller laryngoscope blades

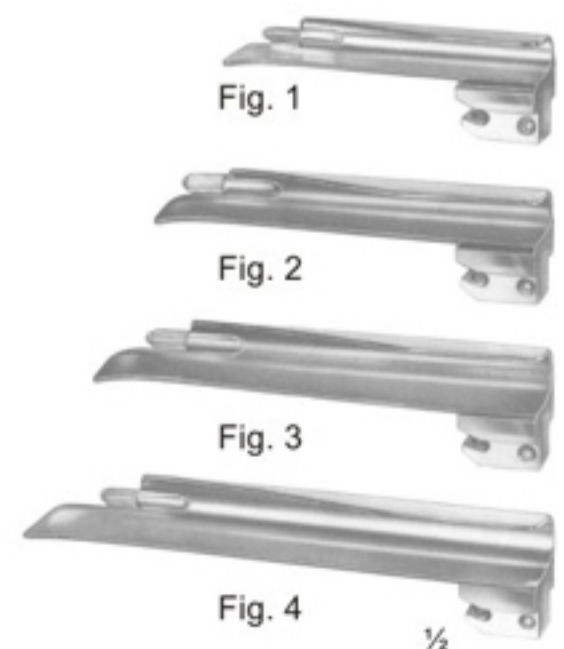

Fig. 1

Fig. 2

Fig. 3

Fig. 4

Fig. 1 Working Length, 70 mm (Children's) 1/2
 Fig. 2 Working Length, 90 mm (Adolescent's)
 Fig. 3 Working Length, 110 mm (Women's)
 Fig. 4 Working Length, 135 mm (Men's)

Laryngoscopes



1/3

01-160
 McINTOSH
 Laryngoscope Set, Consists Of Battery Handle (Without Battery)
 With Three McIntosh Blades, Fig. 1, Fig. 2, Fig. 3

01-161
 McINTOSH
 Laryngoscope Set, Consists Of Battery Handle (Without Battery)
 With Five McIntosh Blades, Fig. 0, Fig. 1, Fig. 2, Fig. 3, Fig. 4

Fig. 0

Fig. 1

Fig. 2

Fig. 3

Fig. 4

1/2

01-161 A Fig. 0 Working Length, 55 mm (Baby's)
 01-161 B Fig. 1 Working Length, 75 mm (Children's)
 01-161 C Fig. 2 Working Length, 90 mm (Adolescent's)
 01-161 D Fig. 3 Working Length, 110 mm (Women's)
 01-161 E Fig. 4 Working Length, 135 mm (Men's)



1/3

01-162
 FOREGGER
 Laryngoscope Set, Consists Of Battery Handle (Without Battery)
 With Three Foregger Blades, Fig. 1, Fig. 2, Fig. 3,

01-163
 FOREGGER
 Laryngoscope Set, Consists Of Battery Handle (Without Battery)
 With Four Foregger Blades, Fig. 1, Fig. 2, Fig. 3, Fig. 4,

Fig. 1

Fig. 2

Fig. 3

Fig. 4

1/2

01-162 A Fig. 1 Working Length, 70 mm (Children's)
 01-162 B Fig. 2 Working Length, 90 mm (Adolescent's)
 01-162 C Fig. 3 Working Length, 110 mm (Women's)
 01-162 D Fig. 4 Working Length, 135 mm (Men's)



1/3

01-164
 Fiber Optic
 Battery Handle
 30mm diam.



1/3

01-165
 Fiber Optic
 Battery Handle
 18mm diam.



1/3

01-166
 Replacement Lamp
 (Krypton) 2.5 V



1/3

01-167
 Replacement Lamp
 (Halogen) 2.5 V

Examination & Measuring Instruments

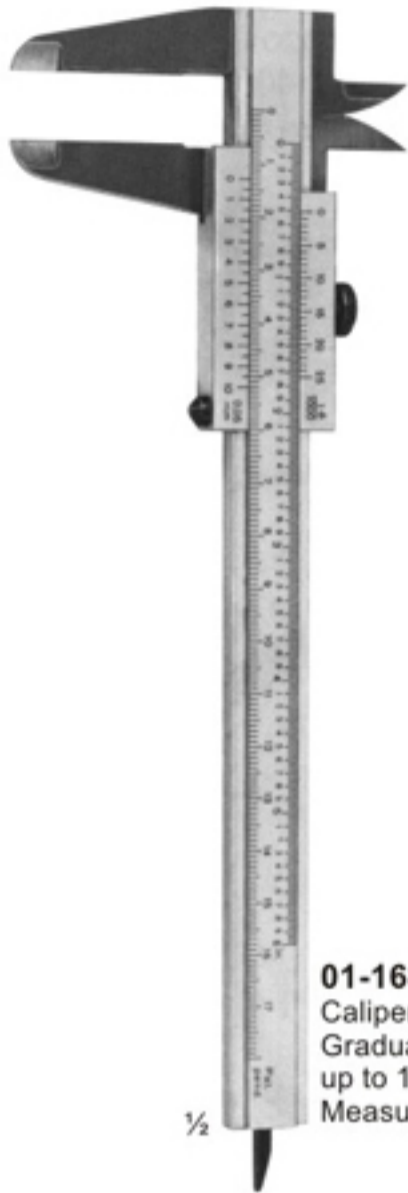

01-168
 Caliper Of Aluminium
 Graduated in mm & inches
 up to 180mm
 Measuring Range up to 139mm

1/2



01-169
 VERNIER
 Universal Caliper Of Steel
 Graduated in mm & inches
 up to 180mm
 Measuring Range up to 120mm
 with Vernier in 1/10mm & 1/16"

1/2



1/2

01-170
 CARROLL
 Size: 145 mm
 Finger Goniometer



1/2

01-171
 TOWNLEY
 Graduated in
 mm & inches
 Size: 115 mm



1/2

01-172
 COLLIN
 Druck Pressure 72 kg
 Size: 125 mm



1/2

01-173
 BERTILLON
 Caliper For Measuring The Head
 Size: 320 mm



1/4

01-174
 CASTROVIEJO
 Caliper
 Size: 75mm



1/2

01-175
 MOLTGEN
 Goniometer



01-176
 Size: 150 mm



01-177
 Size: 500 mm

Dissecting Knives



½
02-101 - 110
Fig. 1 - 10



¼
02-101
Fig. 1
30 mm



02-102
Fig. 2
36 mm



02-103
Fig. 3
40 mm



02-104
Fig. 4
45 mm



02-105
Fig. 5
50 mm



¼
02-106
Fig. 6
27 mm



02-107
Fig. 7
35 mm



02-108
Fig. 8
40 mm



02-109
Fig. 9
47 mm



02-110
Fig. 10
50 mm

Amputating Knives, Cartilage Knives and Autopsy Knives



LISTON
02-111
 Size: 130 mm
02-112
 Size: 160 mm
02-113
 Size: 190 mm
02-114
 Size: 200 mm

02-115
 CATLIN
 Size: 160 mm
 Blade length
 Amputating
 Knives

02-116
 LANGENBECK
 Size: 120 mm
 Blade length
 Flap Knives

02-117
 Size: 110 mm
 Blade length
 Interosseous
 Knives

02-118
 Size: 55 mm
 Blade length
 with raspatory,
 Wooden handle

02-119
 Size: 70 mm
 Blade length
 Wooden handle

02-120
 Size: 80 mm
 Blade length
 Metal handle

02-121
 Size: 195 mm
 Blade length
 Metal handle

Blade length
 Amputating Knives

Cone Knives, Myomatome, Trigeminal and Tonsil Knives



02-122
 AYRE
 Size: 235 mm
 Cone Knife

02-123
 Size: 230 mm
 Cone Knife

02-124
 SEGOND
 Size: 270 mm
 Myomatome

02-125
 OLIVECRONA
 Size: 205 mm
 Trigeminal
 Knife

02-126
 Size: 230 mm
 Trigeminal
 Knife

02-127
 FOWLER
 Size: 200 mm
 Tonsil Knife

02-128
 ABRAHAM
 Size: 215 mm
 Tonsil Knife

02-129
 BRUNINGS
 Size: 215 mm
 Tonsil Knife

Scalpel Handles



1/4	1/4	1/4	1/4	1/4	1/4	1/4	1/4	1/4	1/4
02-130 STANDARD No. 3 Solid 12 cm	02-131 No. 3 Solid 12 cm	02-132 No. 3 Solid 12 cm	02-133 No. 3 L Straight Solid 21.5 cm	02-134 No. 3 L Angled Solid 21 cm	02-135 No. 7 Solid 16 cm	02-136 No. 7 K Solid 12.5 cm	02-137 Hollow-Round 15.5 cm	02-138 No. 3 Straight Solid, Round 14.5 cm	02-139 No. 3 Angled Solid, Round 14 cm

Micro Scissors (Spring Type) with Flat Handles

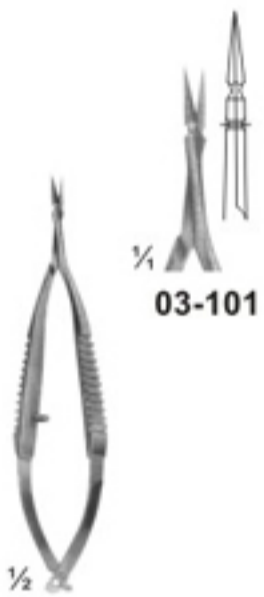

03-101 - 103
VANNAS
Size: 85 mm



03-104 - 105
CASTROVIEJO
Size: 95 mm

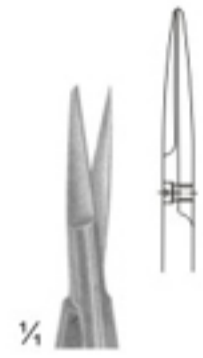

03-106
NOYES
Size: 125 mm

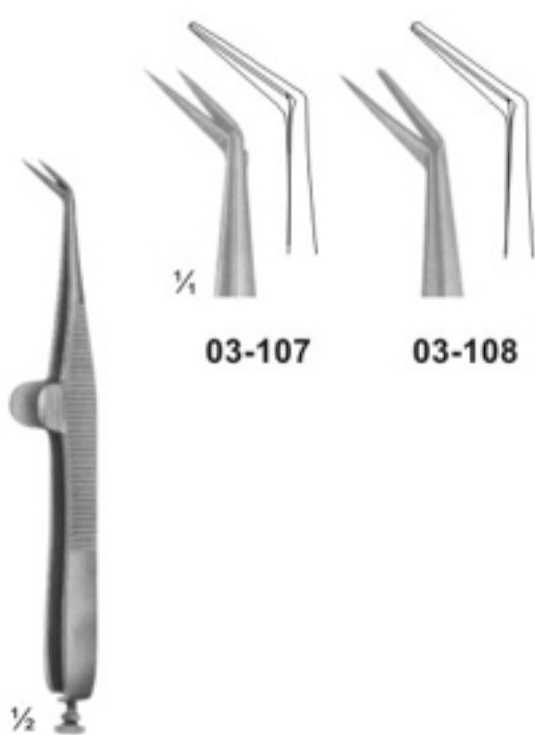

03-107 - 108
WECKER
Eye scissor
Size: 110 mm



03-109
CASTROVIEJO
Eye scissor
Size: 115 mm

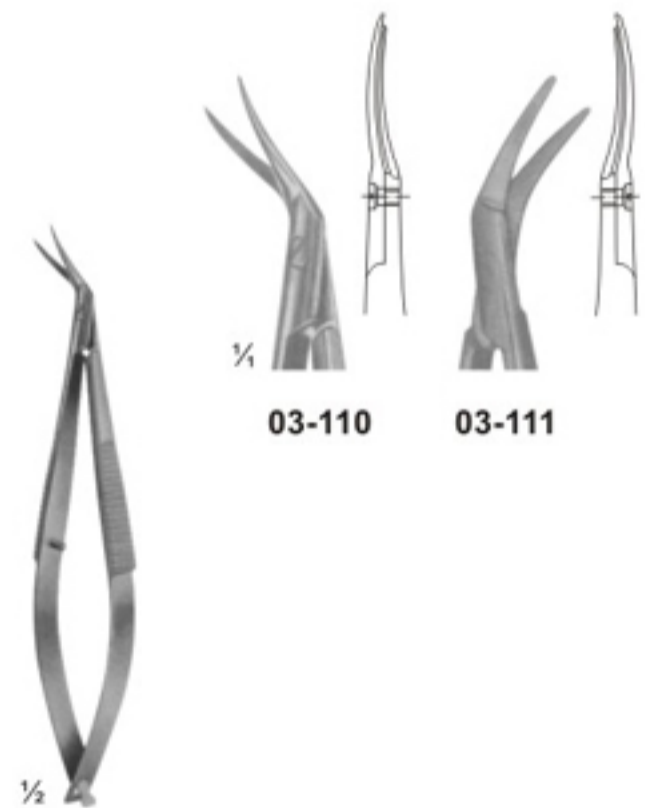

03-110 - 111
CASTROVIEJO
Eye scissor
Size: 110 mm

Micro Scissors (Spring Type) with Flat Handles

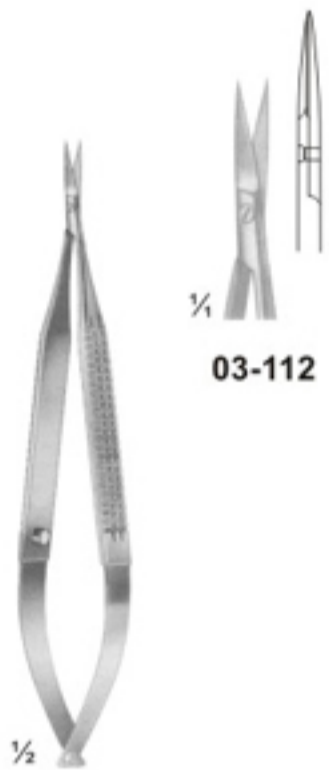

03-112

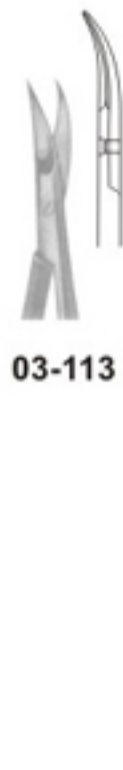

03-113

03-112 - 113
Size: 120 mm



03-114
BIEMER
Vein scissor
Size: 130 mm

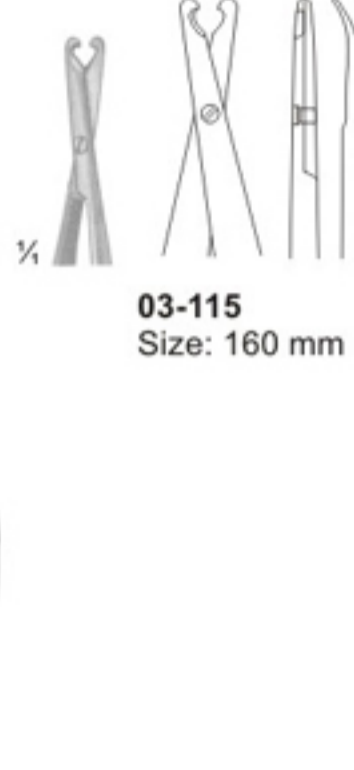

03-115
Size: 160 mm



03-116 - 117
VANNAS
Size: 160 mm



03-116



03-117

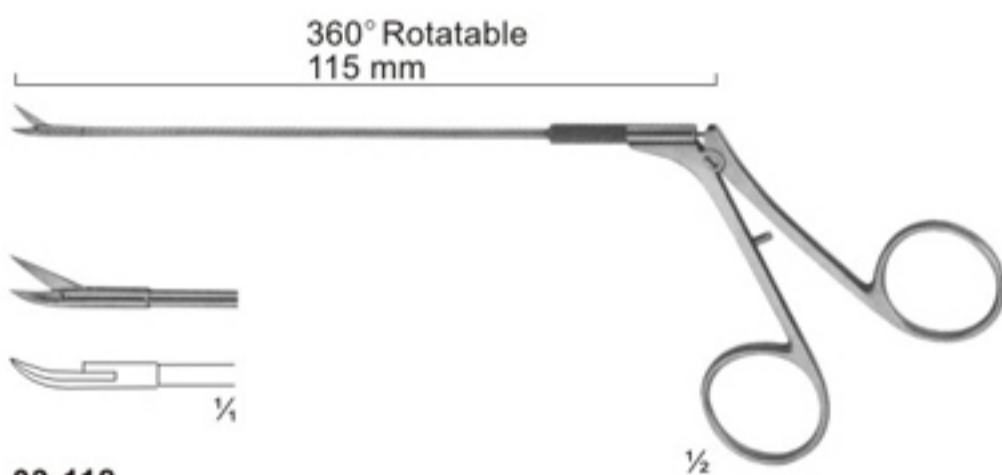

03-118
CASPAR
Micro scissor curved
Size: 115 mm



03-119 - 121
Micro dissecting scissor
Size: 145 mm



03-119



03-120



03-121

Micro Scissors (Spring Type) bayonet-Shaped



1/2
03-122
YASARGIL
Size: 245 mm



1/4
03-123
45°



1/4
03-124
45°



1/2
03-123 - 124
laterally angled
Size: 200 mm



125°



1/2
03-125
laterally angled
Size: 190 mm

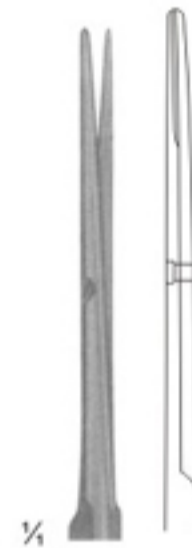

1/4
03-126

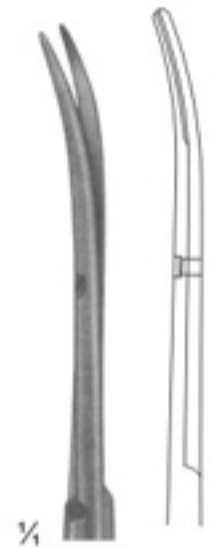

1/4
03-127



1/2
03-126 - 127
YASARGIL
Size: 225 mm

Delicate Scissors

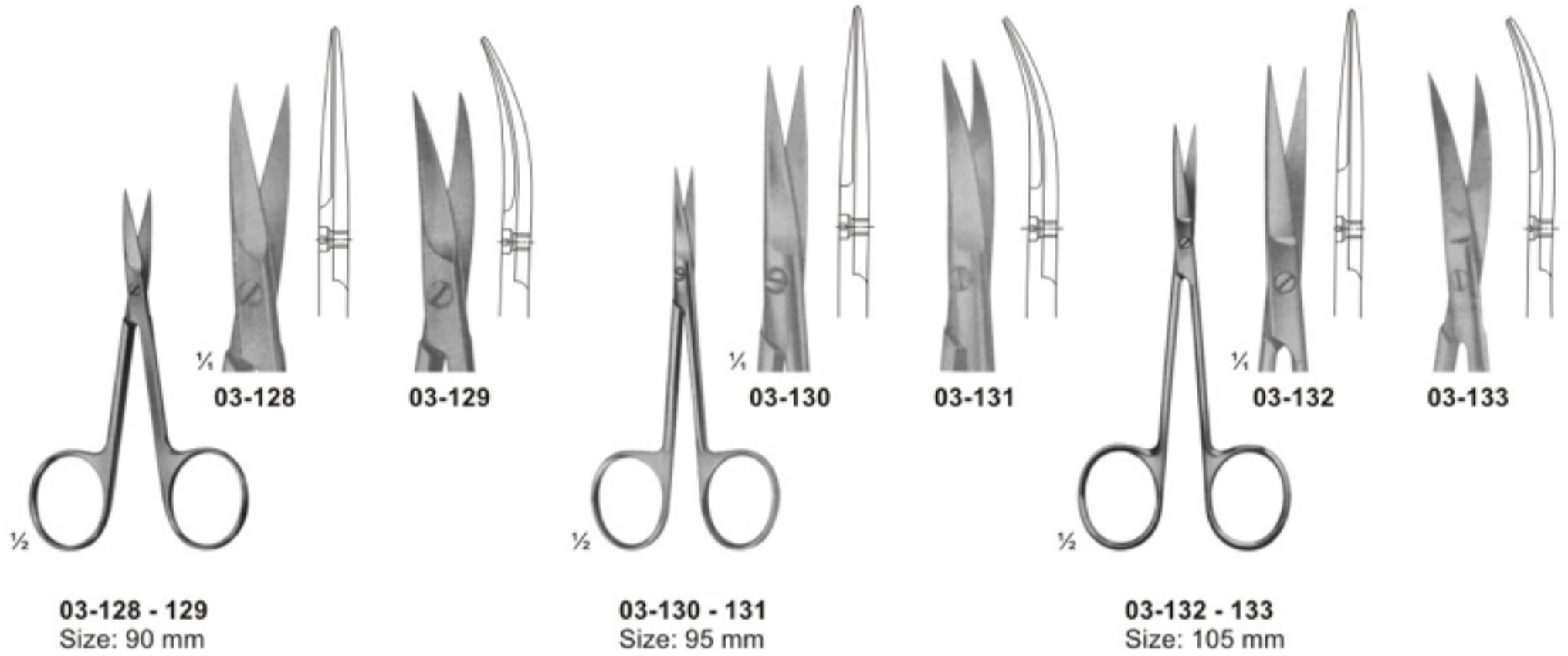

Delicate Scissors



03-138 - 140
Size: 120 mm

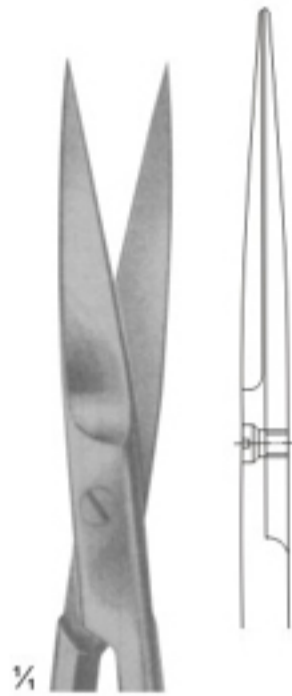

1/4

03-138

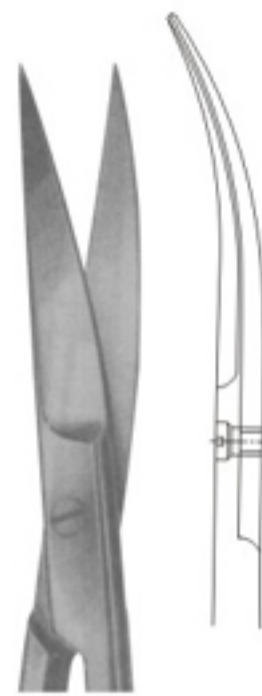

03-139

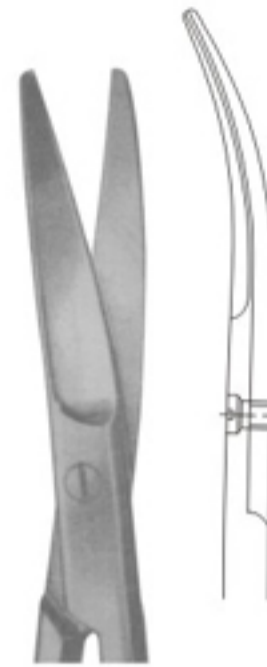

03-140



03-141 - 144
Size: 130 mm

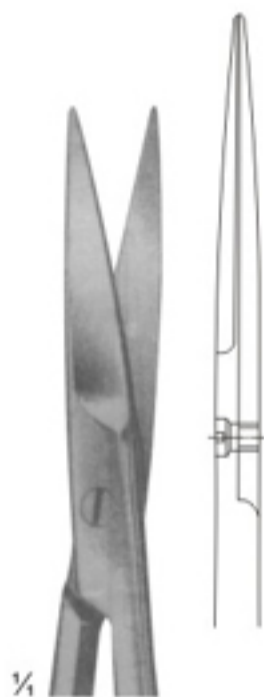

1/4

03-141

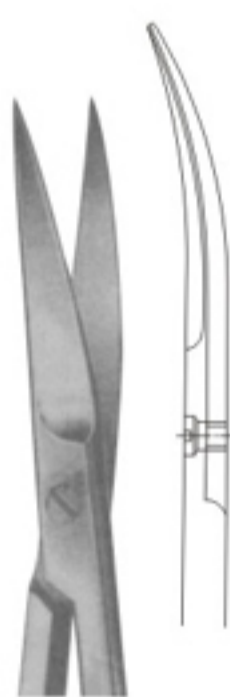

03-142

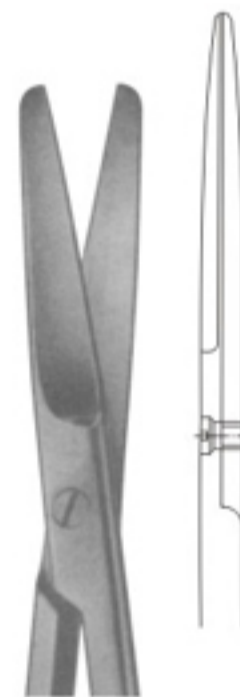

03-143

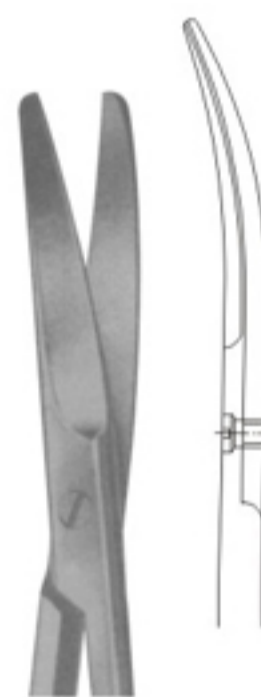

03-144

Surgical Scissors

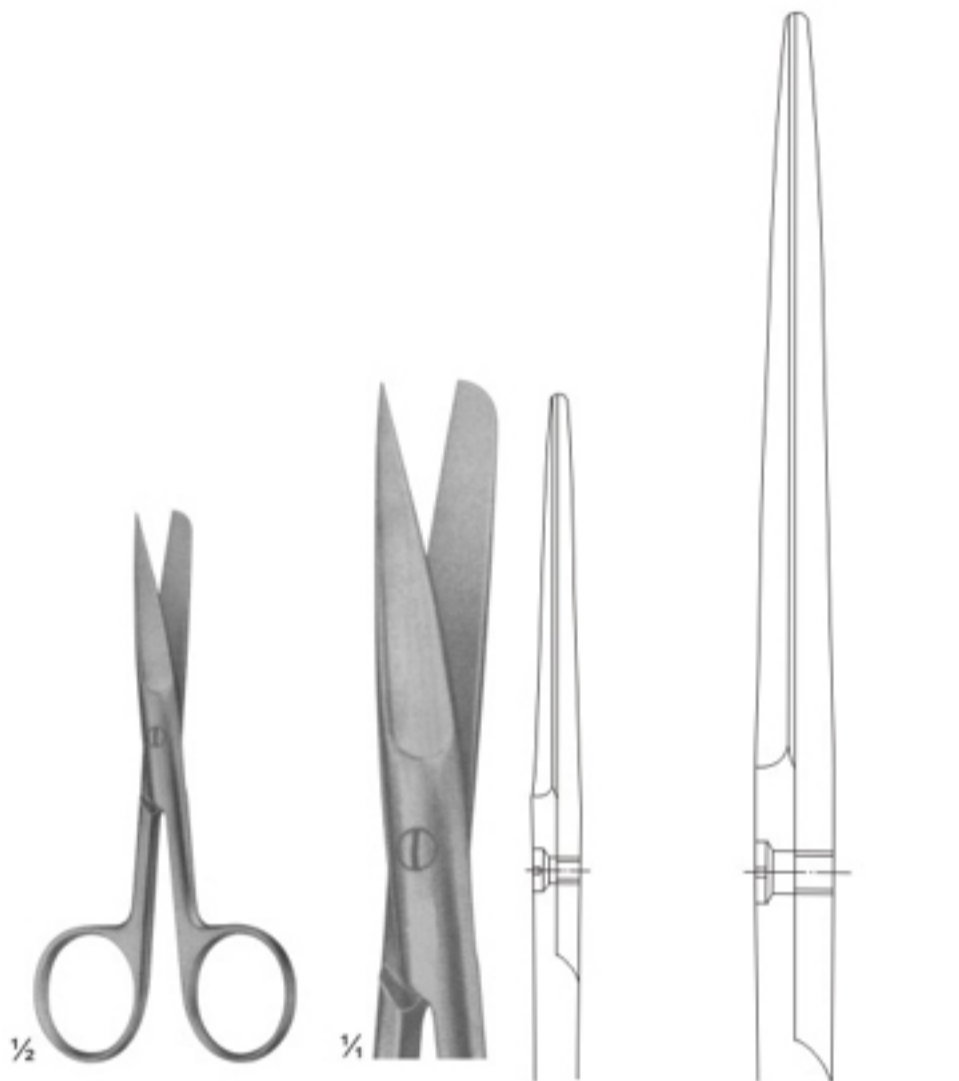

03-145 - 153 (Standard types)
 03-145 (105 mm)
 03-146 (115 mm)
 03-147 (130 mm)
 03-148 (145 mm)
 03-149 (150 mm)
 03-150 (165 mm)
 03-151 (175 mm)
 03-152 (185 mm)
 03-153 (200 mm)

03-145
 Size: 105 mm

03-153
 Size: 200 mm



03-154 - 160 (Standard types)
 03-154 (115 mm)
 03-155 (130 mm)
 03-156 (145 mm)
 03-157 (150 mm)
 03-158 (165 mm)
 03-159 (175 mm)
 03-160 (185 mm)

03-154
 Size: 115 mm

03-160
 Size: 185 mm

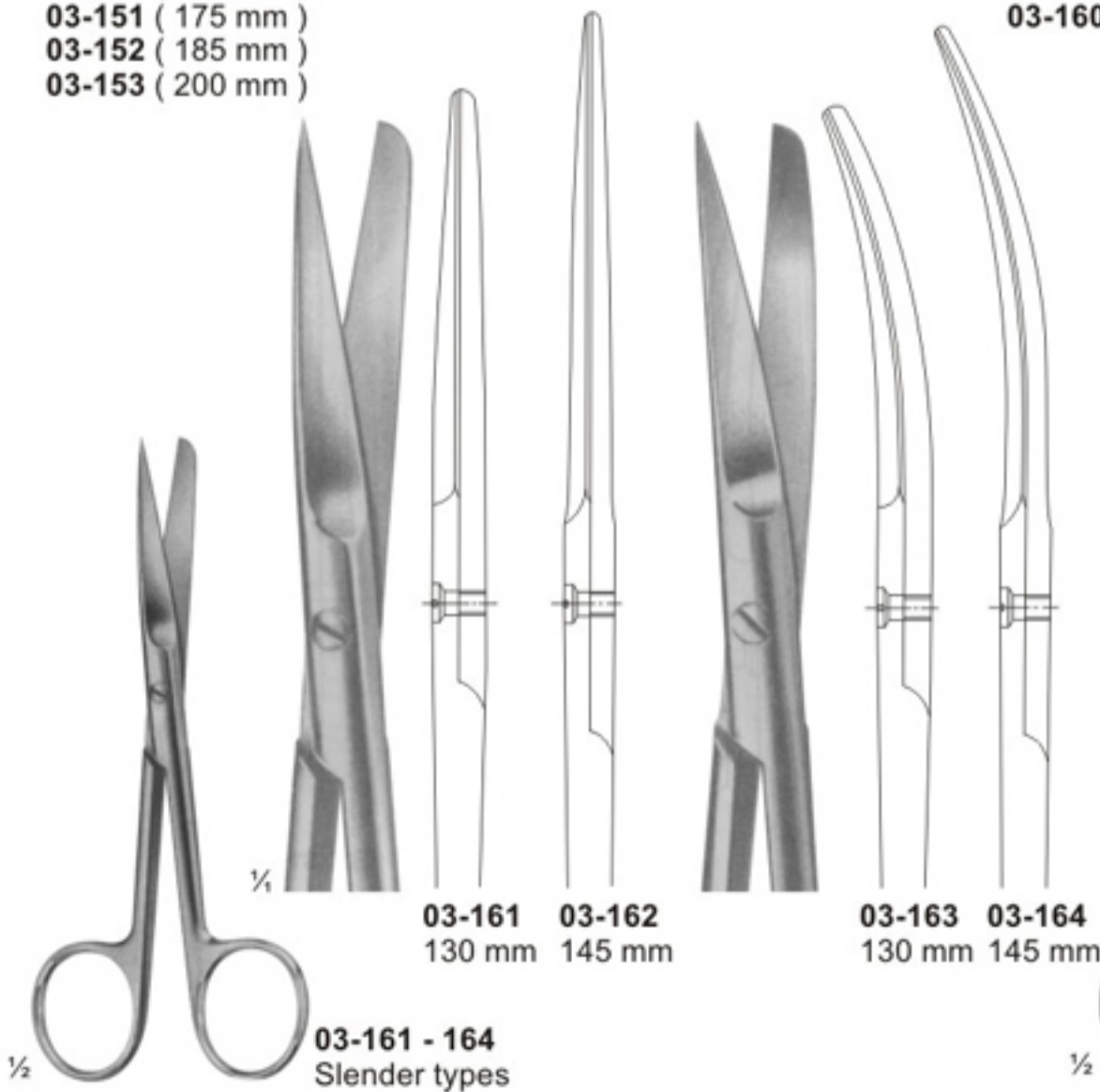

03-161 - 164
 Slender types

03-161
 130 mm

03-162
 145 mm

03-163
 130 mm

03-164
 145 mm

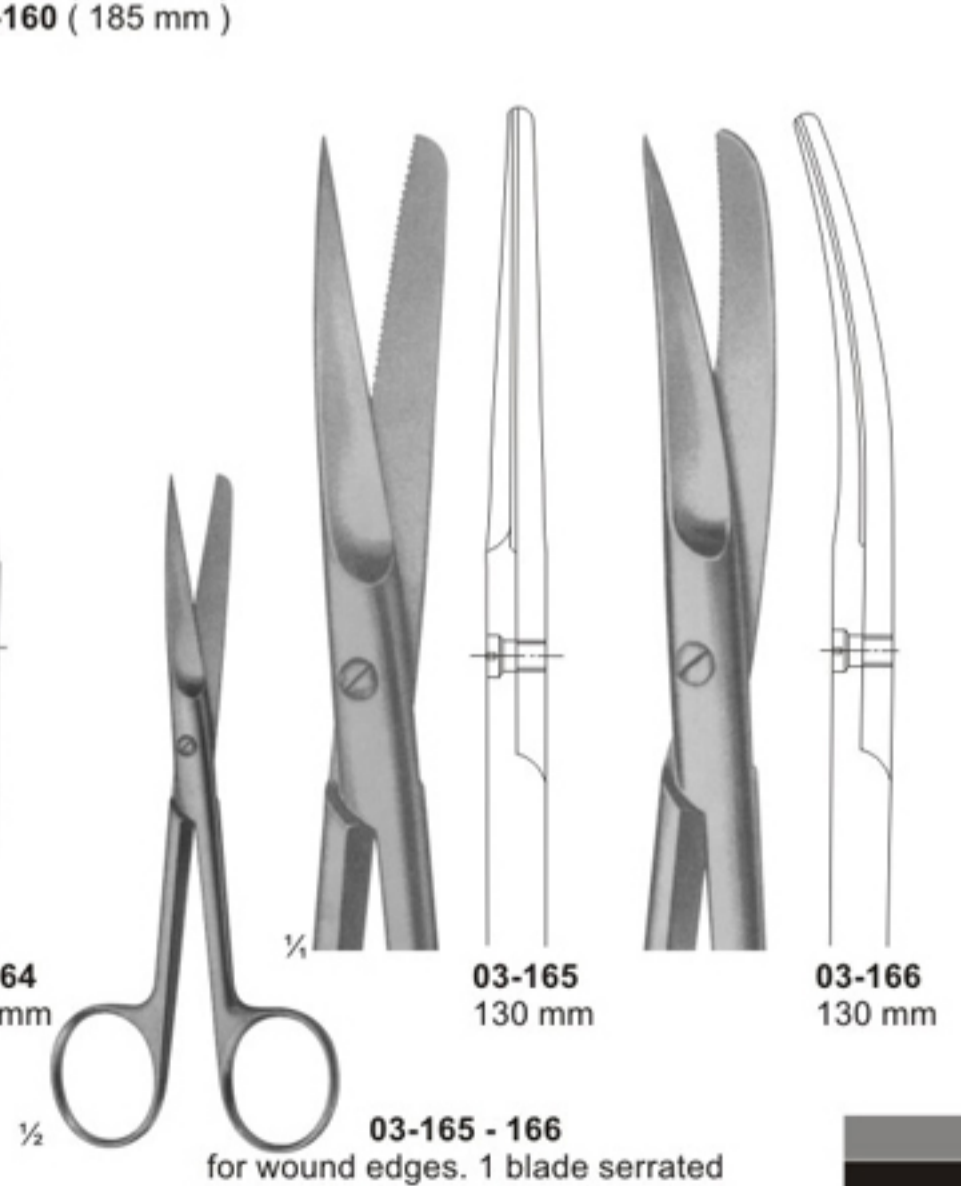

03-165 - 166
 for wound edges. 1 blade serrated

03-165
 130 mm

03-166
 130 mm

Surgical Scissors



03-167 - 169
DEAVER
with flat lock

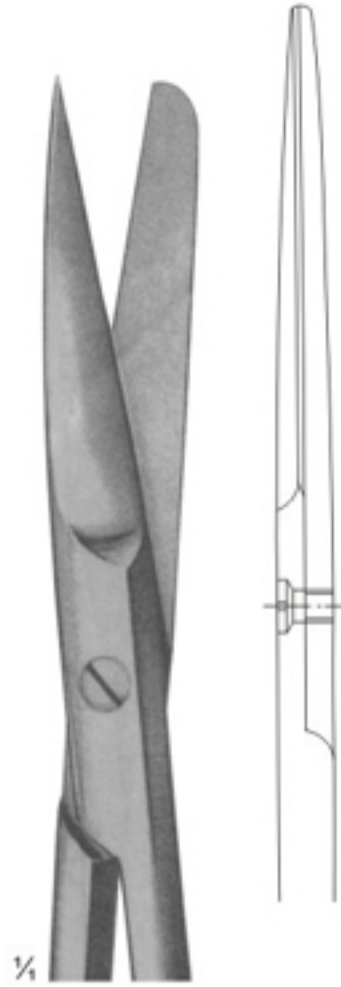

03-167
Size: 145 mm

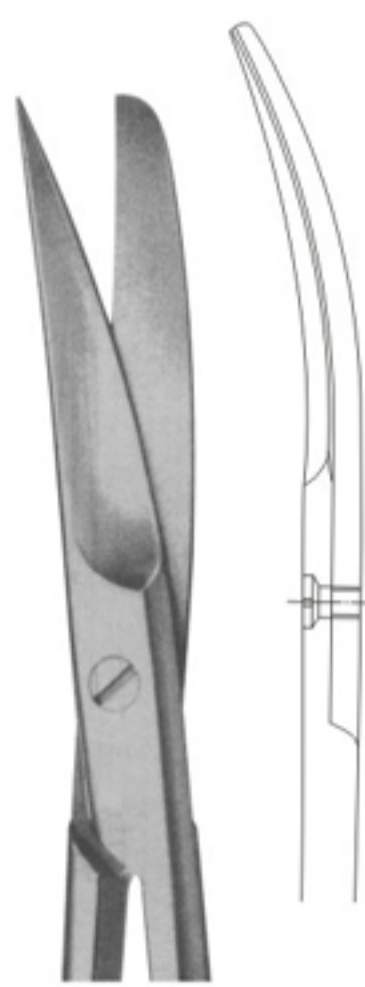

03-168
Size: 145 mm

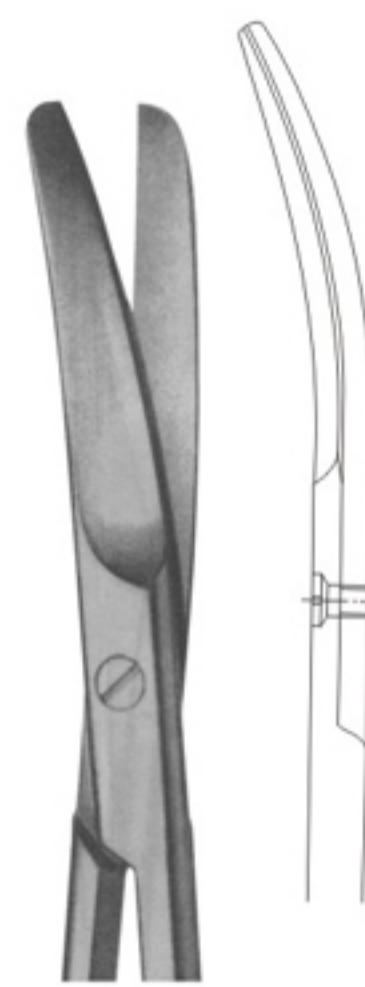

03-169
Size: 145 mm



03-170 - 172
Incision scissors

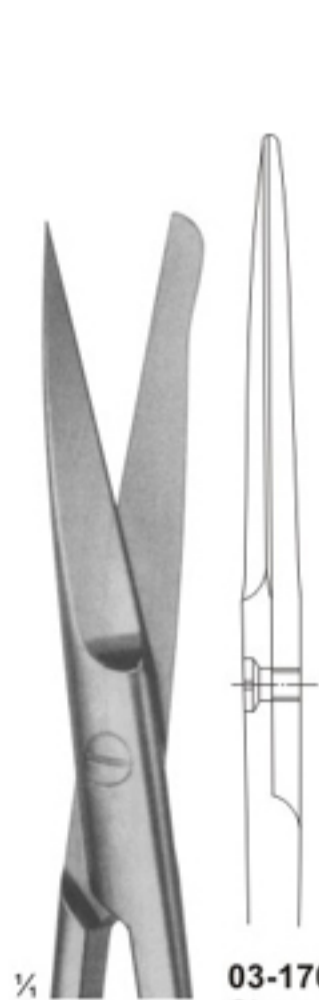

03-170
Size: 130 mm



03-171
Size: 145 mm



03-172
Size: 165 mm



03-173
SYSTRUNK
Nail splitting scissors

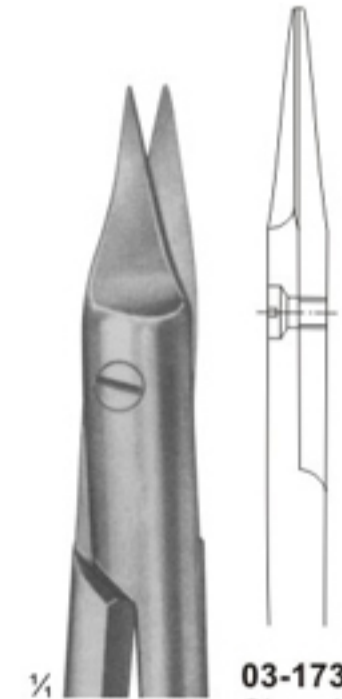

03-173
Size: 130 mm

Dissecting Scissors

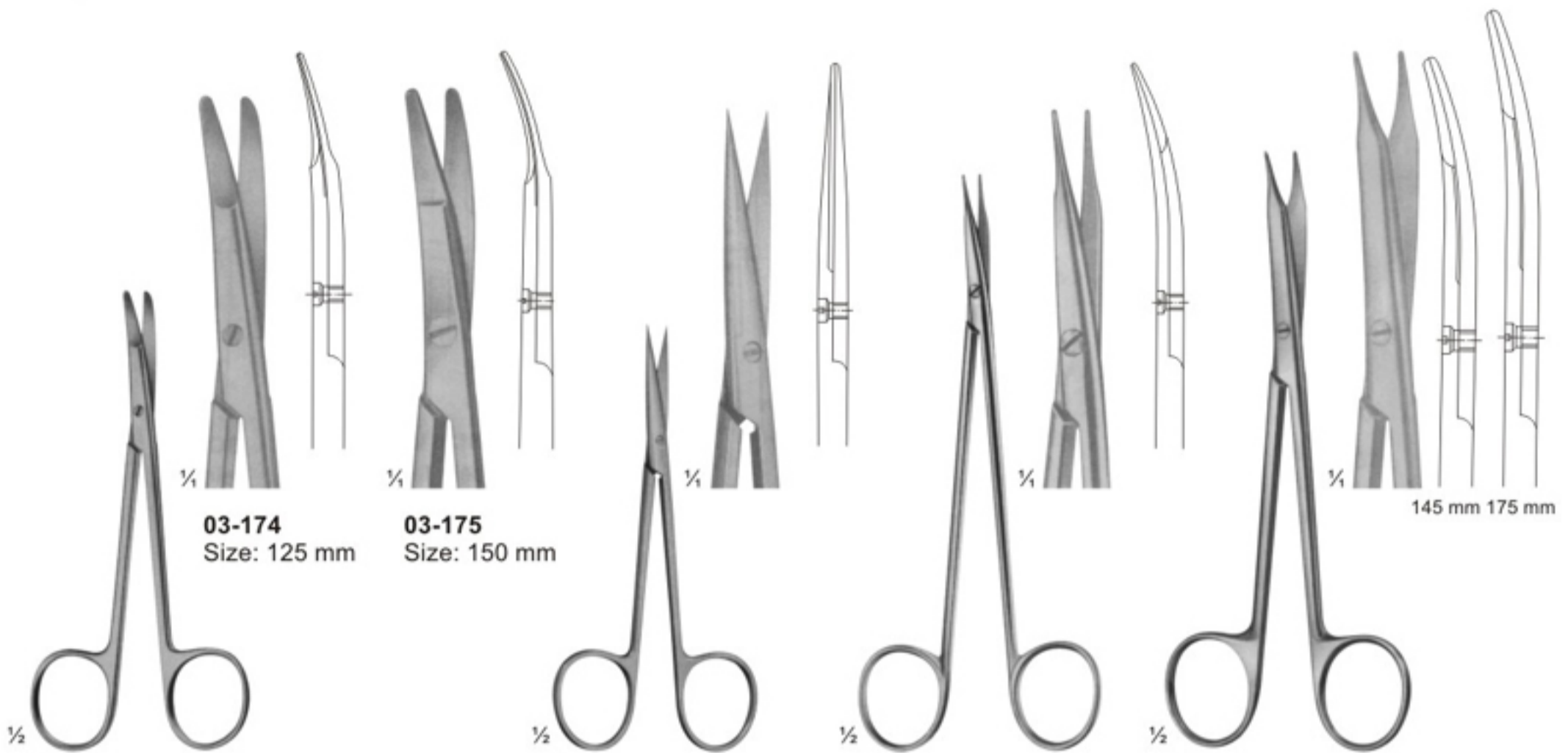

03-174 - 175
KILNER
 Special flat points for dissecting and undermining the skin

03-176
KILNER
 Fine dissecting scissors
 Size: 115 mm

03-177
JAMESON
 Dissecting scissors
 Size: 150 mm

03-178
REYNOLDS
 Dissecting scissors
 Size: 145 - 175 mm

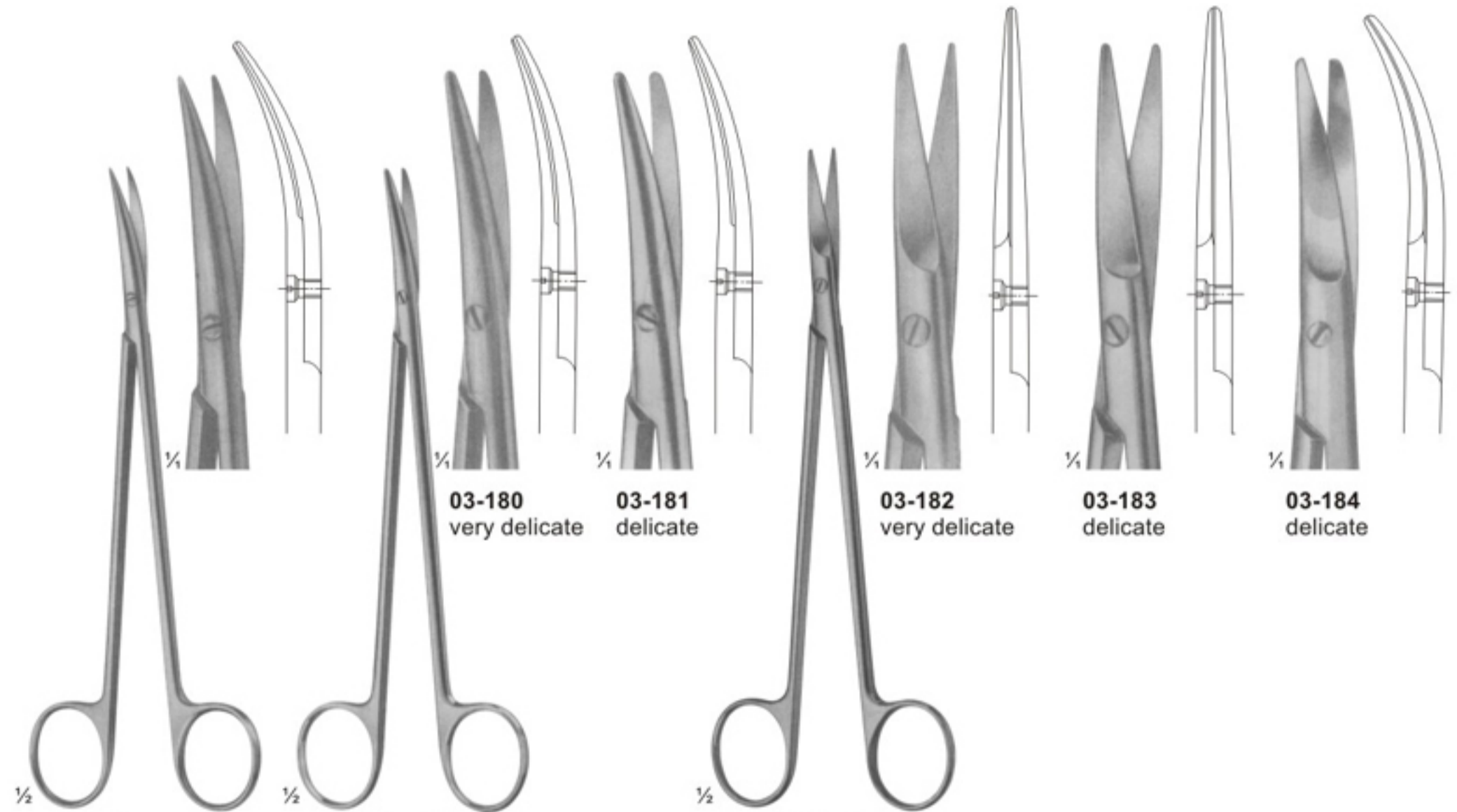

03-179
DE BAKEY
 Arteriotomy scissors
 Size: 175 mm

03-180 - 181
TOENNIS ADSON
 Dissecting scissors
 Size: 175 mm

03-182 - 184
TOENNIS
 Dissecting scissors
 Size: 180 mm

Dissecting Scissors

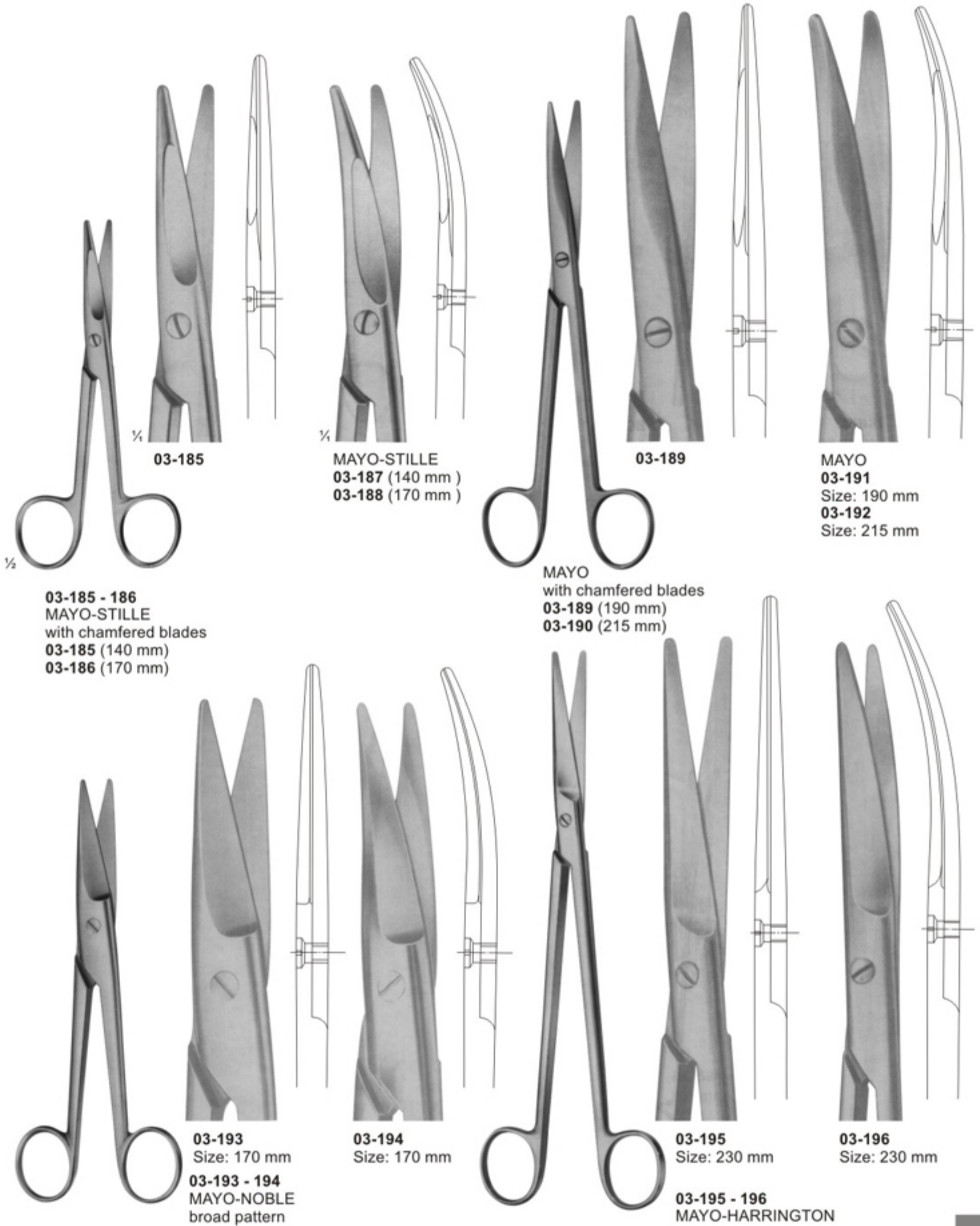

Scissors for Cardiovascular and Neuro-Surgery



03-197
OLIVECRONA
Dura scissors

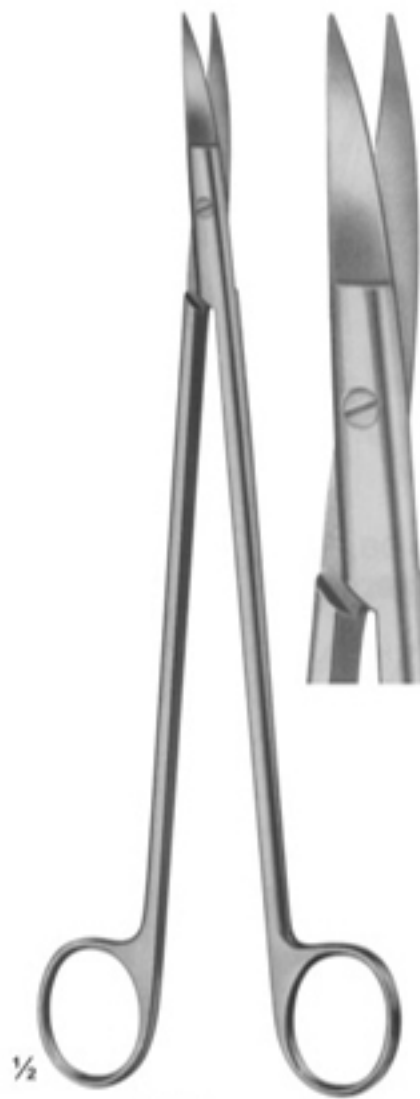

03-198
STRULLY
pointed
Size: 220 mm

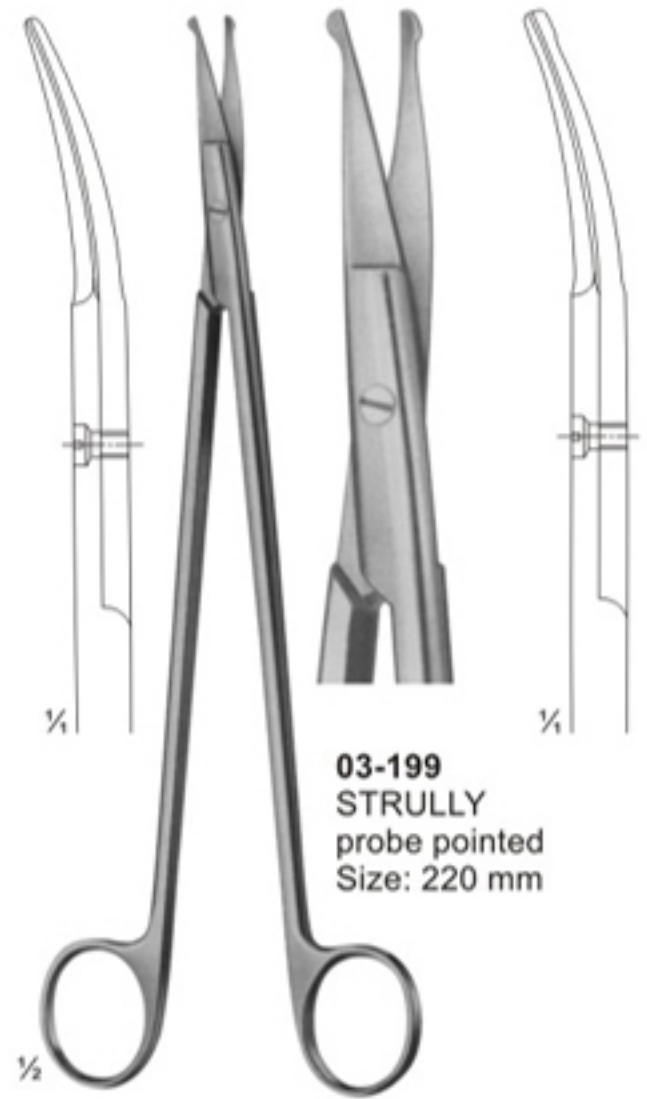

03-199
STRULLY
probe pointed
Size: 220 mm

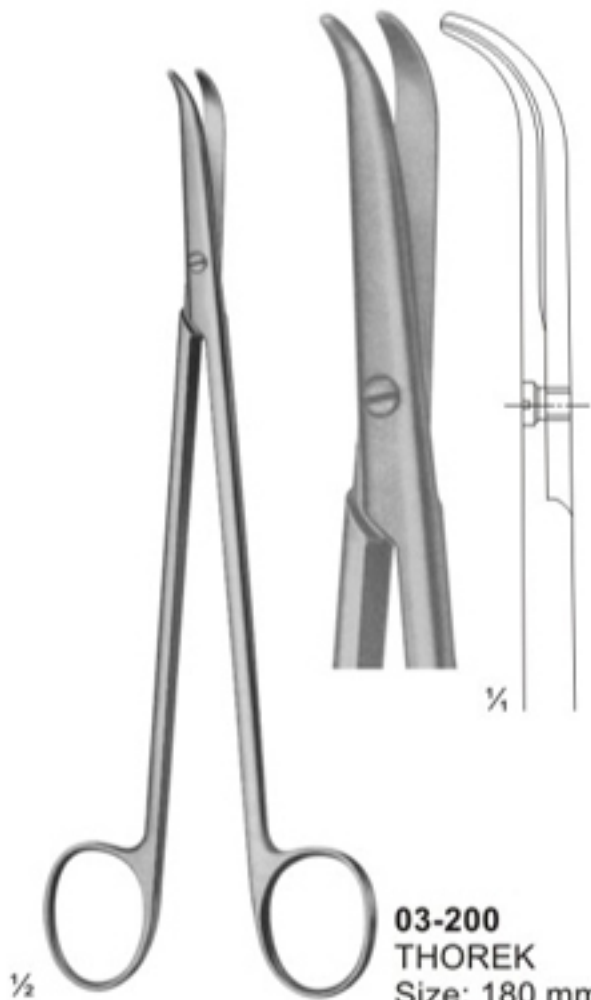

03-200
THOREK
Size: 180 mm

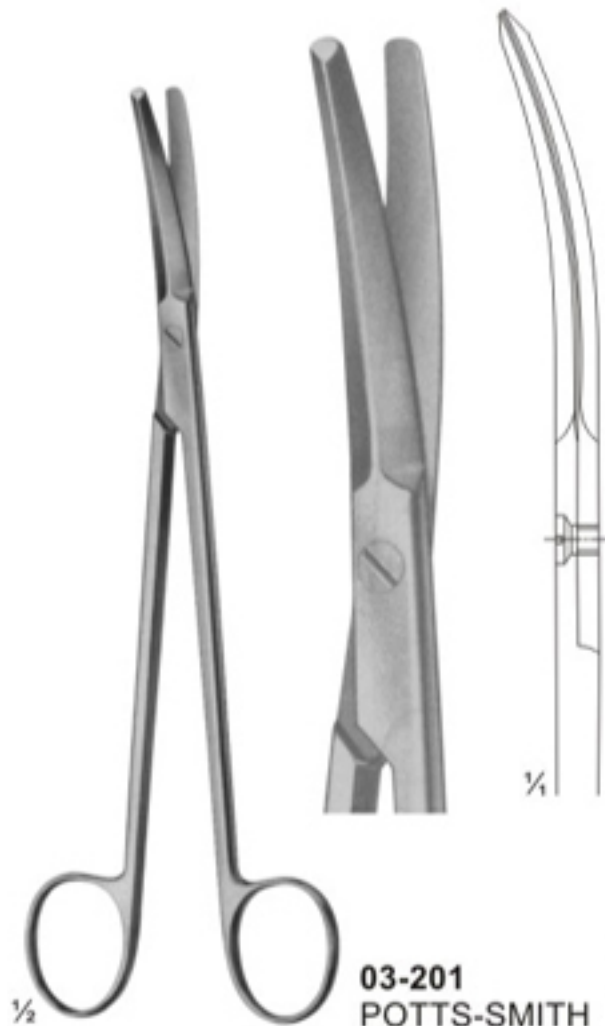

03-201
POTTS-SMITH
Size: 190 mm

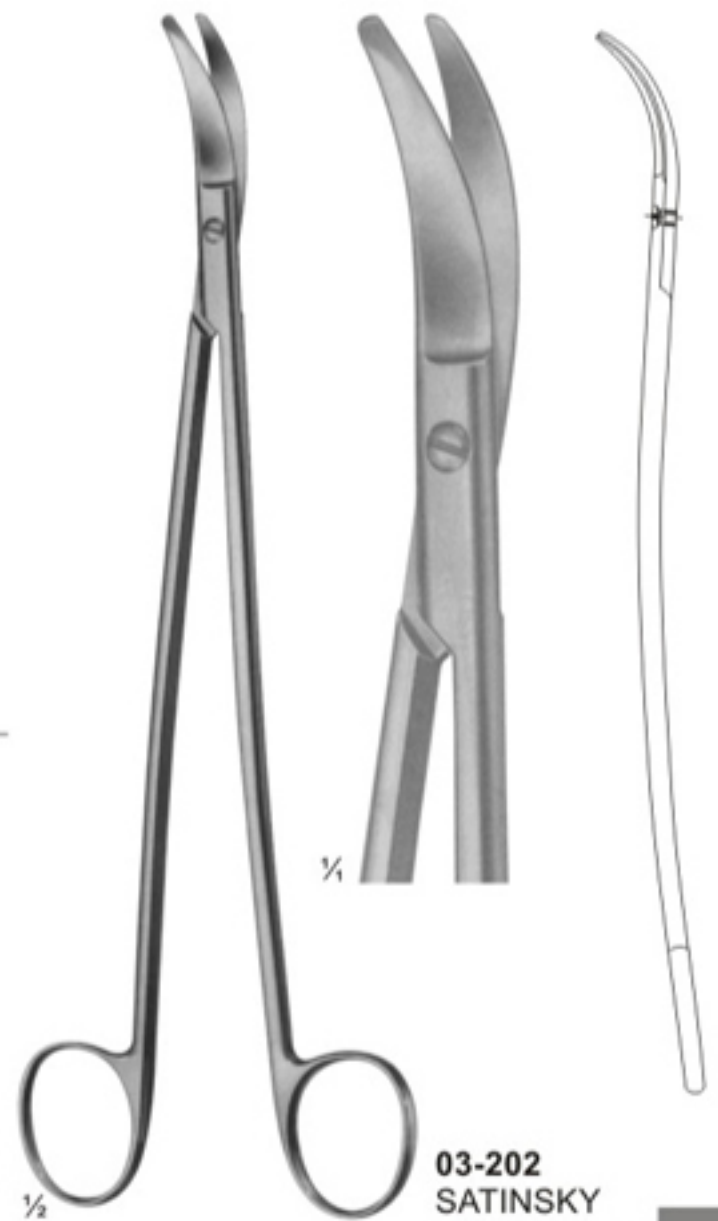

03-202
SATINSKY
Size: 245 mm

Delicate, Nasal and Tonsil Scissors



03-203
1 finely toothed blade
Size: 130 mm

03-204
LOCKLIN
curved sideways,
1 toothed blade
Size: 155 mm

03-205
FOMON
blades serrated
Size: 145 mm

03-206
COTTLE
Size: 165 mm

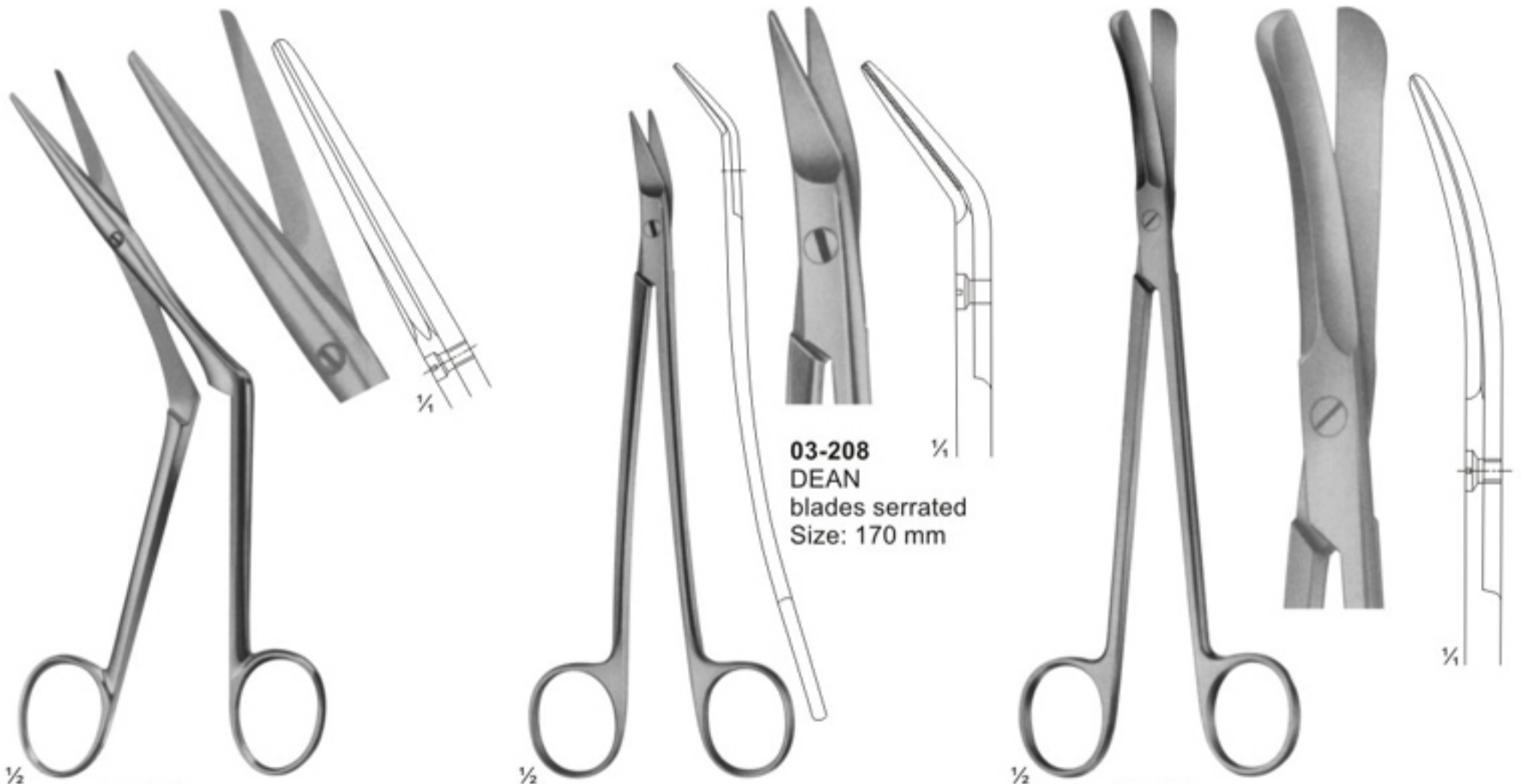

03-207
HEYMANN-KNIGHT
Size: 175 mm

03-208
DEAN
blades serrated
Size: 170 mm

03-209
GOOD
Size: 195 mm

Bone Shears

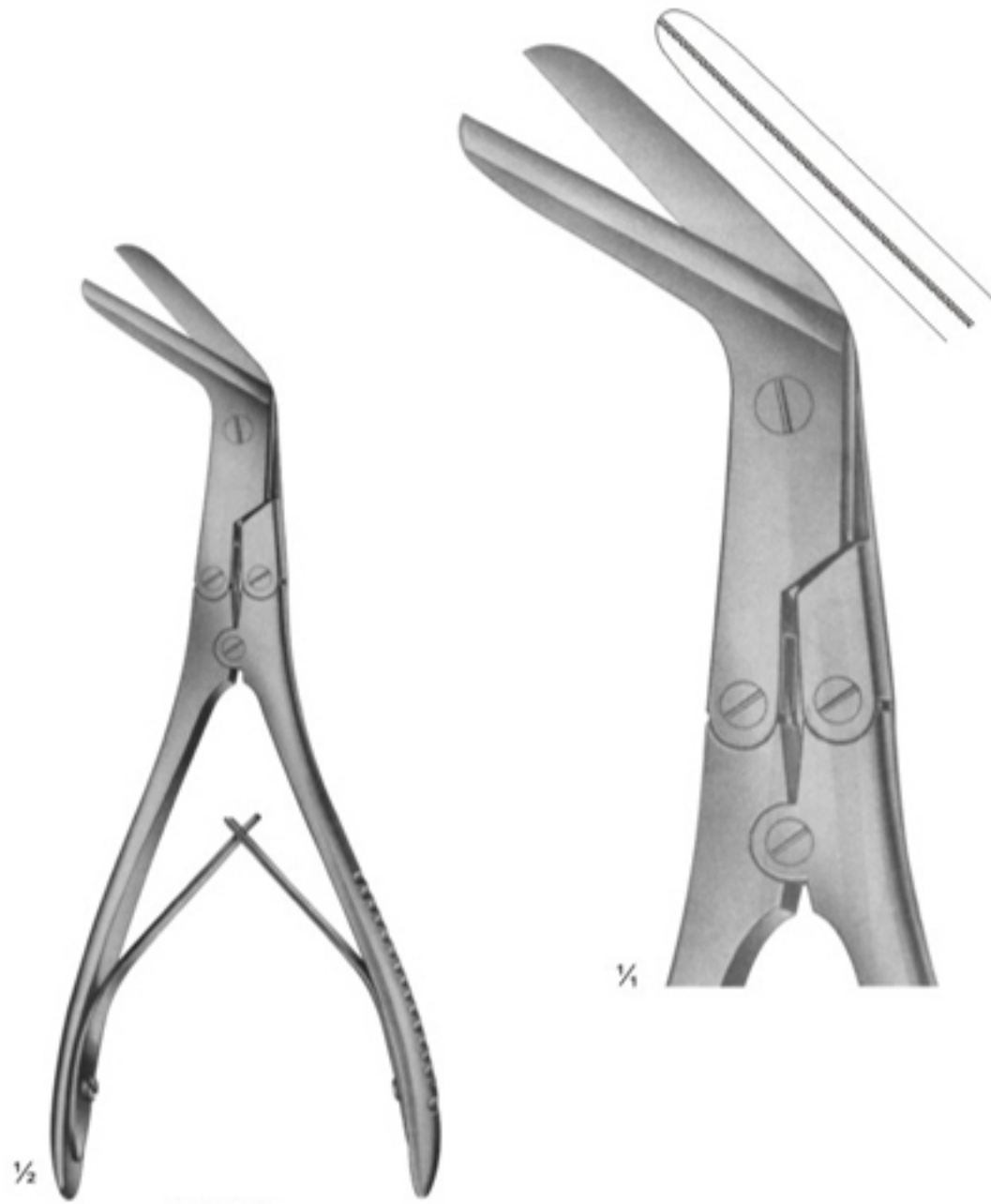

03-210
KILLIAN
Size: 200 mm



03-211 - 03-212

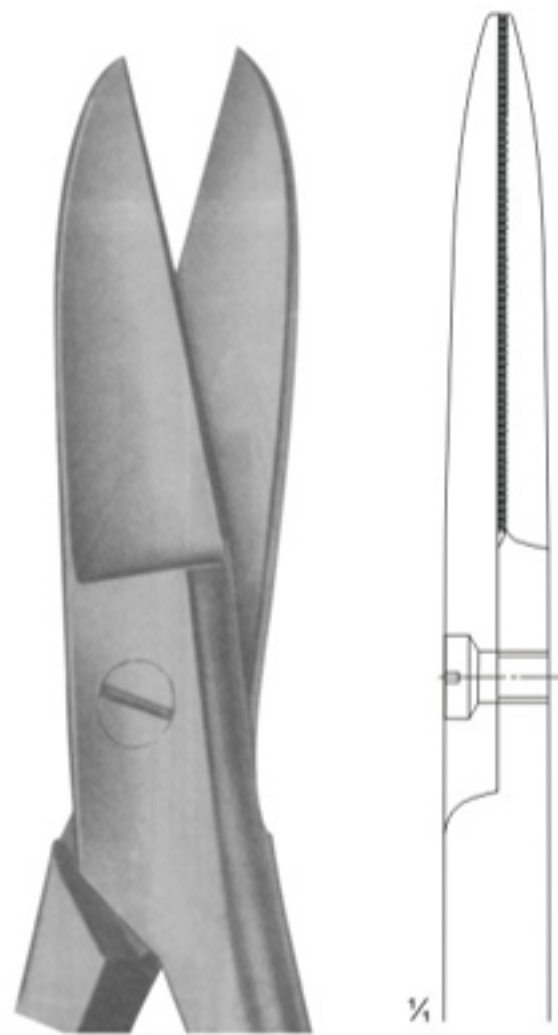

03-211
195 mm

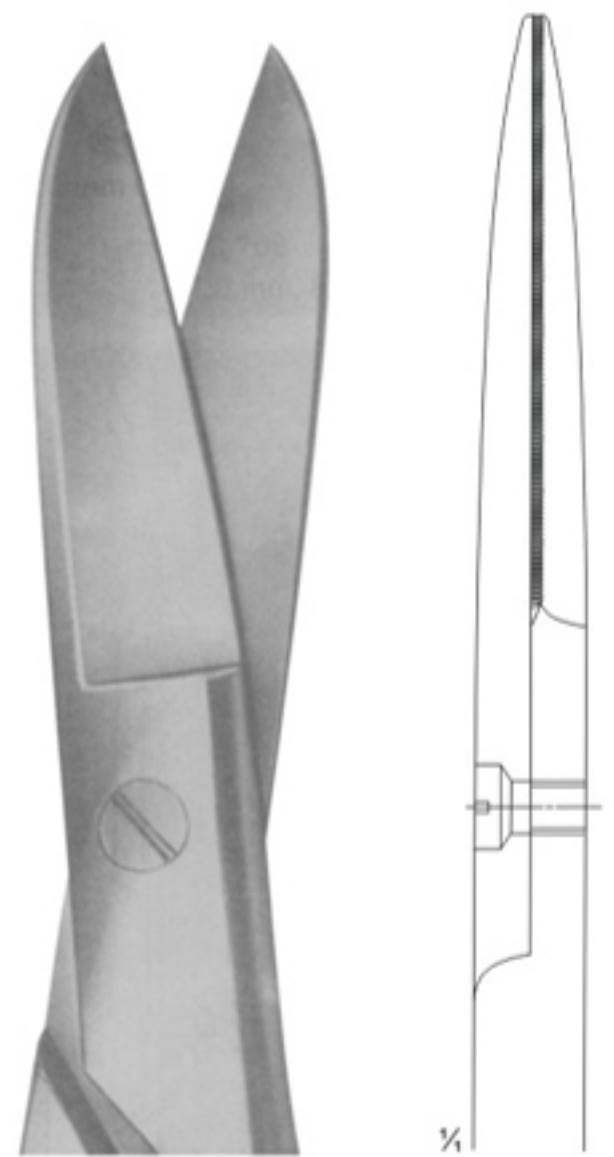

03-212
225 mm

Scissors for deep operations and
for Gynaecology

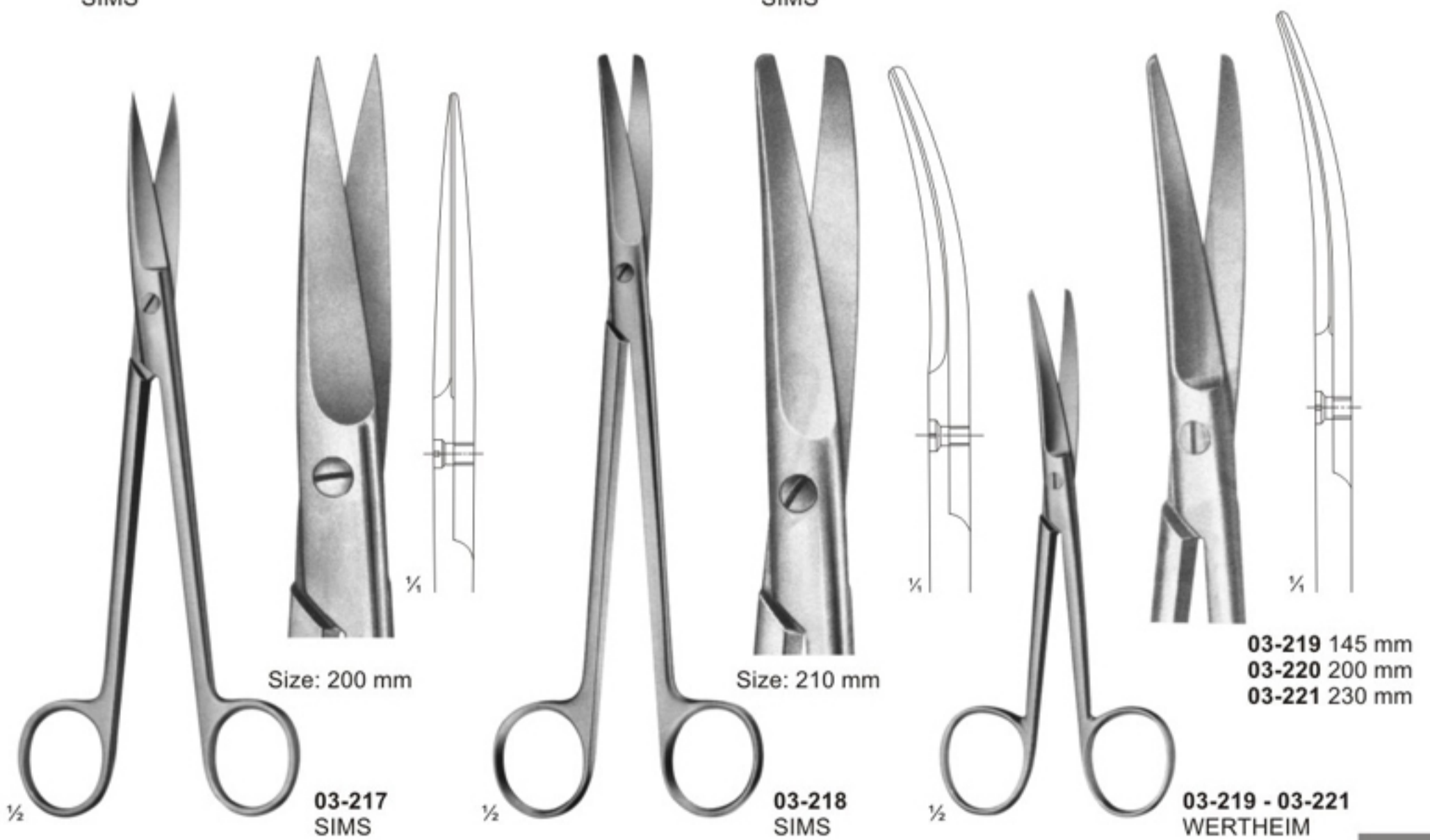
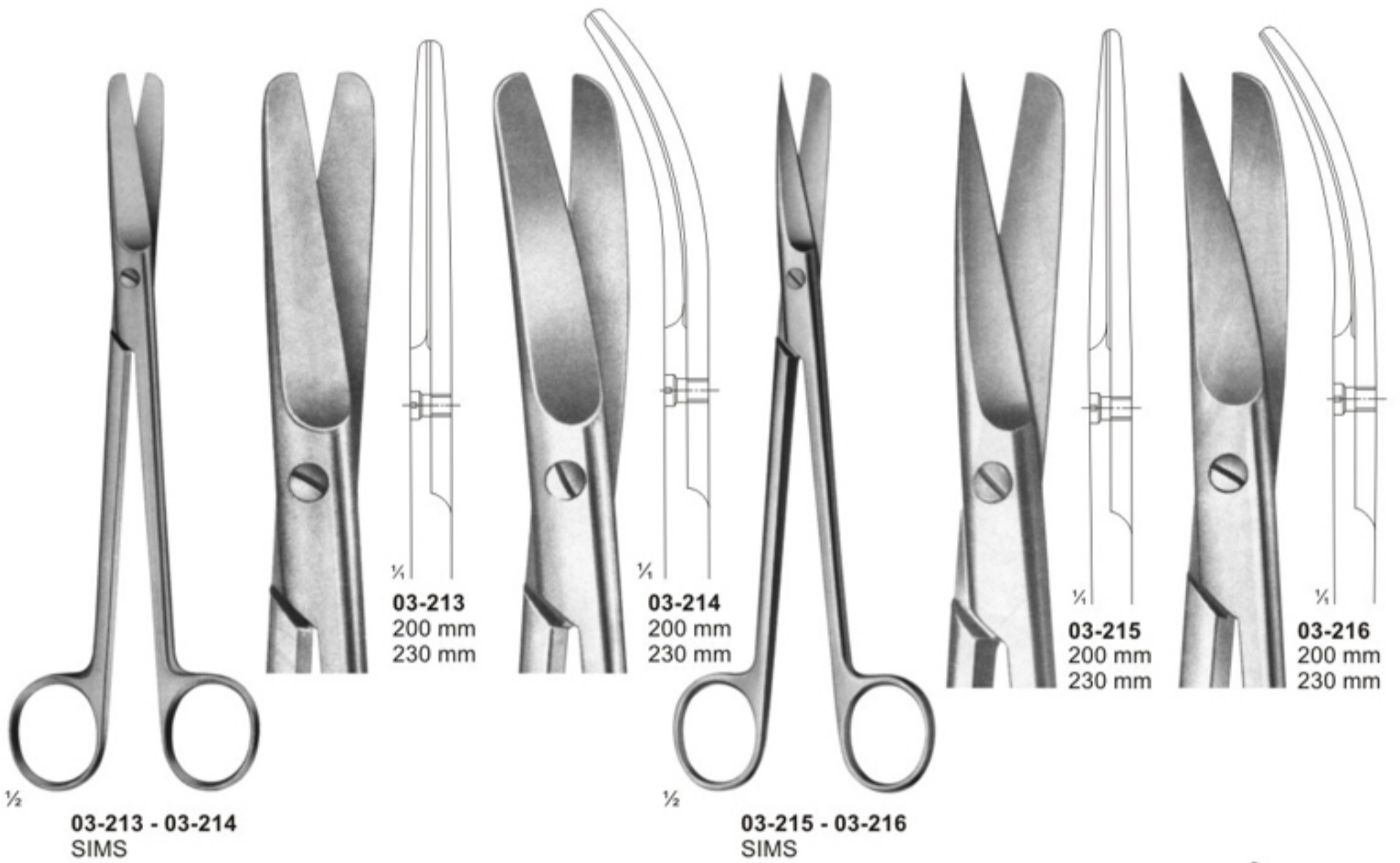

Scissors for Obstetrics



Wire and Plate Scissors

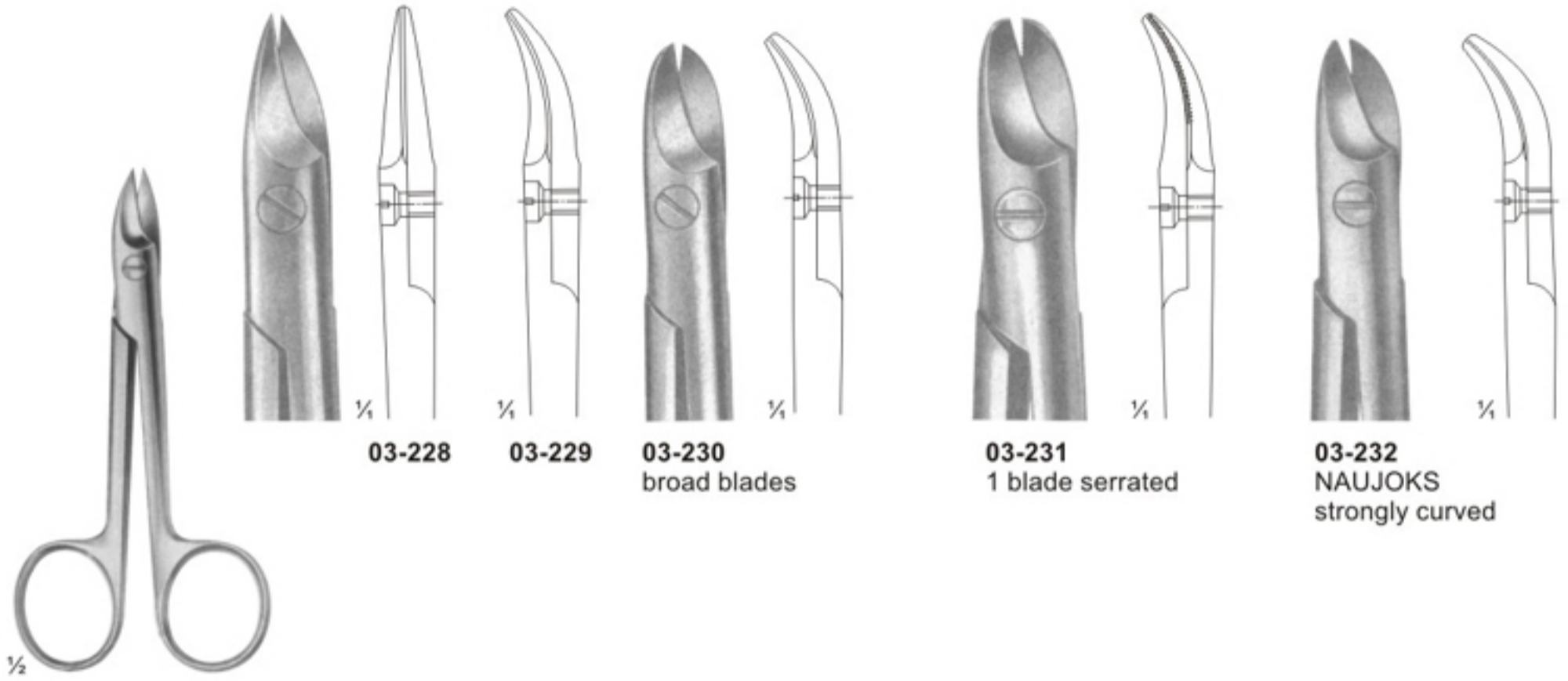

03-228

03-229

03-230
broad blades

03-231
1 blade serrated

03-232
NAUJOKS
strongly curved

03-228 - 03-232
BEEBE
Size: 110 mm

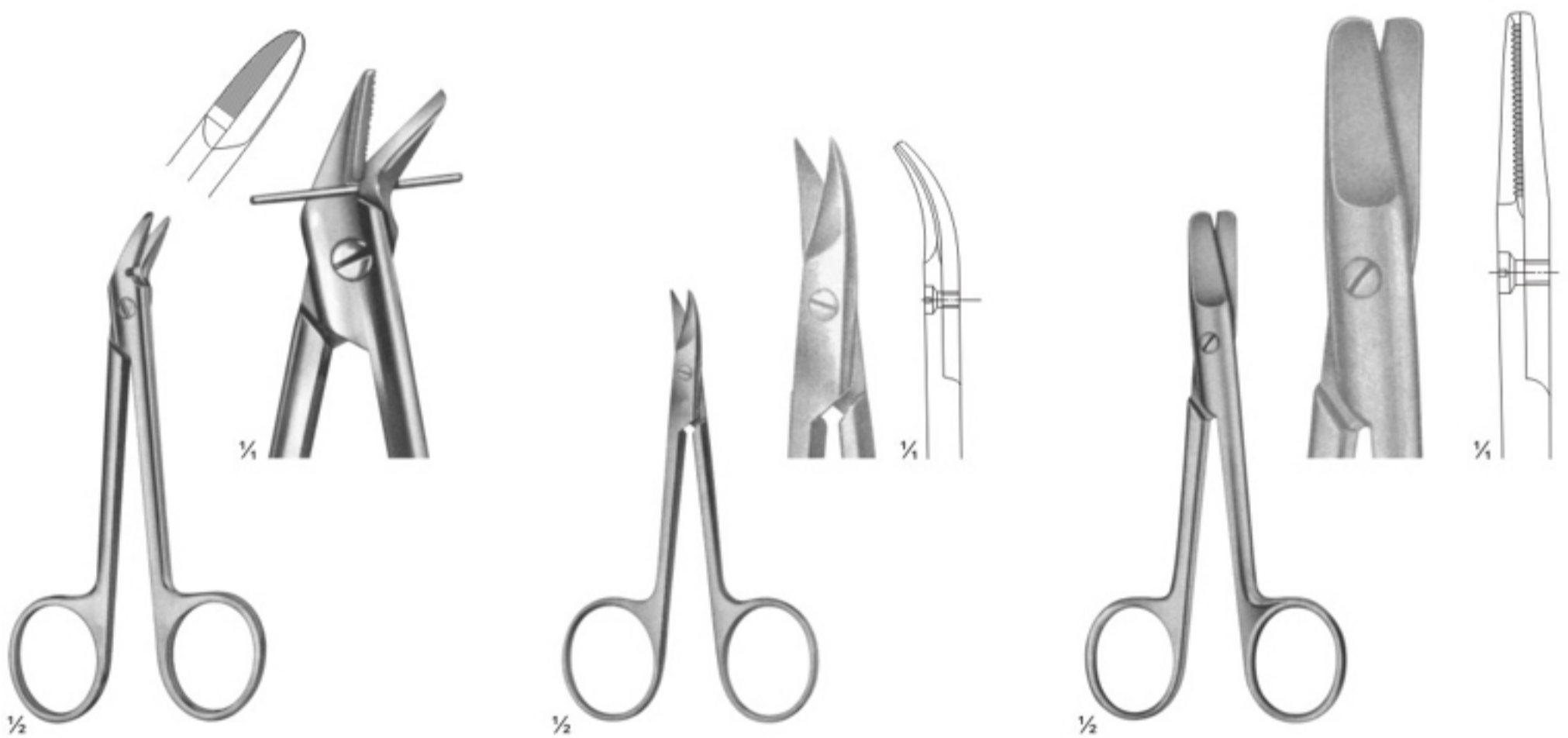

1/2

1/2

1/2

1/2

1/2

1/2

03-233
1 blade serrated
Size: 120 mm

03-234
STRACK
Size: 100 mm

03-235
HARVEY
blades serrated
Size: 125 mm

Bandage and Cloth Scissors



03-236
 Universal bandage and cloth scissors,
 with toothed edges
 180 mm

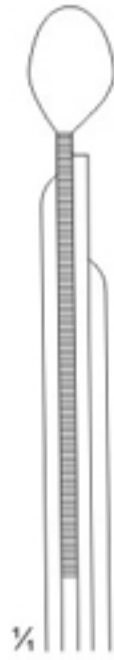

03-237
 LISTER
 Universal bandage and cloth scissors,
 with toothed edges
 Size: 145 mm

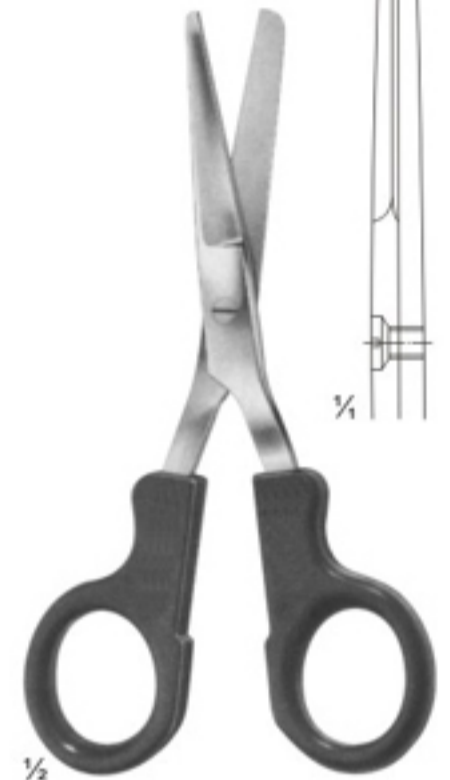
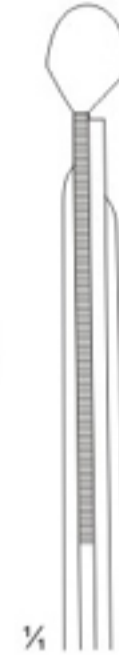

03-238
 LISTER
 Nurse's scissors
 Size: 145 mm



03-239 - 03-242
 LISTER

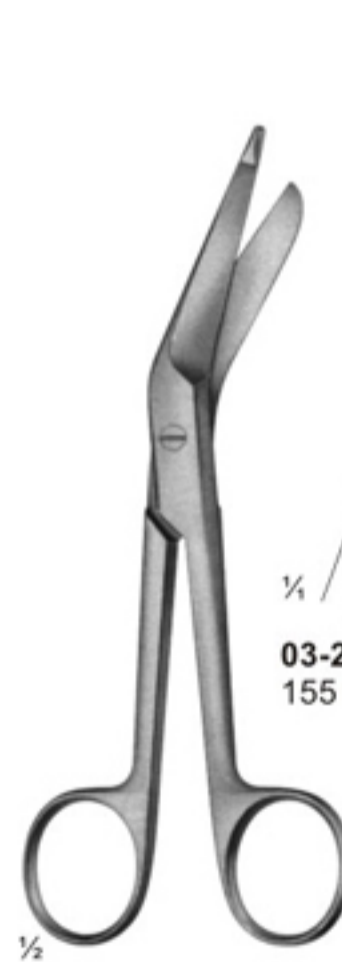
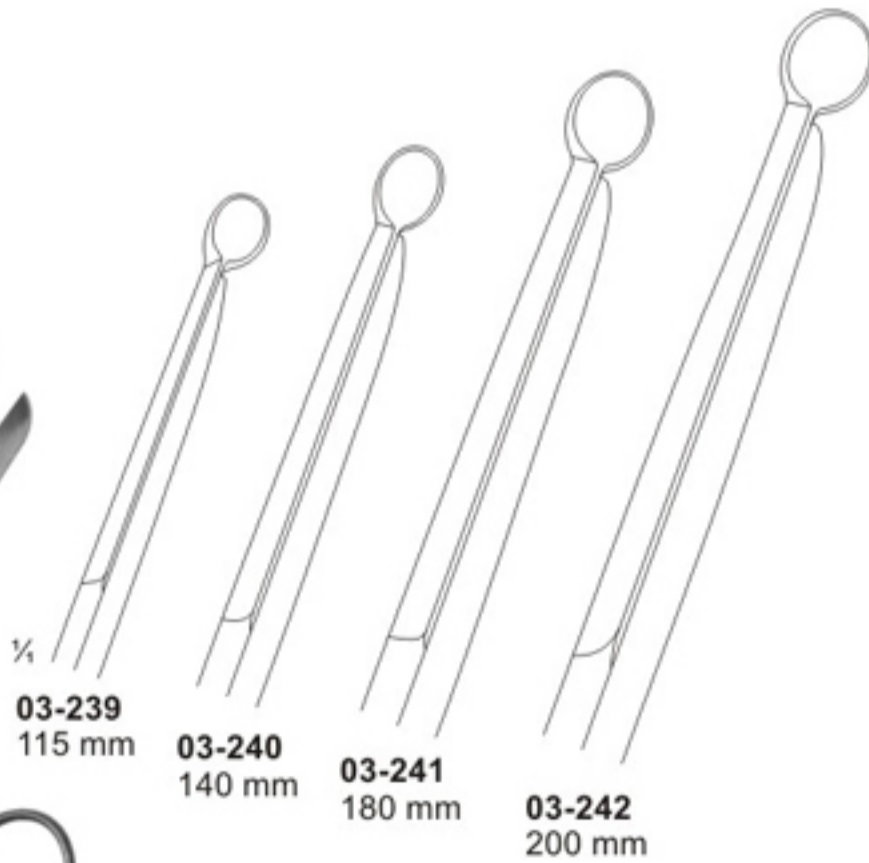

03-243 - 03-244
 LISTER

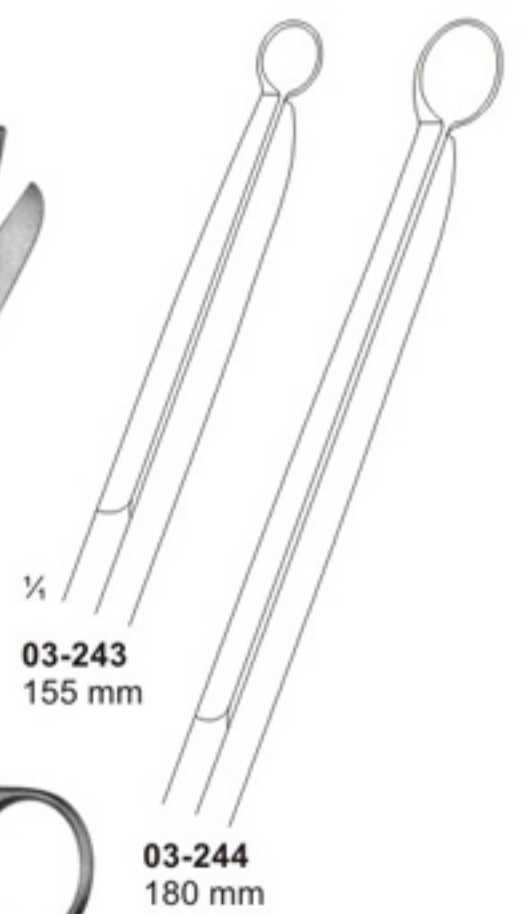

Bandage-, Cloth-, and Plaster Scissors



03-245
CLOTH SCISSORS
205 mm

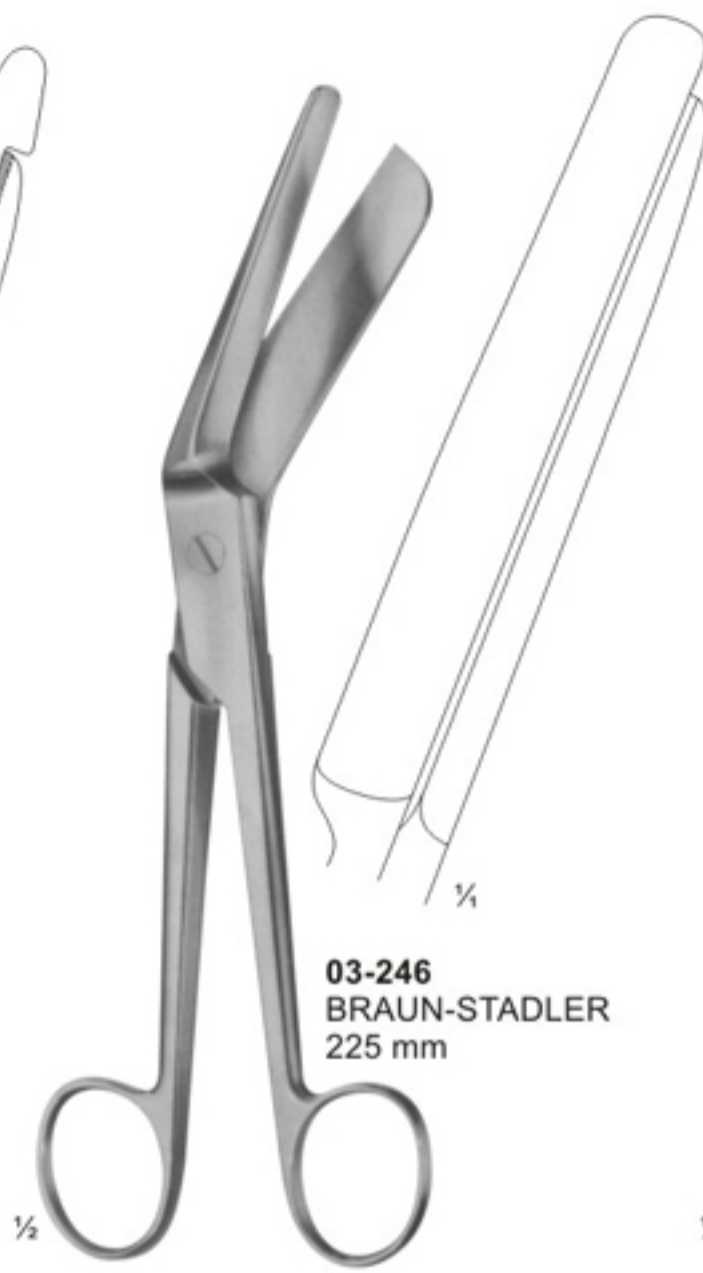

03-246
BRAUN-STADLER
225 mm



03-247
SEUTIN
230 mm

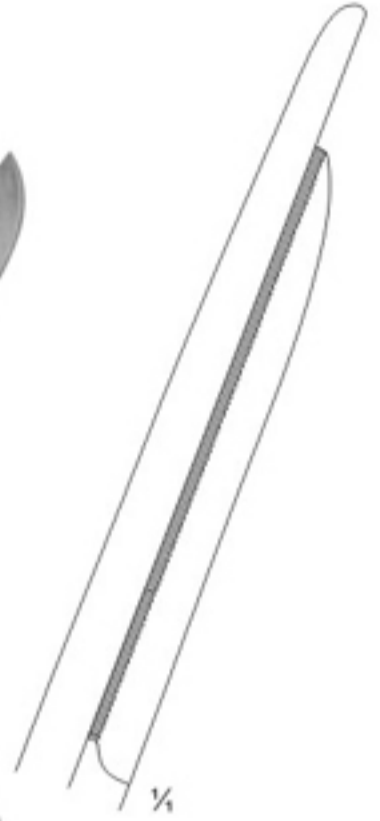

03-248 **03-249**
200 mm 230 mm

03-248 - 03-249
ESMARCH

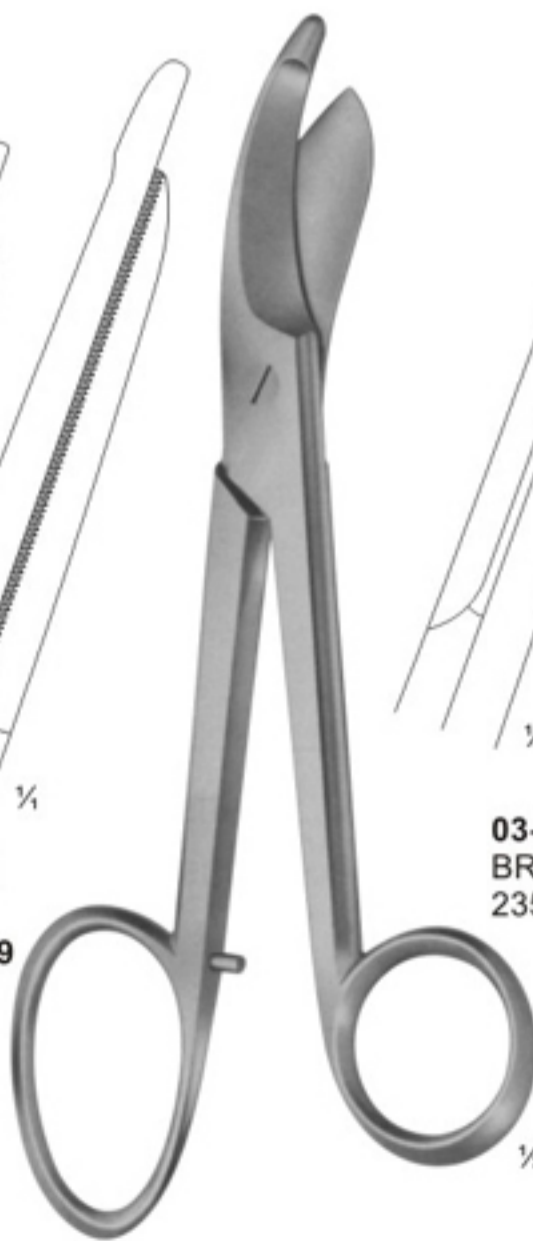

03-250
BRUNS
235 mm



03-251
Bandage Scissors
235 mm

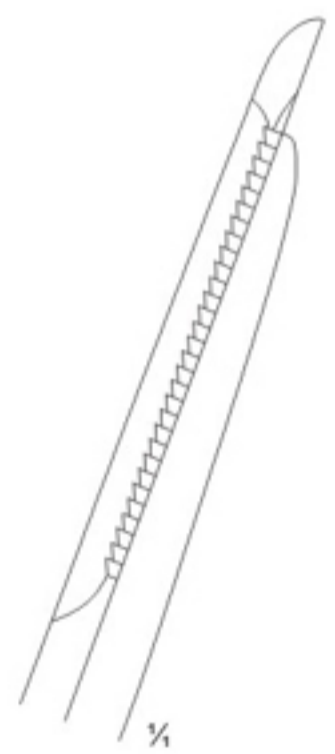

Forceps for grasping tissue, tumors etc.

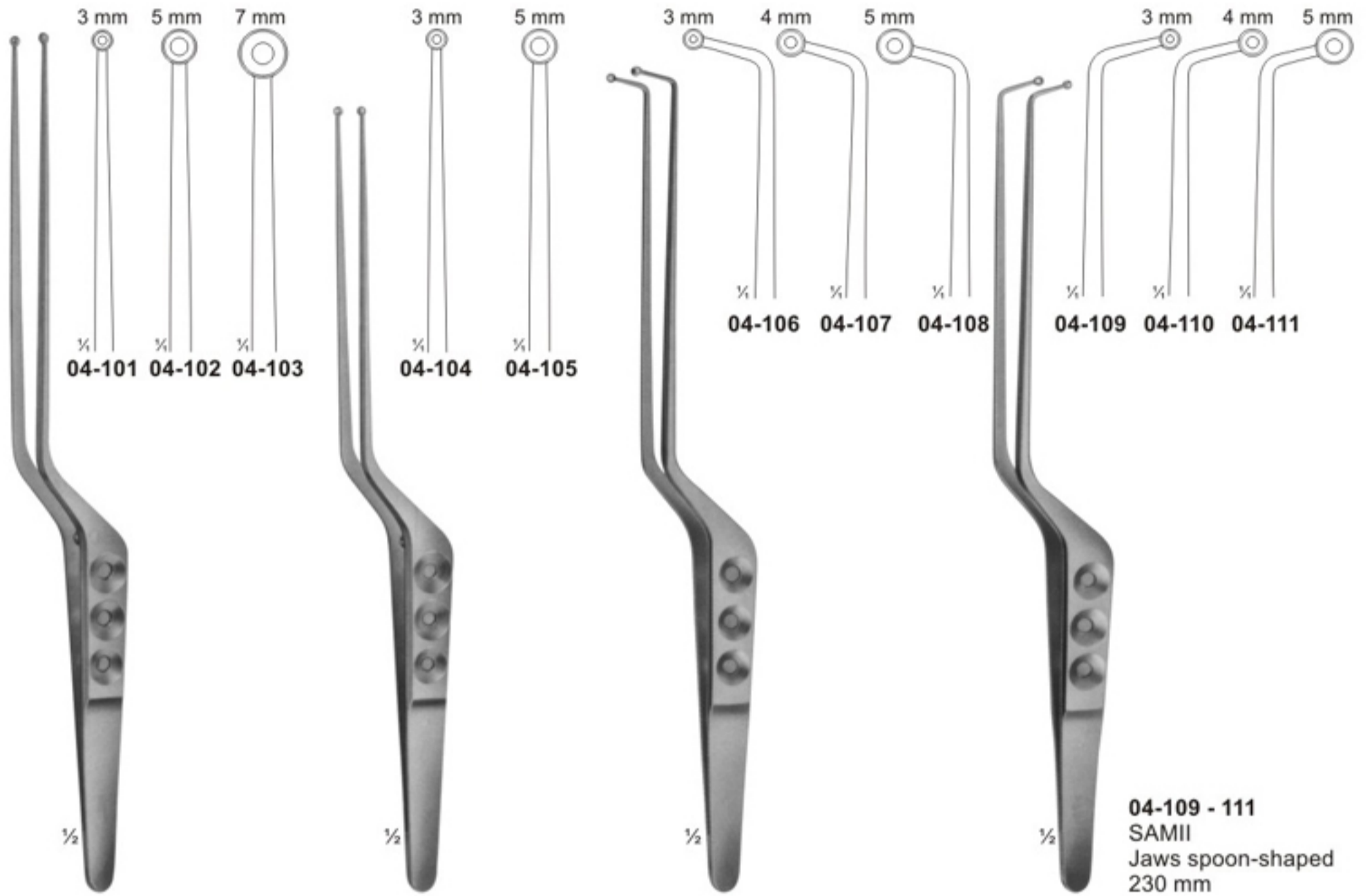

04-101 - 103
YASARGIL-SAMII
Jaws spoon-shaped
240 mm

04-104 - 105
YASARGIL
Jaws spoon-shaped
220 mm

04-106 - 108
SAMII
Jaws spoon-shaped
230 mm

04-112
HUNT
Tumor-and
vessel forceps
200 mm

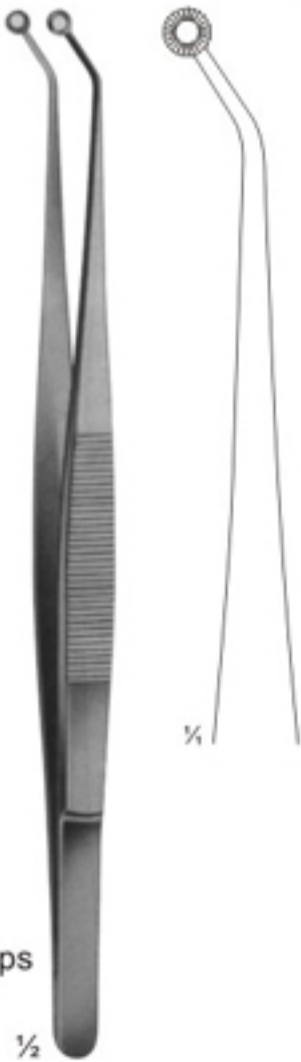

04-113
HUNT
Tumor-and
vessel forceps
200 mm



04-114
YASARGIL
Tumor-and
vessel forceps
200 mm



Delicate Dissecting, Microscopic, Sterilizing Forceps

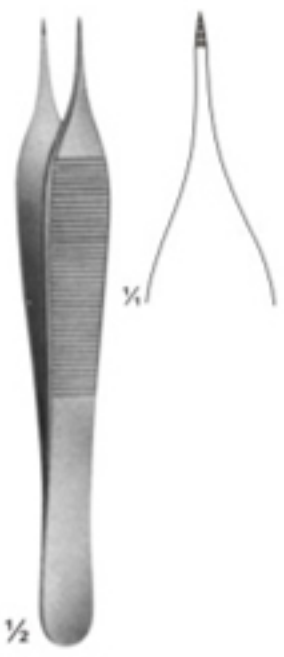

04-115
THORPE
Corneal forceps
120 mm

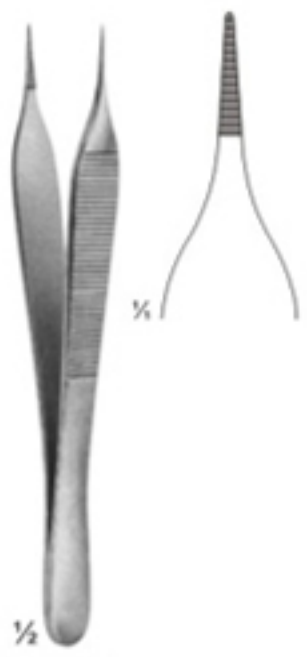

04-116
MICRO-ADSON
120 mm

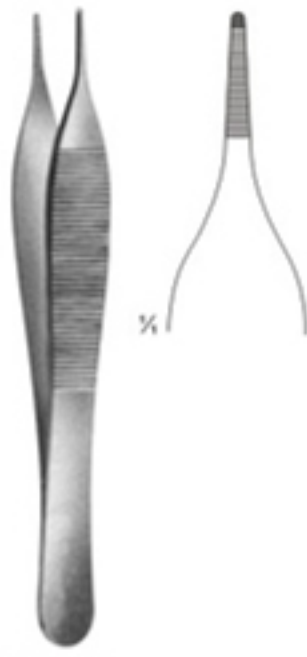

04-117
ADSON
120 mm

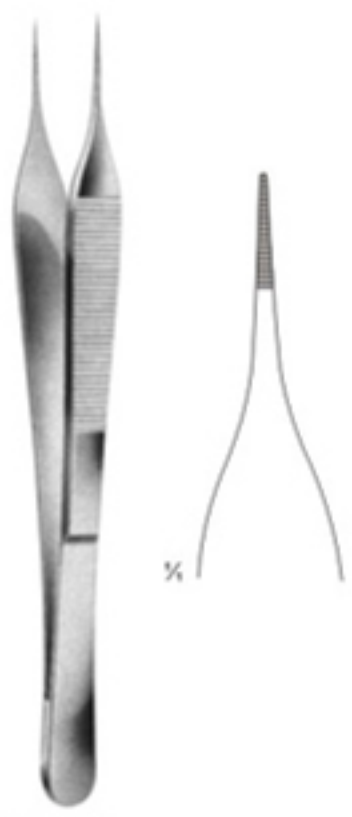

04-118
MICRO-ADSON
150 mm



04-119 - 121
100 mm



04-119



04-120



04-121

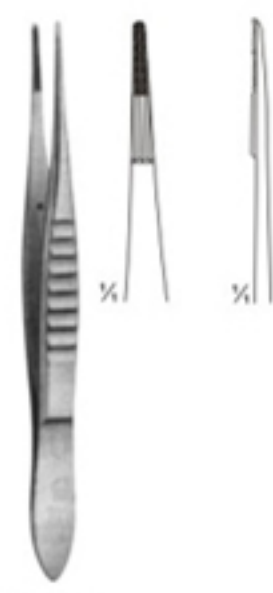

04-122
BONACCOLTO
110 mm

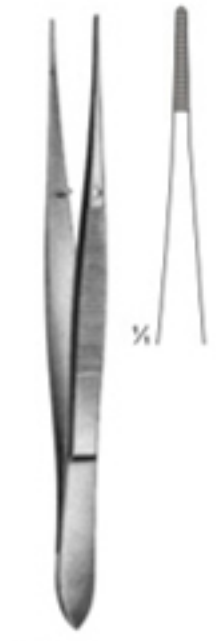

04-123
115 mm



04-124 - 133

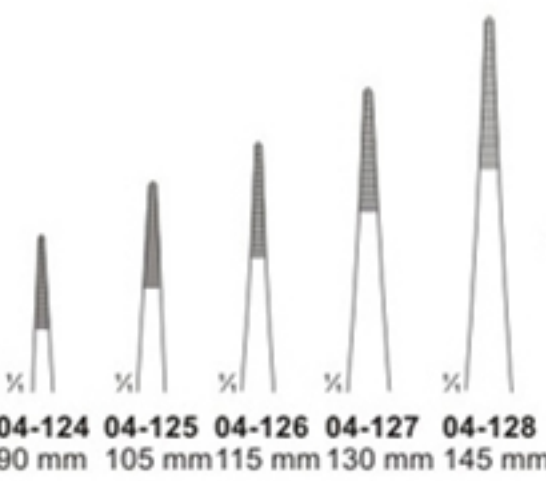

04-124 90 mm **04-125** 105 mm **04-126** 115 mm **04-127** 130 mm **04-128** 145 mm



04-129 90 mm



04-130 105 mm



04-131 115 mm



04-132 130 mm



04-133 145 mm



04-134
100 mm

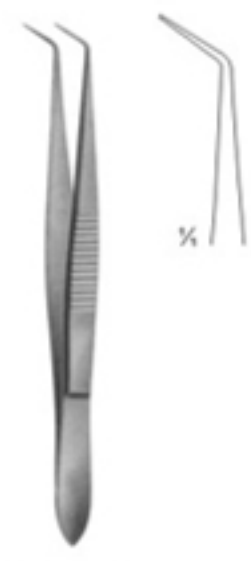

04-135
100 mm



04-136
100 mm

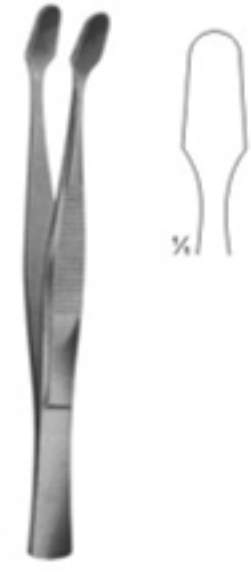

04-137
KUHNE
Cover glass forceps, 105 mm



04-138
160 mm

Delicate Dissecting Forceps

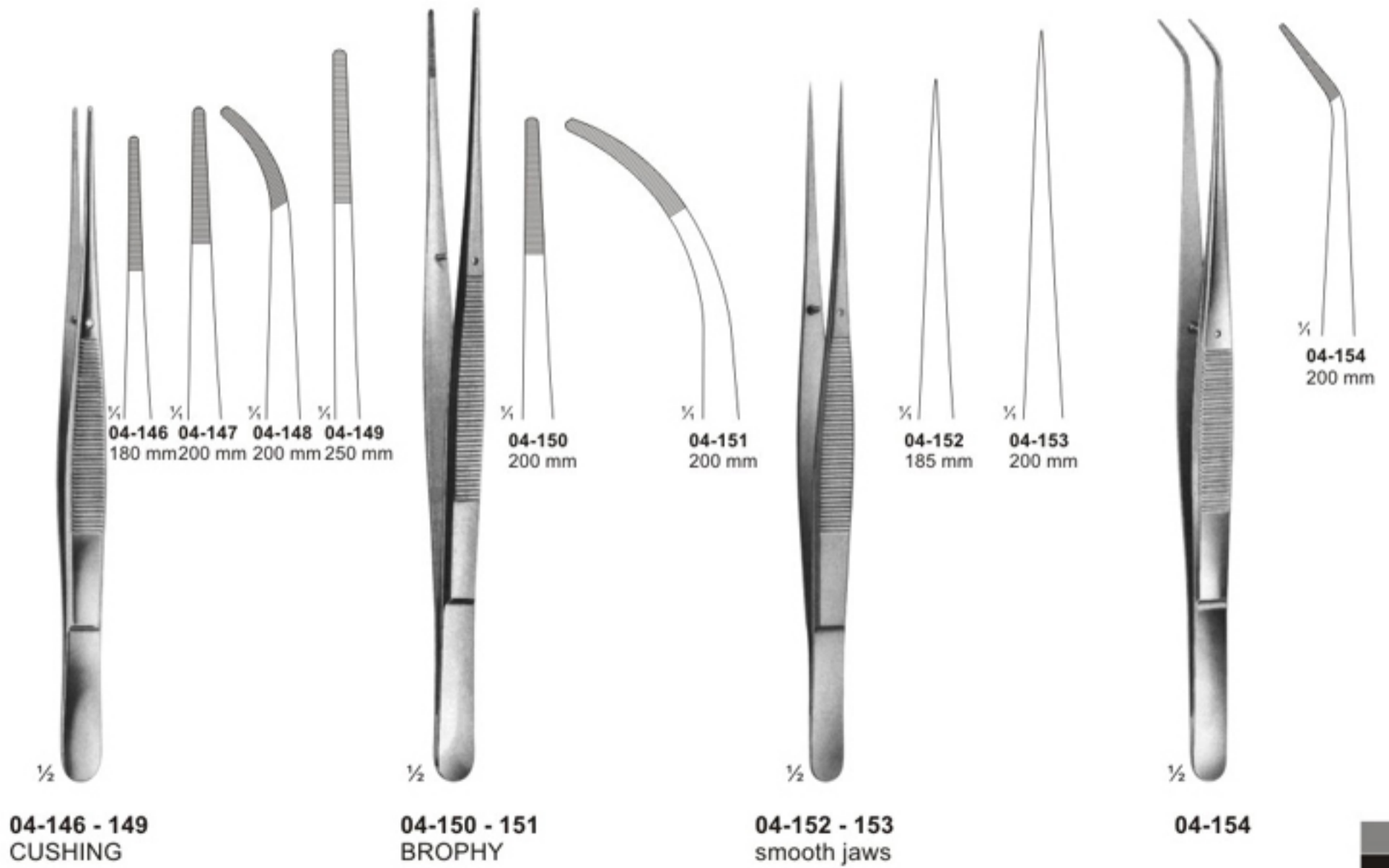
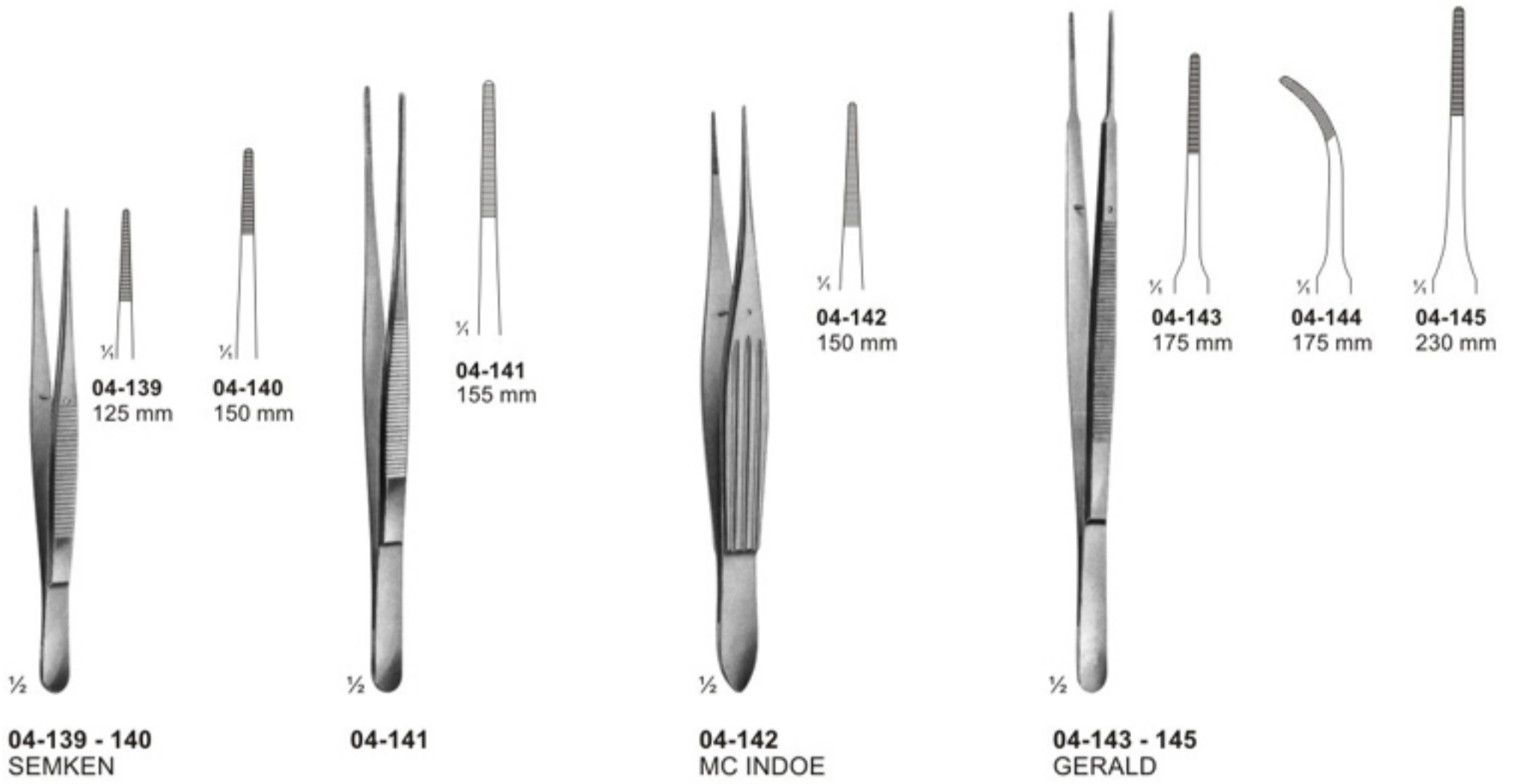

Dissecting Forceps

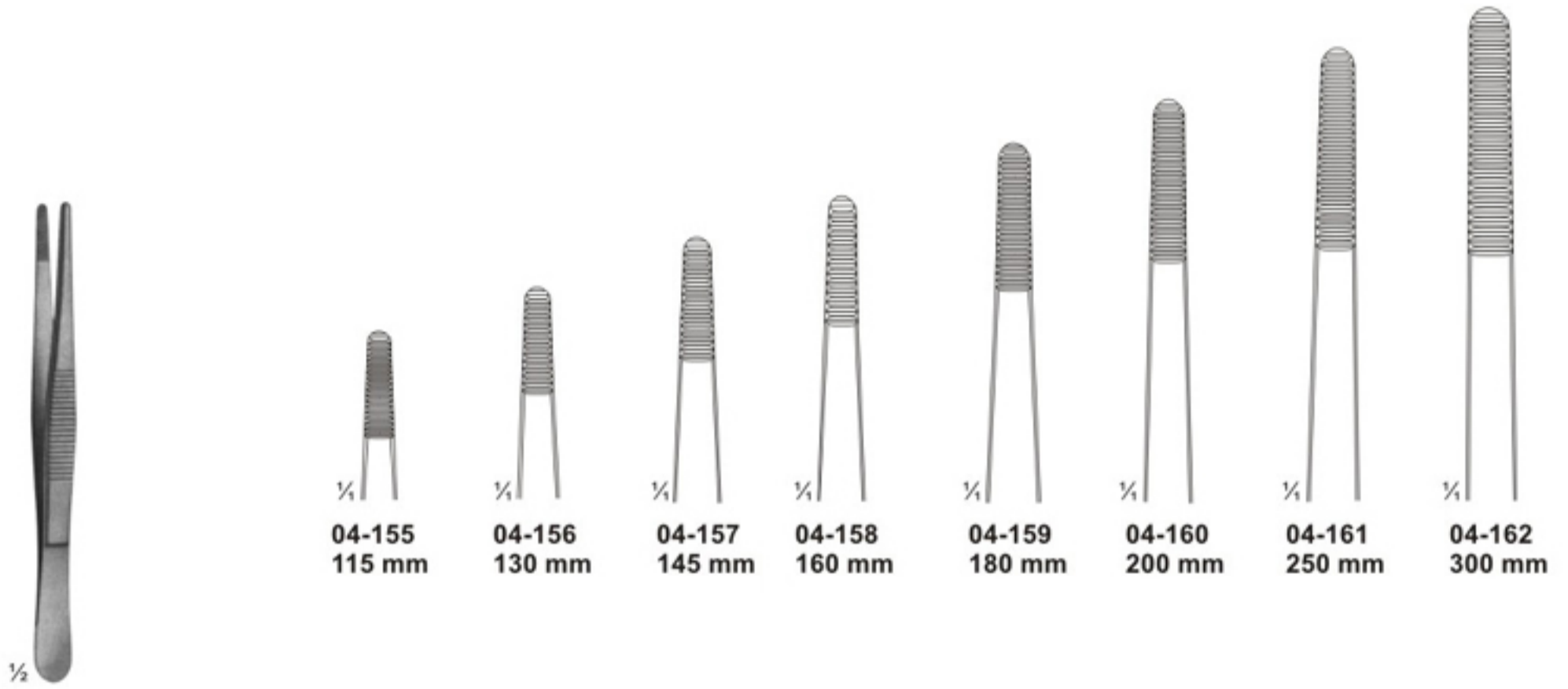

04-155 - 04-162
STANDARD

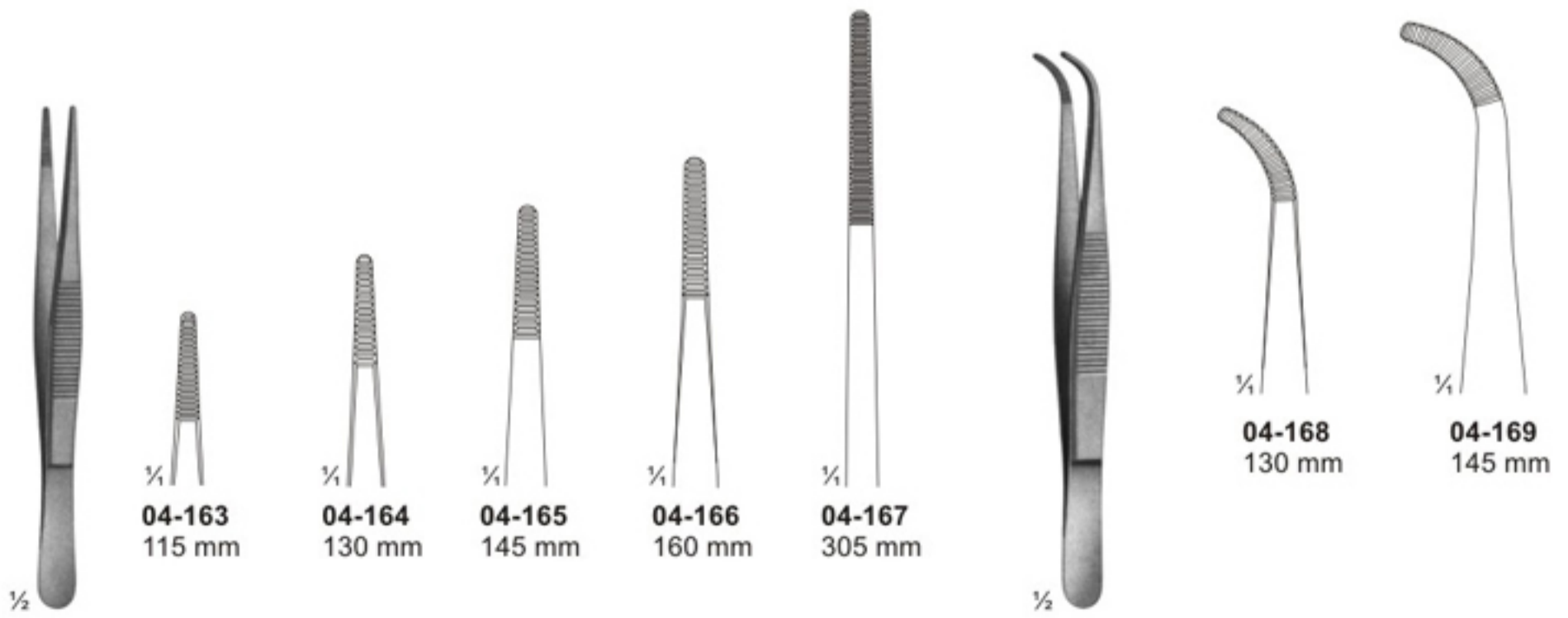

04-163 - 04-167
MEDIUM

04-168 - 04-169
MEDIUM

Forceps

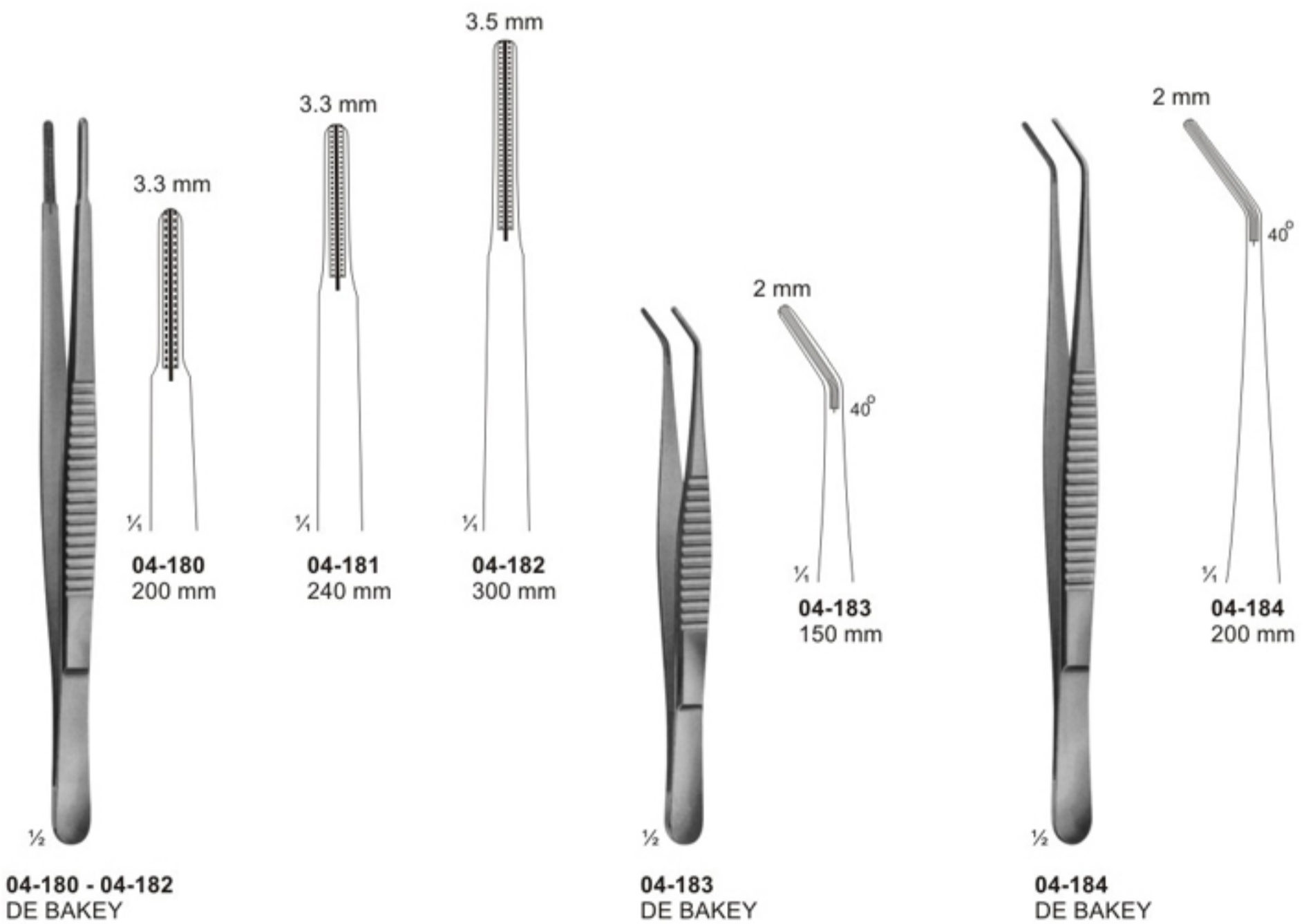
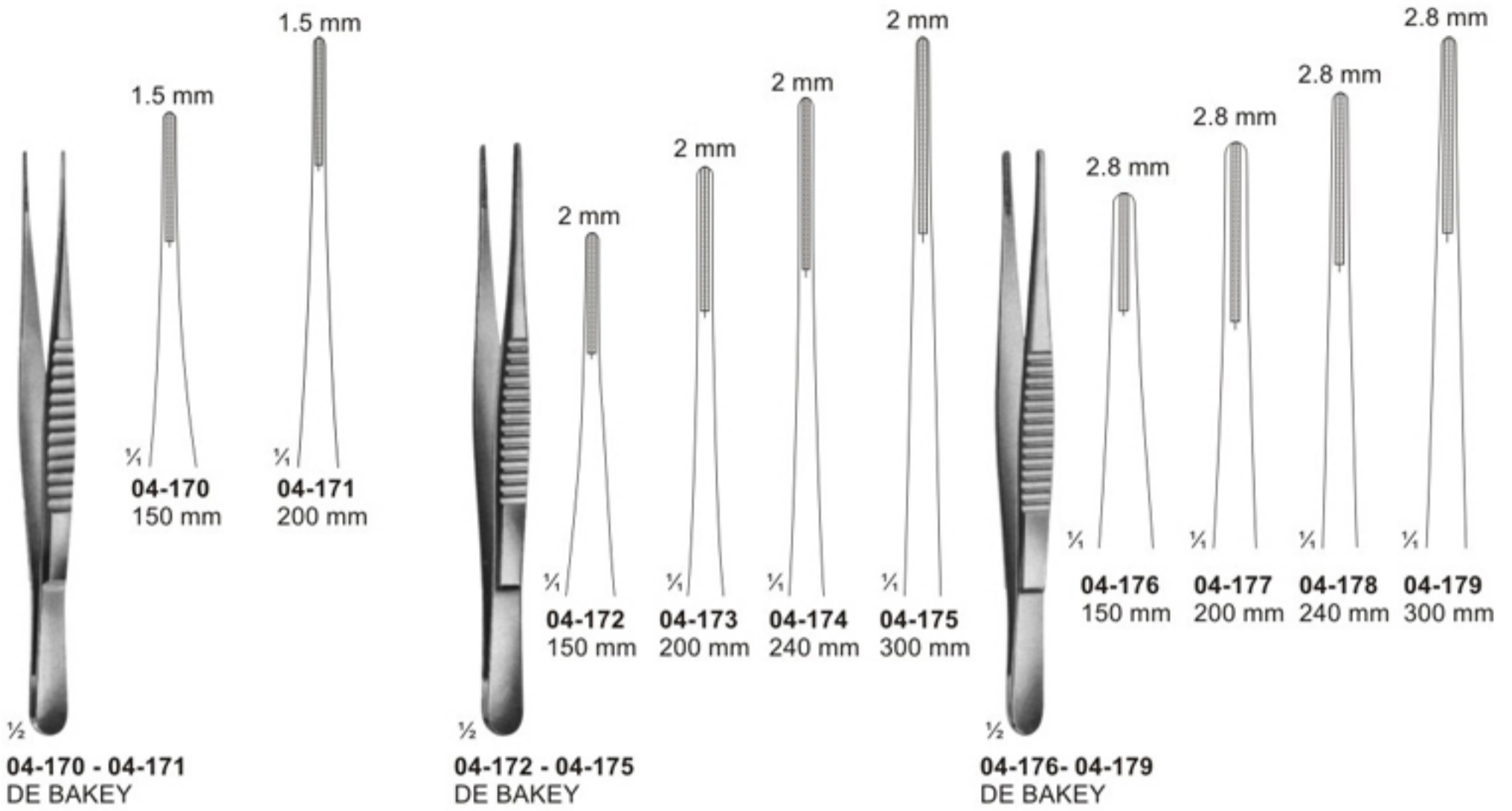

Delicate Tissue Forceps

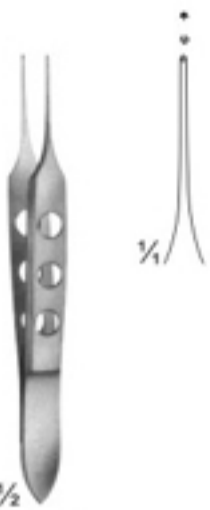

04-185
BISHOP-HARMON
 85 mm

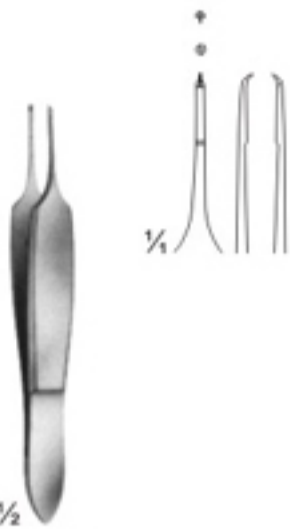

04-186
ST. MARTIN
 80 mm

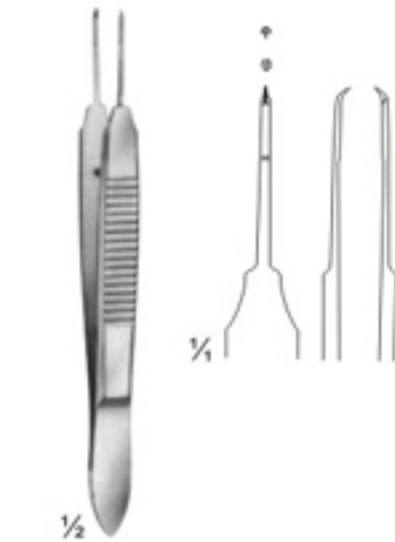

04-187
CASTROVIEJO
 teeth 0.9 mm
 100 mm

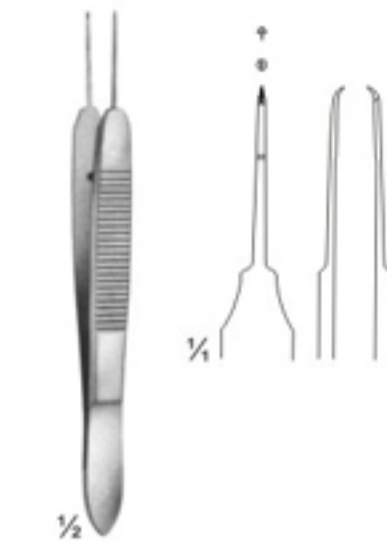

04-188
CASTROVIEJO
 teeth 0.5 mm
 100 mm

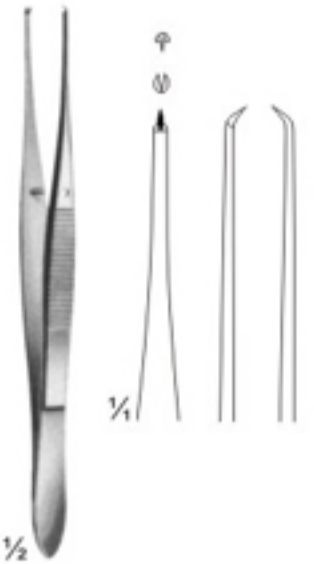

04-189
ELSCHING
 110 mm



04-190
GILL
 75 mm



04-191
GILL - HESS
 75 mm

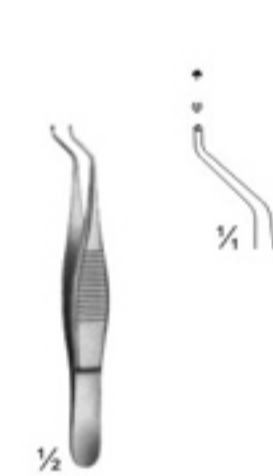

04-192
HESS
 70 mm

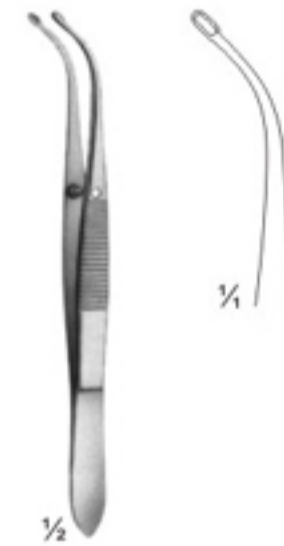

04-193
ARRUGA
 100 mm

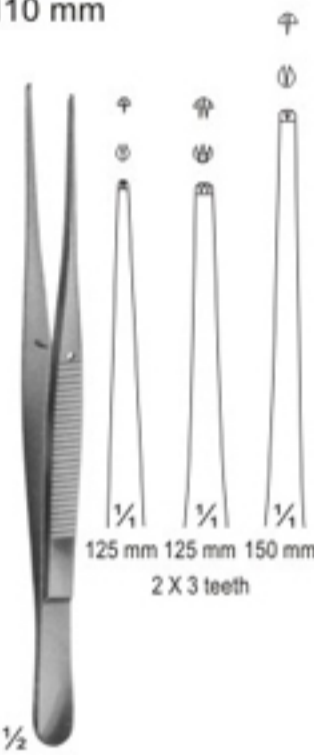

04-194
SEMKEN

125 mm 125 mm 150 mm
 2 X 3 teeth



04-195
MICRO-ADSON
 120 mm

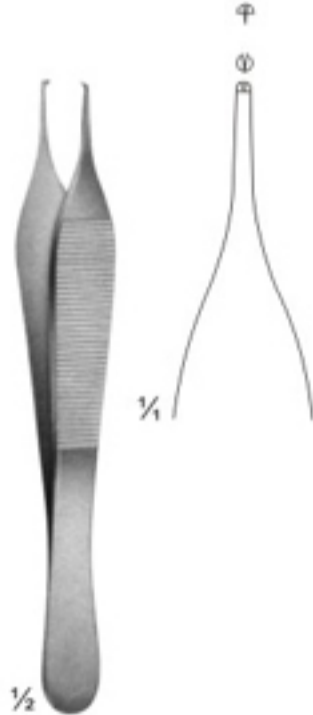

04-196
ADSON
 120 mm



04-197
ADSON
 120 mm



04-198
ADSON
 120 mm



04-199
ADSON
 150 mm

Tissue Forceps

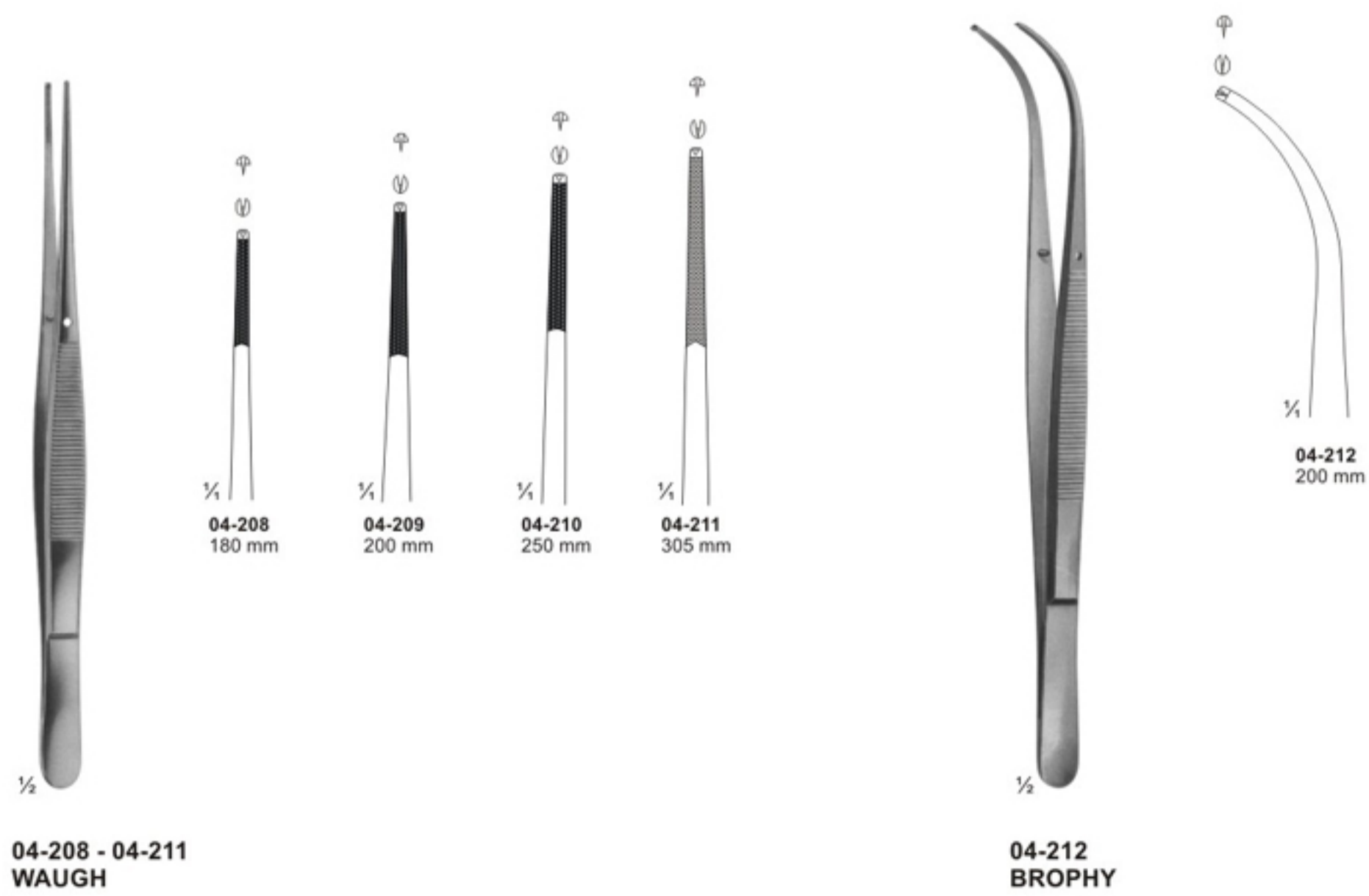
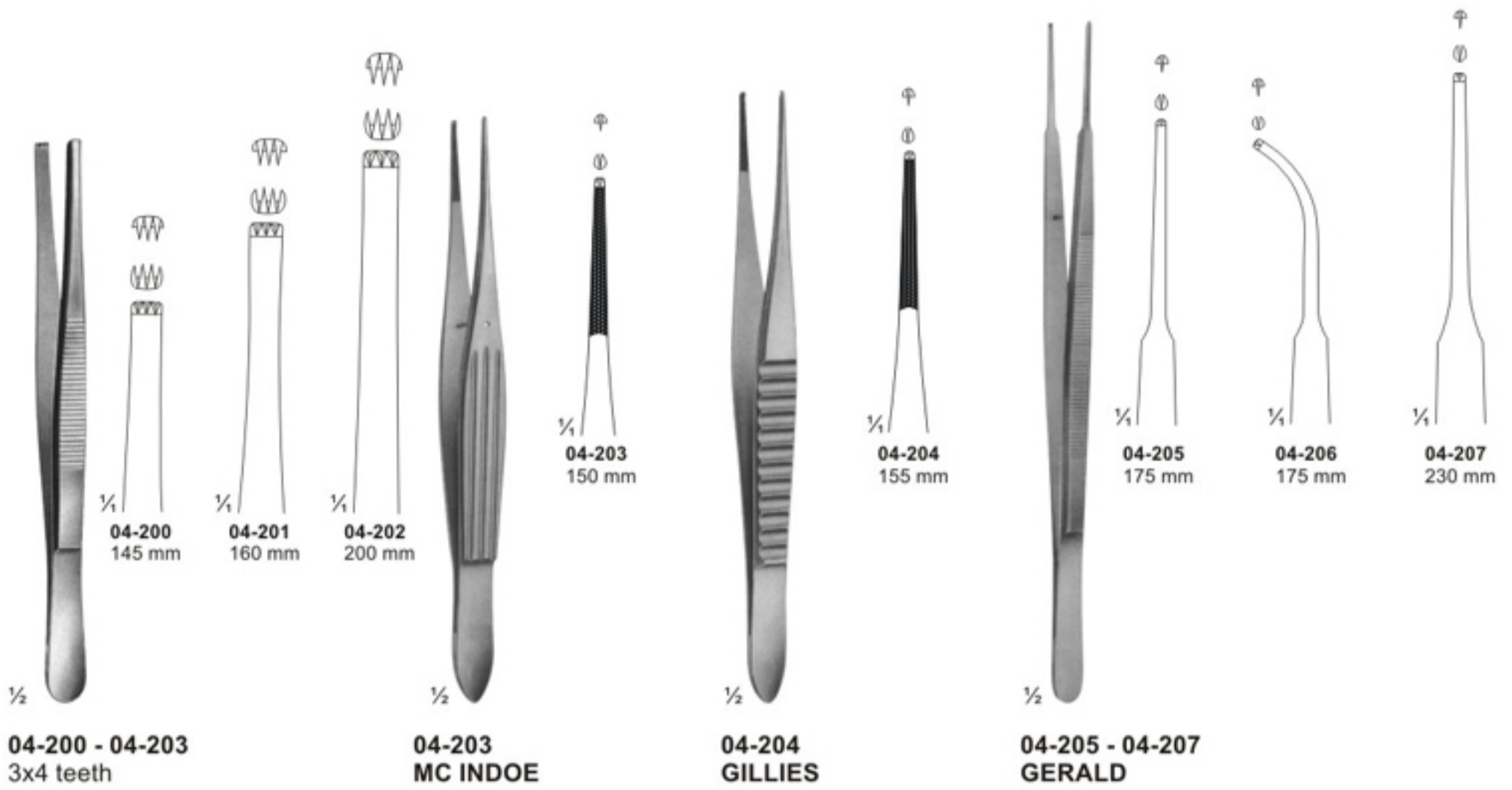

Tissue Forceps

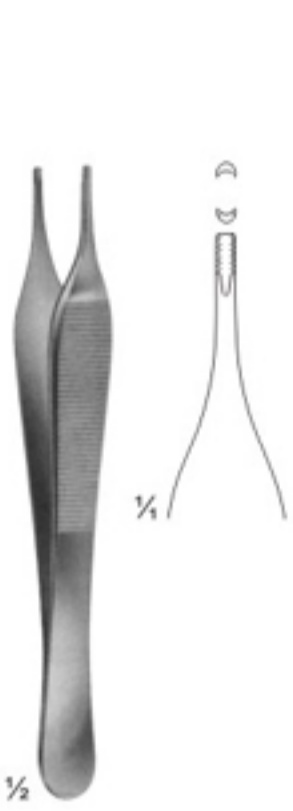

04-213
ADSON - BROWN
 Non-traumatic
 120 mm

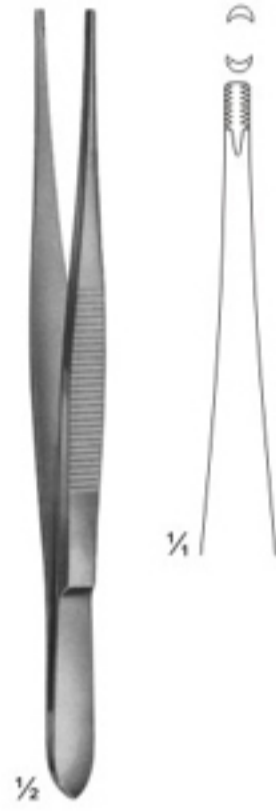

04-214
BROWN
 120 mm



04-215
GRAEFE
 110 mm

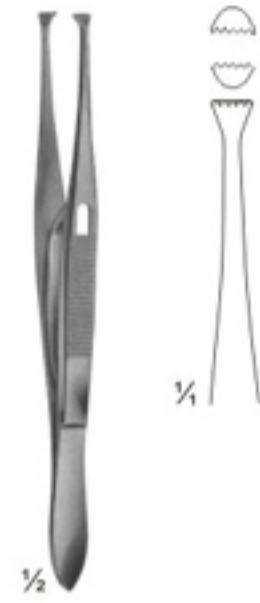

04-216
GRAEFE
 With Catch
 110 mm

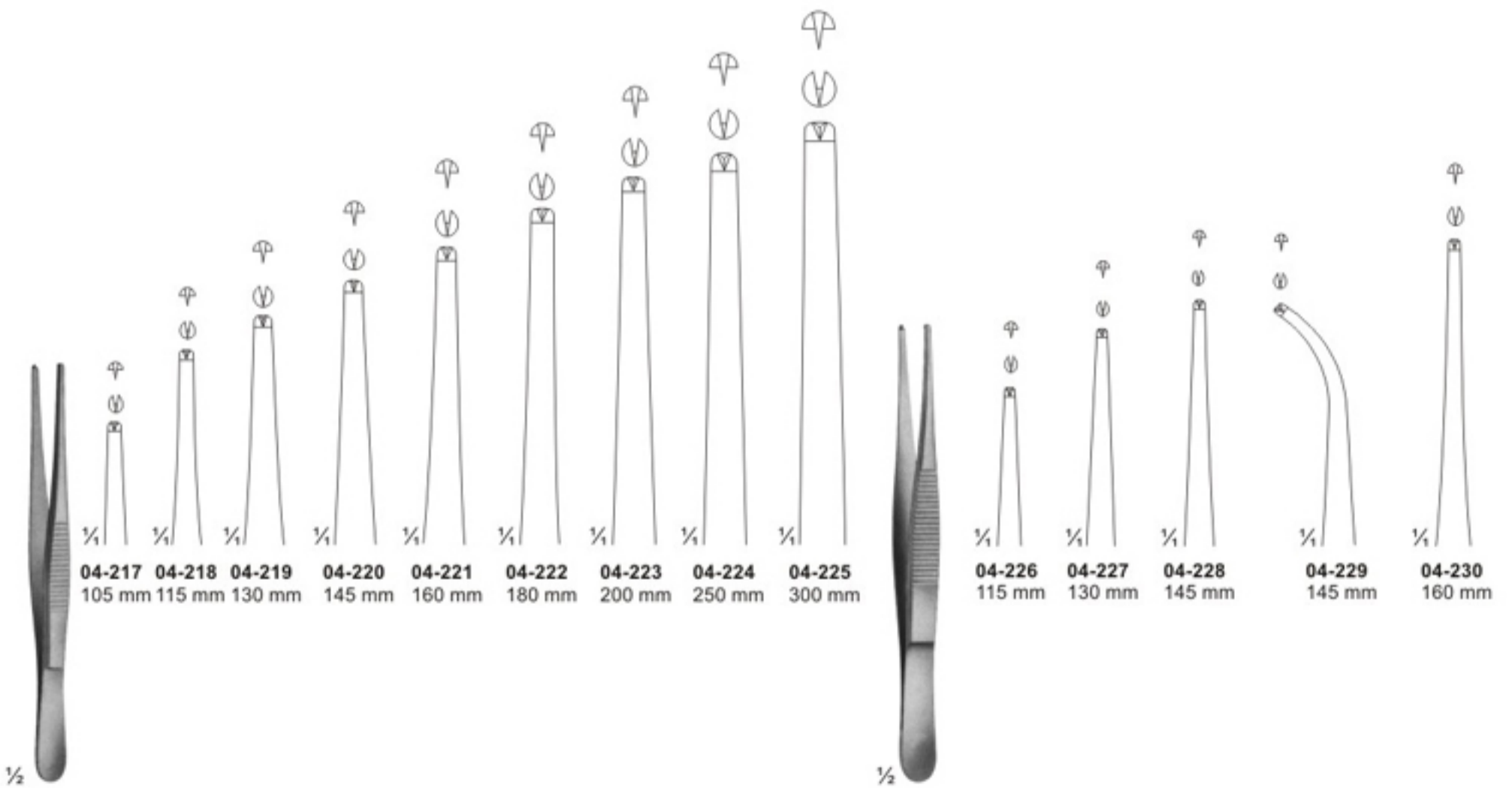

04-217 - 04-225
STANDARD

04-226 - 04-230
GRAEFE
 110 mm

Forceps, Bayonet - Shaped

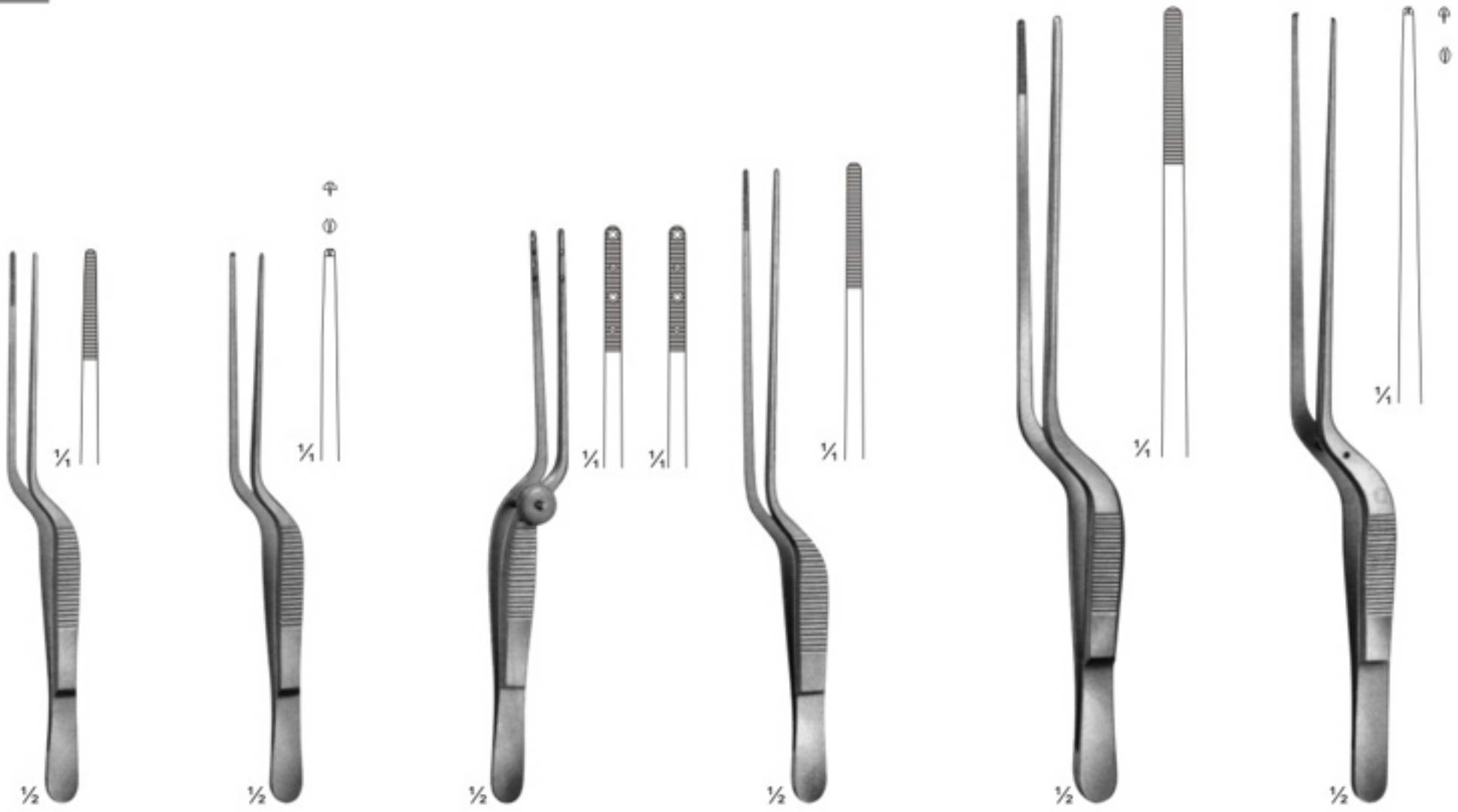

04-231
 LUCAE
 140 mm

04-232
 LUCAE
 1x2 teeth
 140 mm

04-233
 COTTLE
 Forceps with
 jaws toothed
 and serrated
 140 mm

04-234
 JANSEN
 160 mm

04-235
 GRUENWALD
 200 mm

04-236
 1x2 teeth
 200 mm

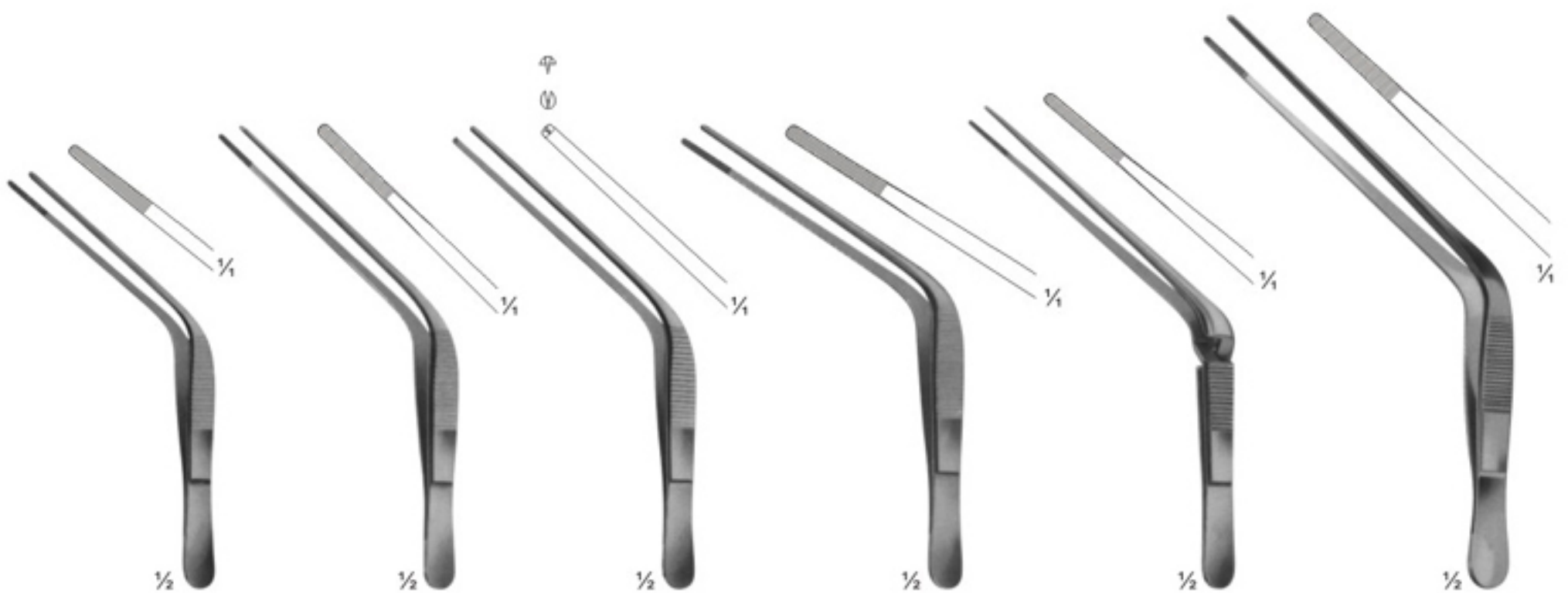

04-237
 TROELTSCH
 100 mm

04-238
 TROELTSCH
 115 mm

04-239
 TROELTSCH
 1X2 teeth
 115 mm

04-240
 WILDE
 115 mm

04-241
 TROELTSCH
 Cross action
 120 mm

04-242
 TROELTSCH
 140 mm

Tissue Forceps, Lung Dissecting Forceps

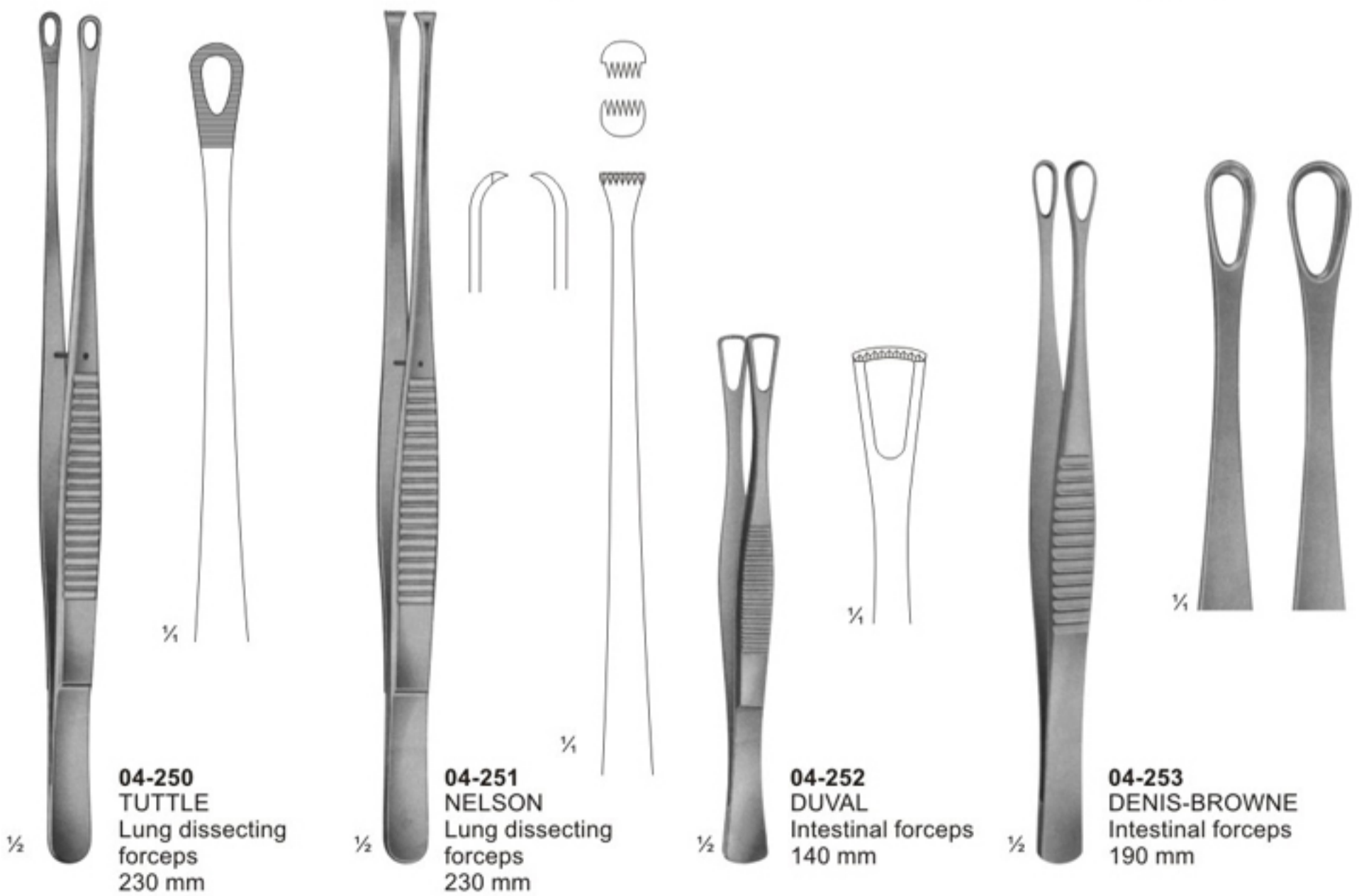
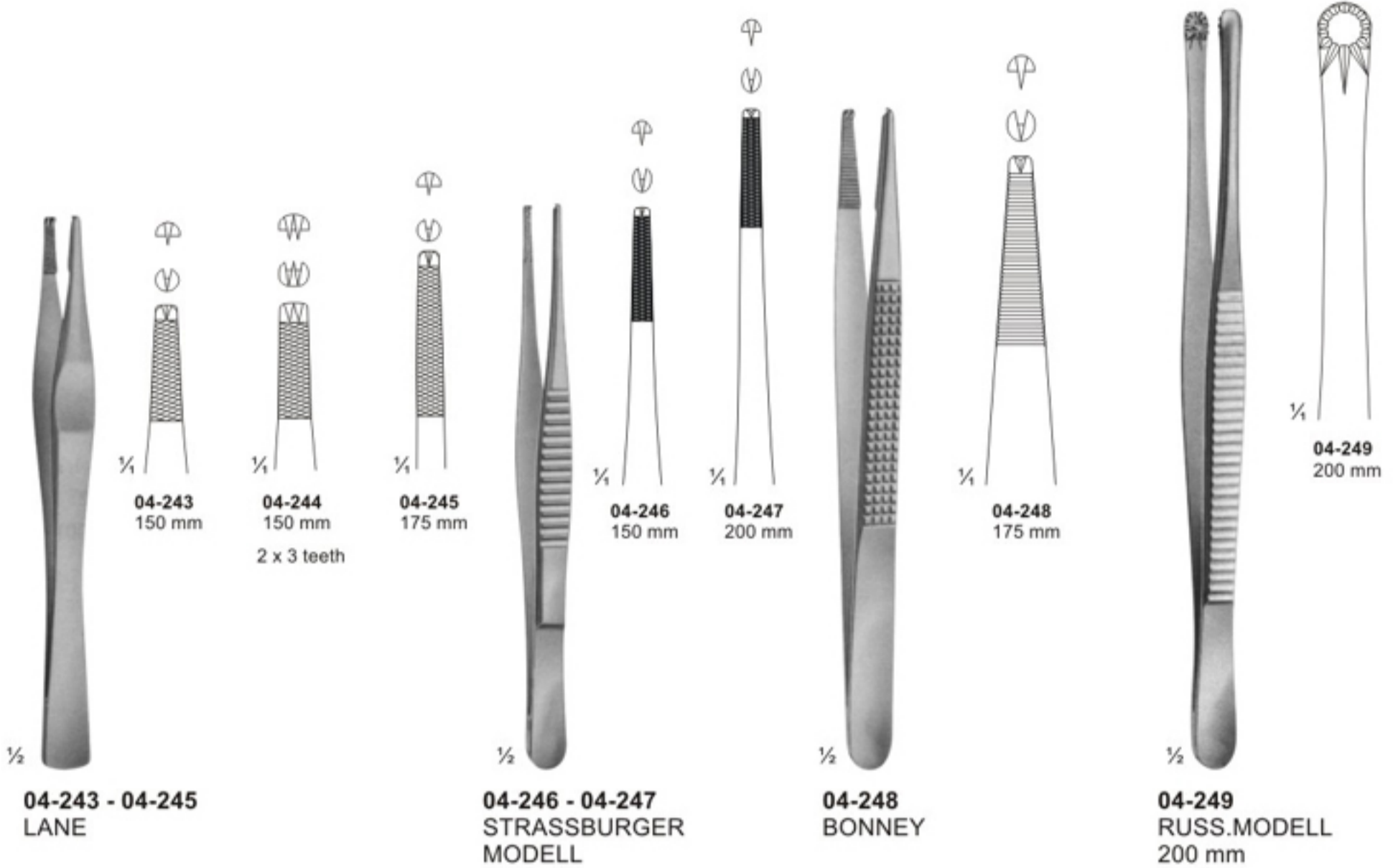

Splinter and Cilia Forceps

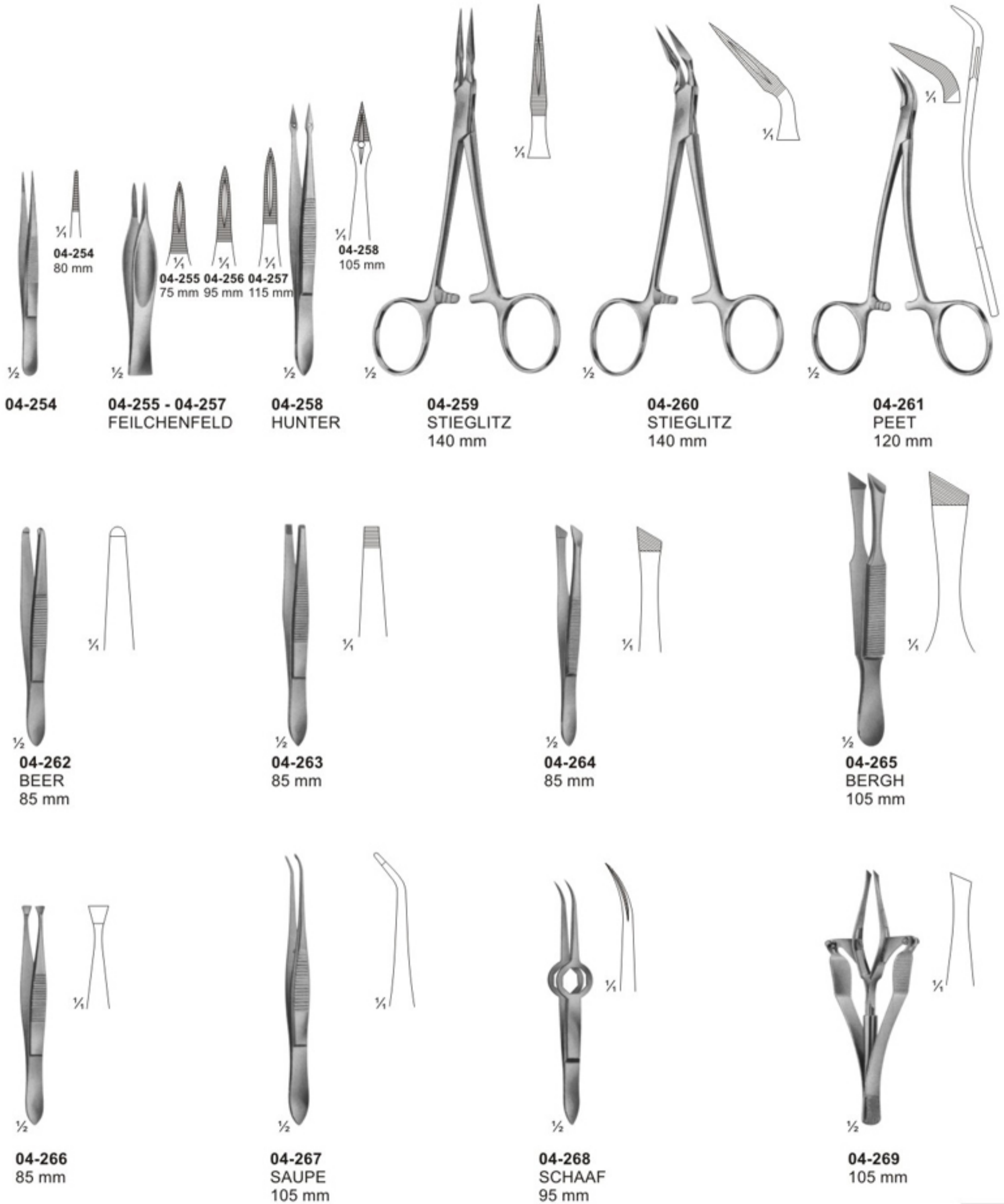

Sponge and Dressing Forceps



04-270
BRYANT
 130 mm

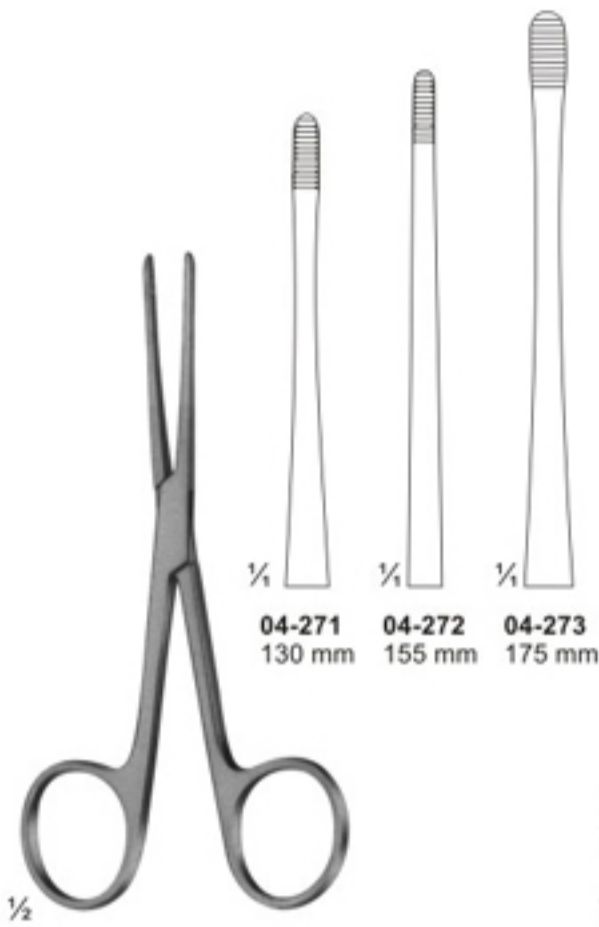

04-271 - 04-273
LISTER
 Sinus forceps

04-271 130 mm
04-272 155 mm
04-273 175 mm

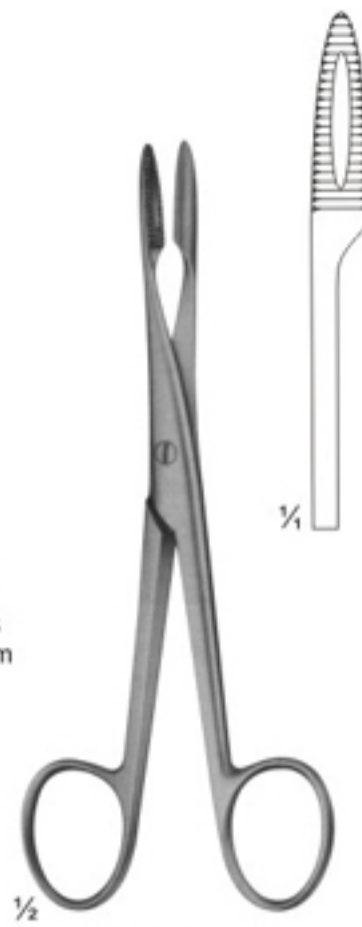

04-274
 without ratchet
 145 mm

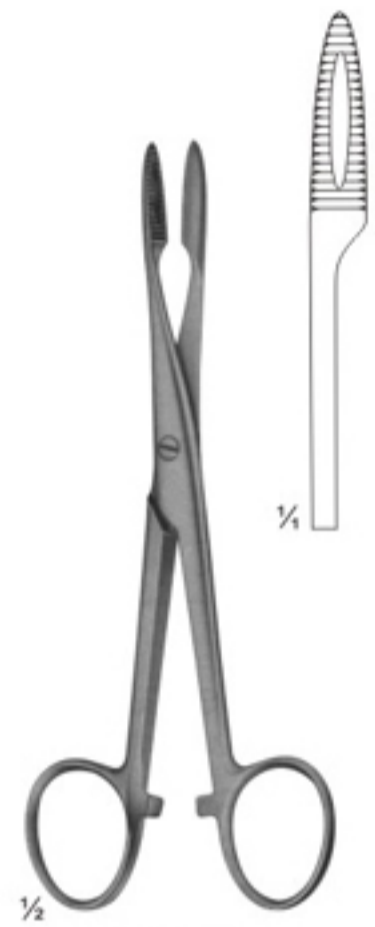

04-275
 with ratchet
 145 mm

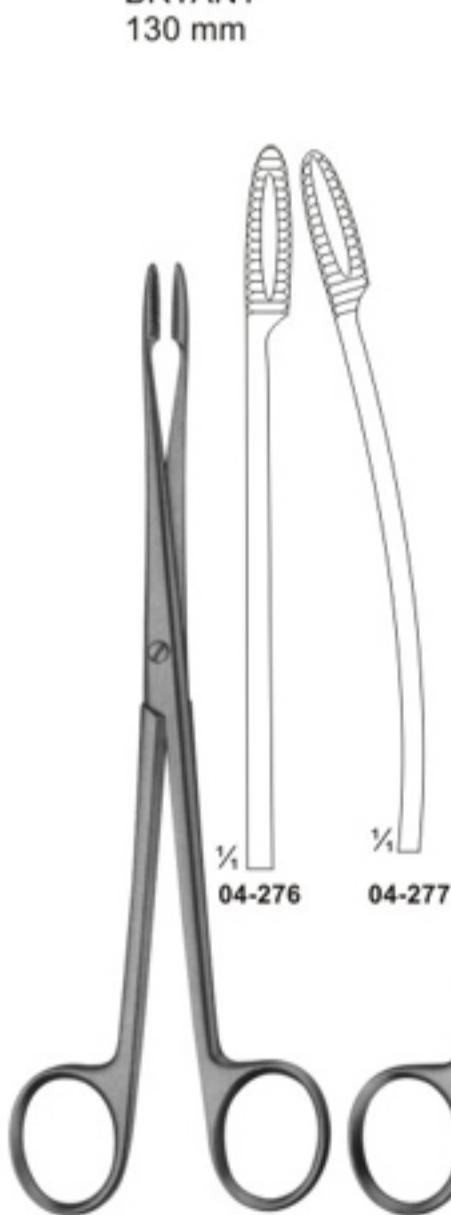

04-276 - 04-277
GROSS
 without ratchet
 180 mm

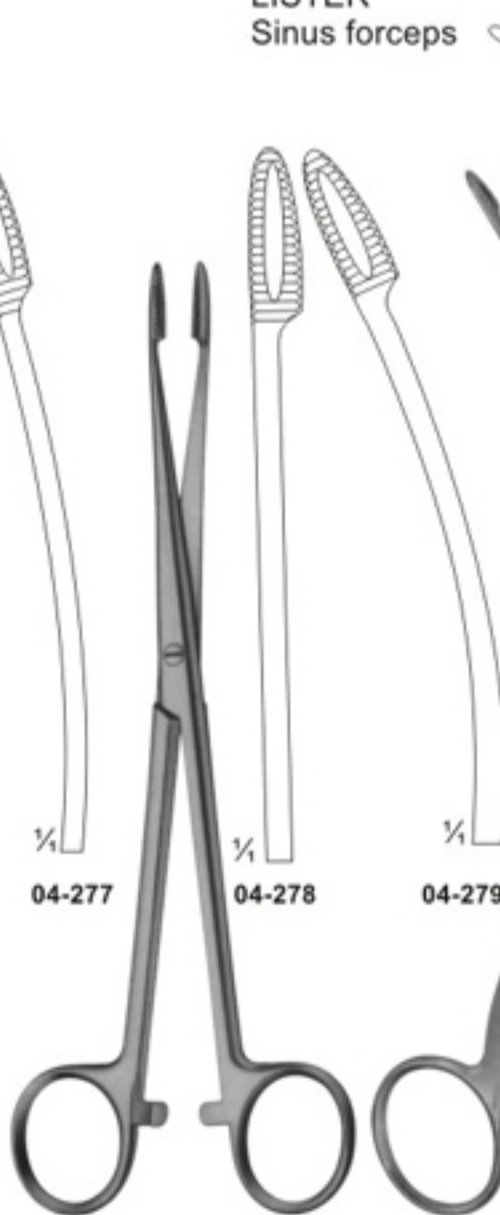

04-278 - 04-279
GROSS
 with ratchet
 180 mm

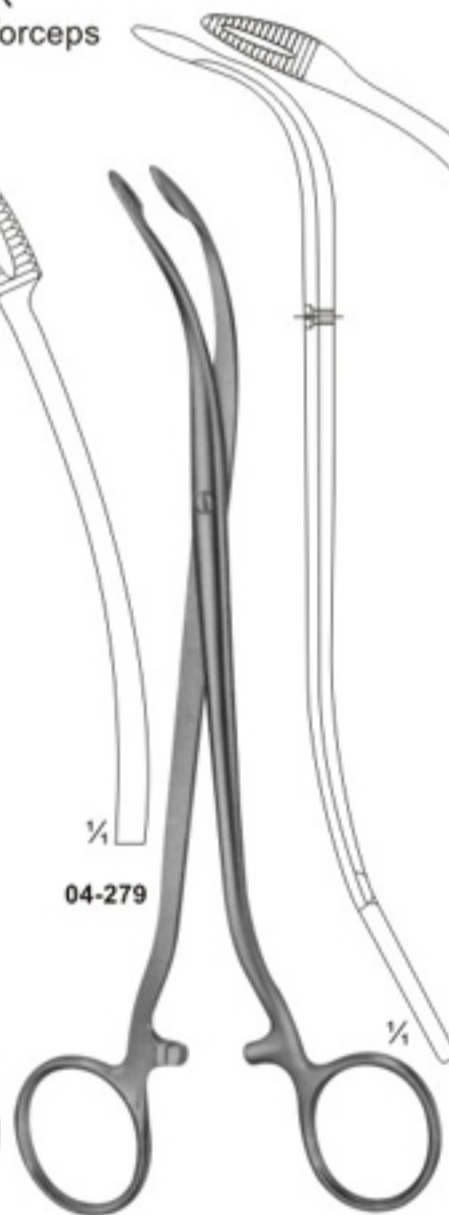

04-280
DUPLAY
 190 mm

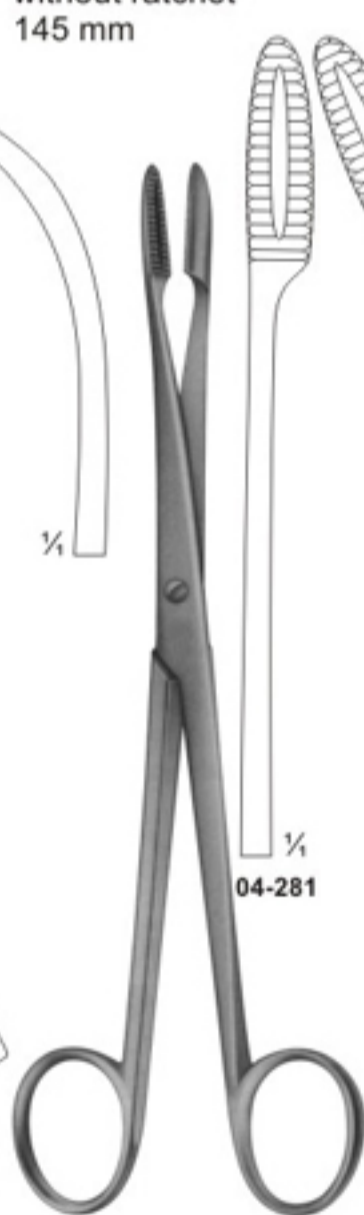

04-281 - 04-282
GROSS
 without ratchet
 200 mm

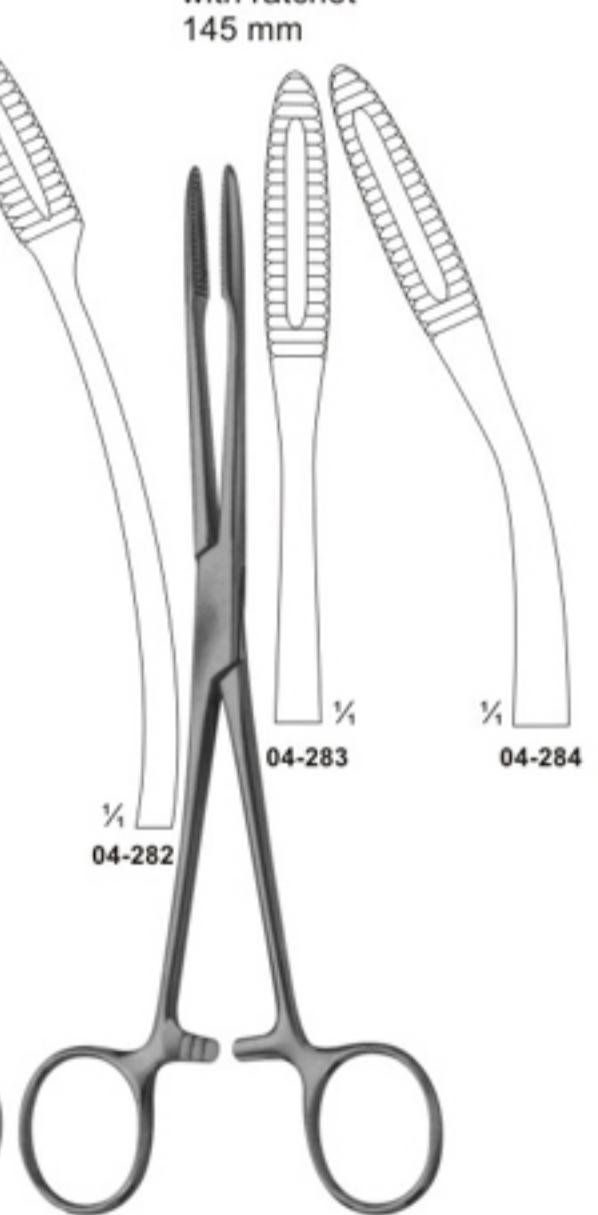

04-283 - 04-284
GROSS
 200 mm

Dressing-, Sponge holding-, Organ- and Tissue Grasping Forceps

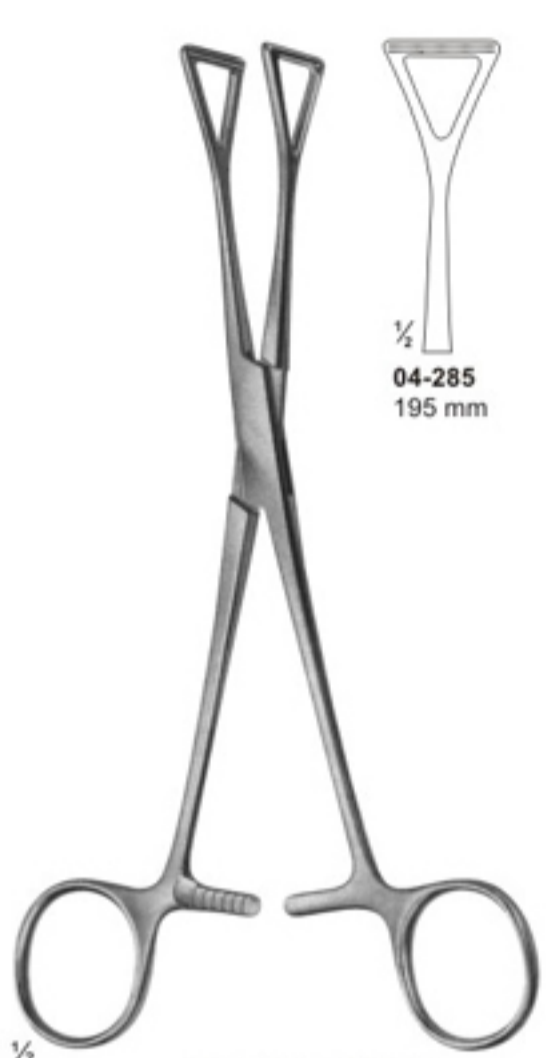

04-285 - 04-286
COLLIN

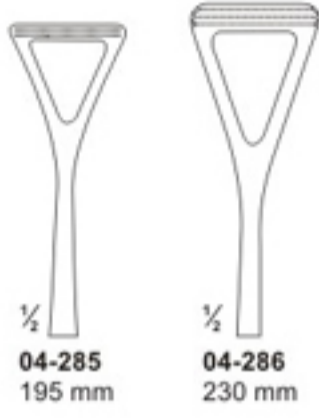

04-285
195 mm

04-286
230 mm

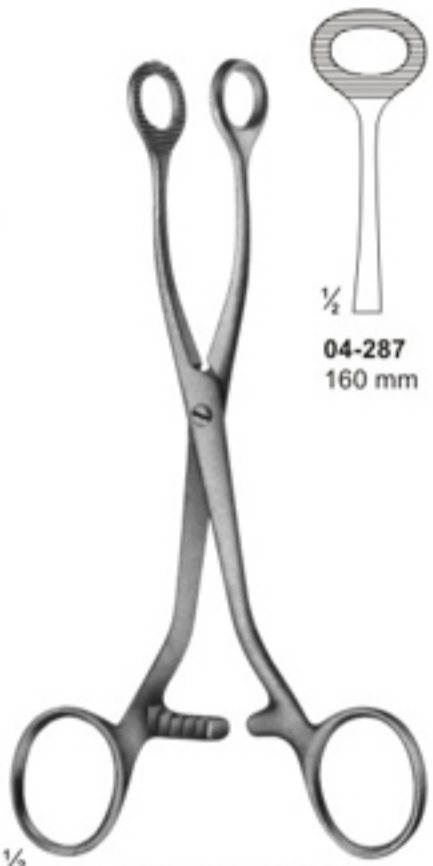

04-287 - 04-289
COLLIN



04-287
160 mm



04-288
160 mm



04-289
170 mm

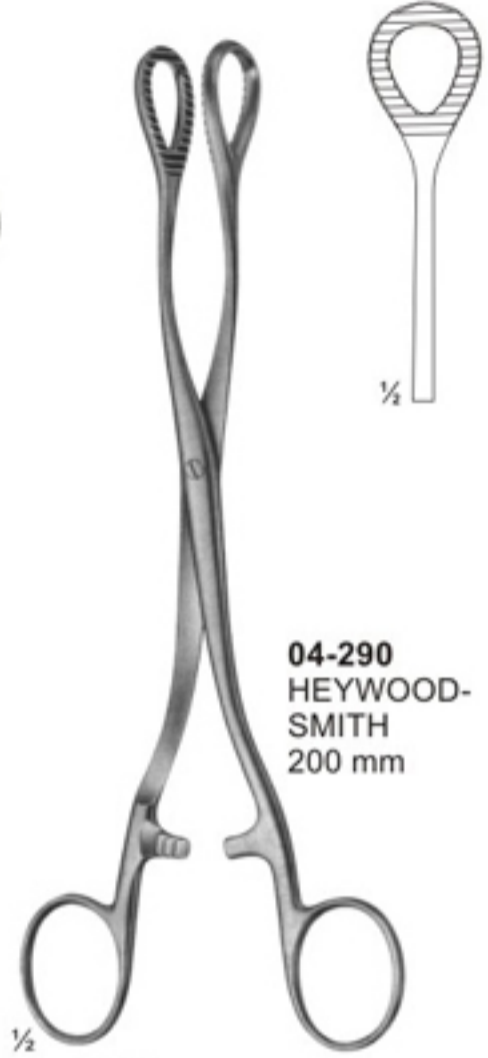

04-290
HEYWOOD-SMITH
200 mm

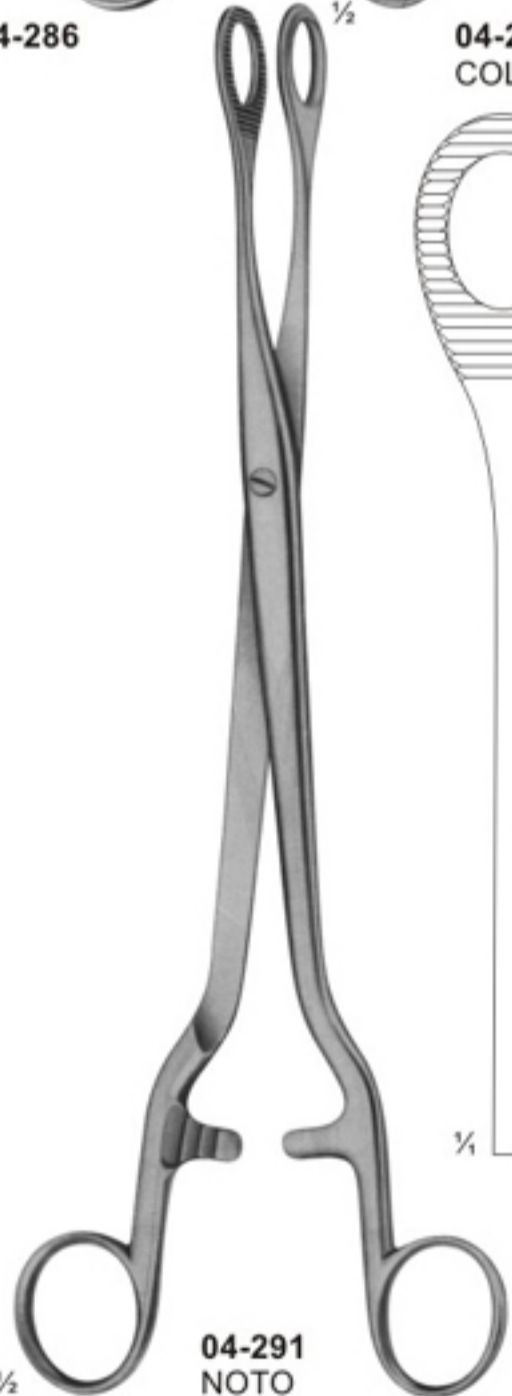

04-291
NOTO
280 mm

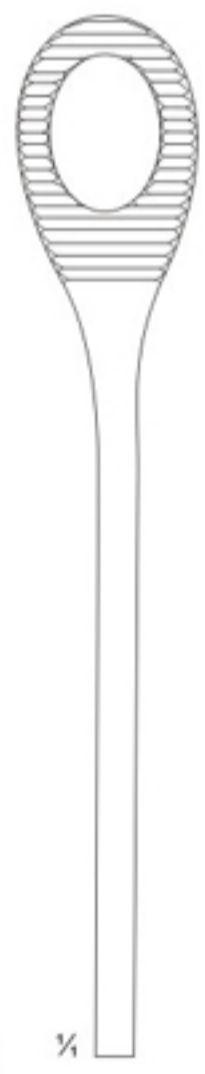

1/2

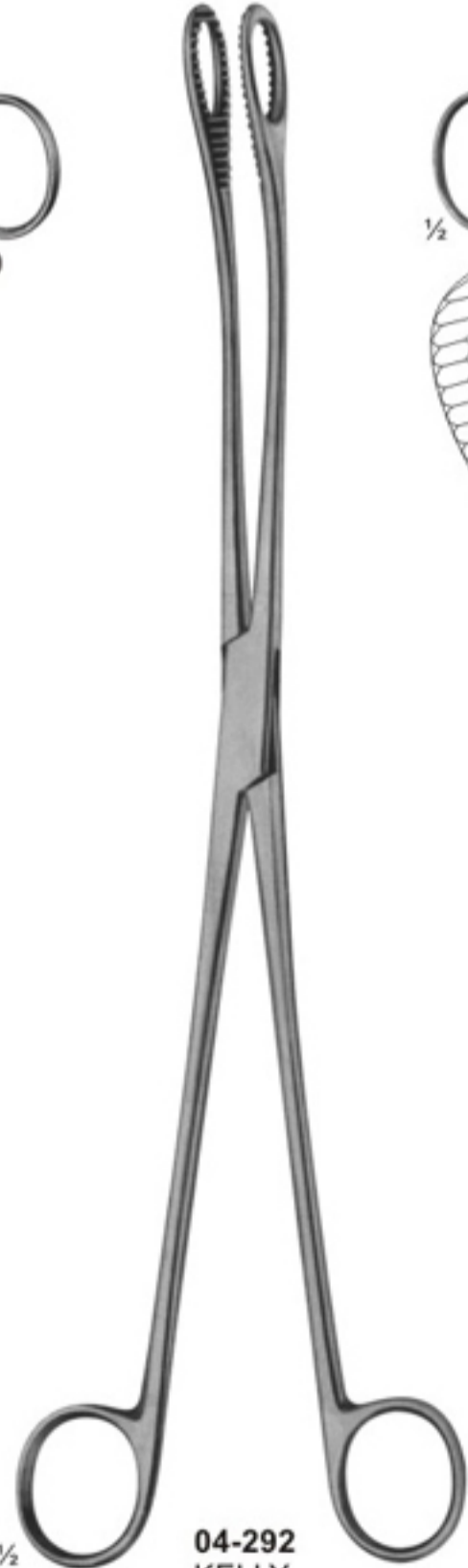

04-292
KELLY
320 mm



1/2

**Dressing, Sponge holding, Organ
and Tissue Grasping Forceps**

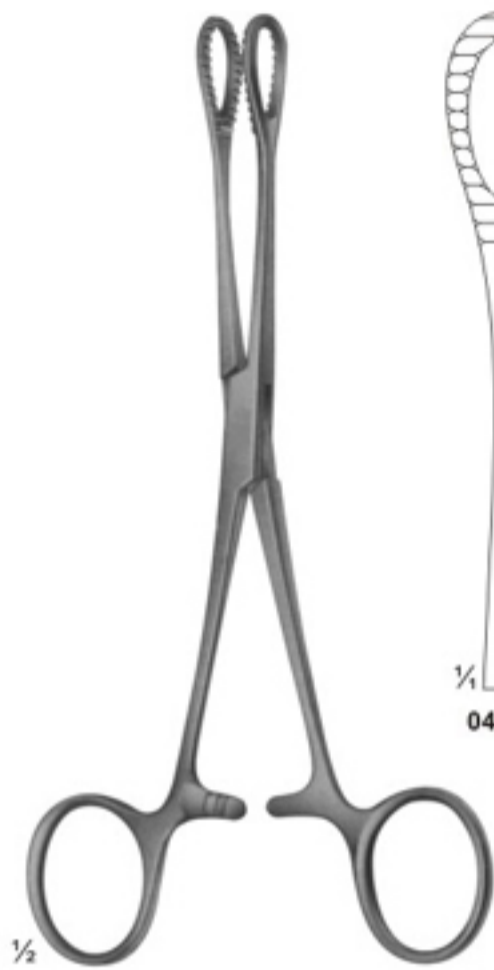

04-293 - 04-294
FOERSTER-BALLENGER
180 mm



$\frac{1}{4}$
04-293



$\frac{1}{4}$
04-294



04-295 - 04-296
RAMPLEY



$\frac{1}{4}$
04-295
180 mm



$\frac{1}{4}$
04-296
250 mm



04-297 - 04-300
FOERSTER-BALLENGER
240 mm



04-297
Smooth Jaws



04-298
Smooth Jaws

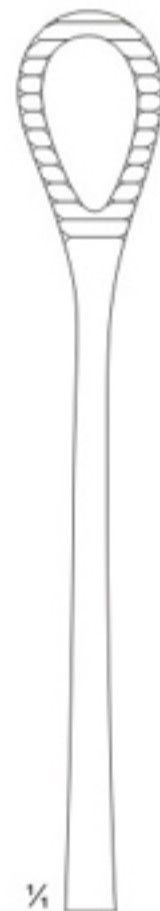

04-299
Serrated Jaws



04-300
Serrated Jaws

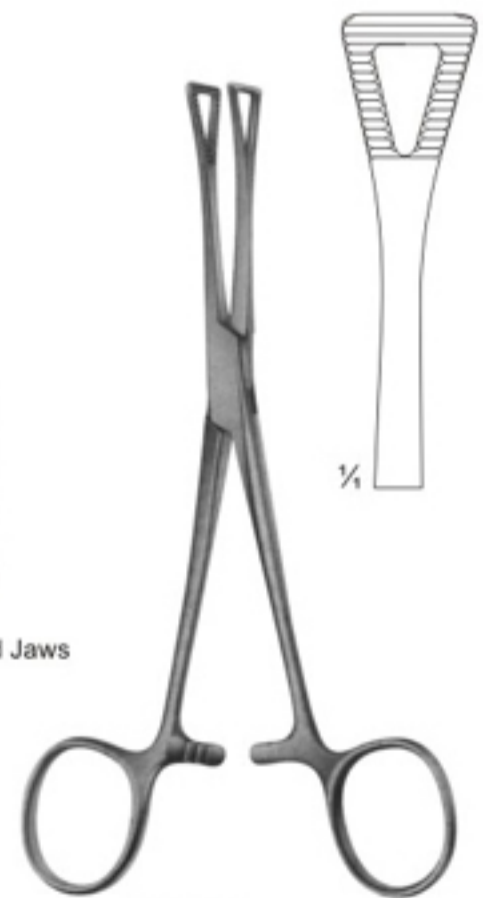

04-301
PENNINGTON
155 mm



$\frac{1}{4}$

Intestinal Grasping Forceps

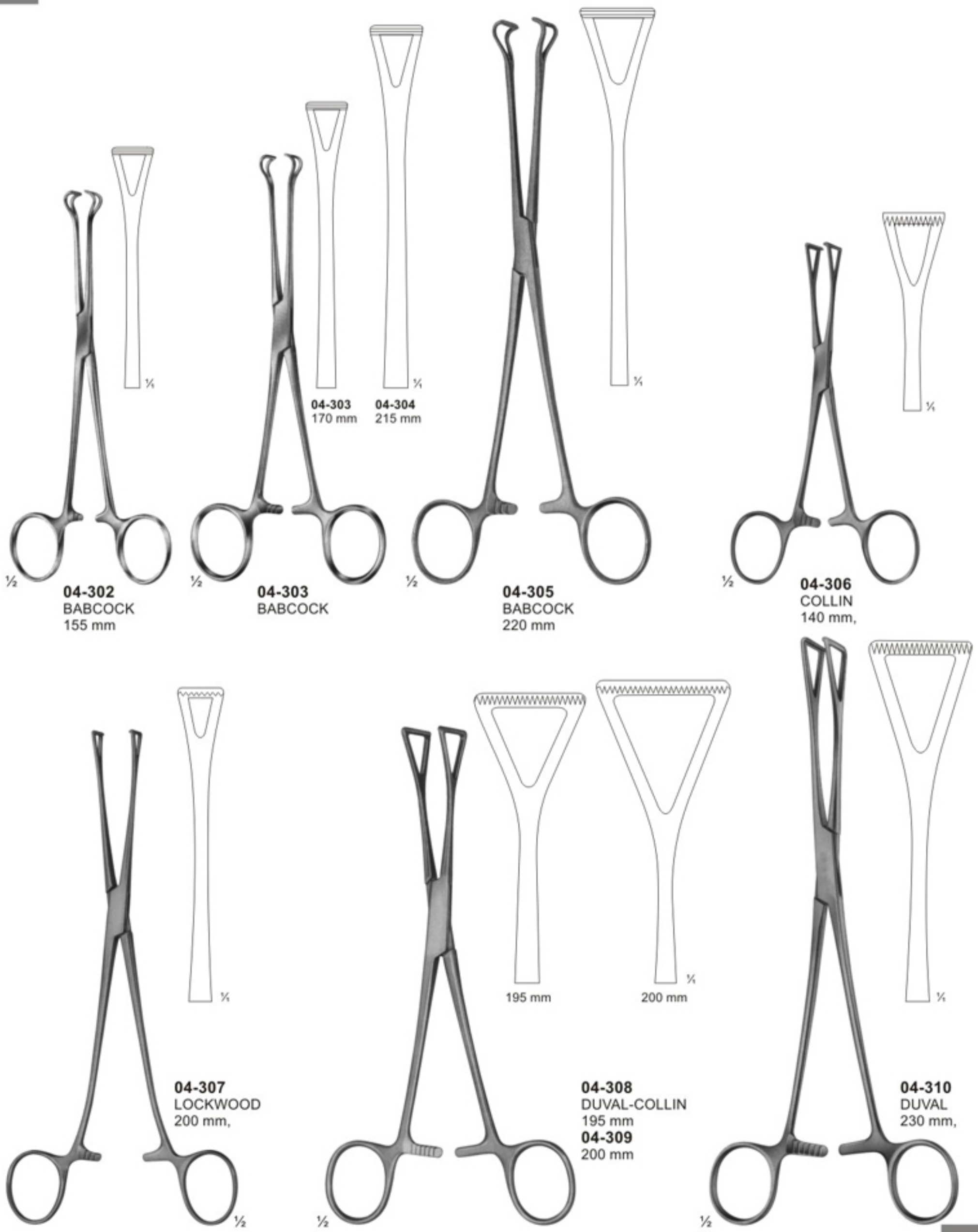

Artery Traction - and Tissue Grasping Forceps

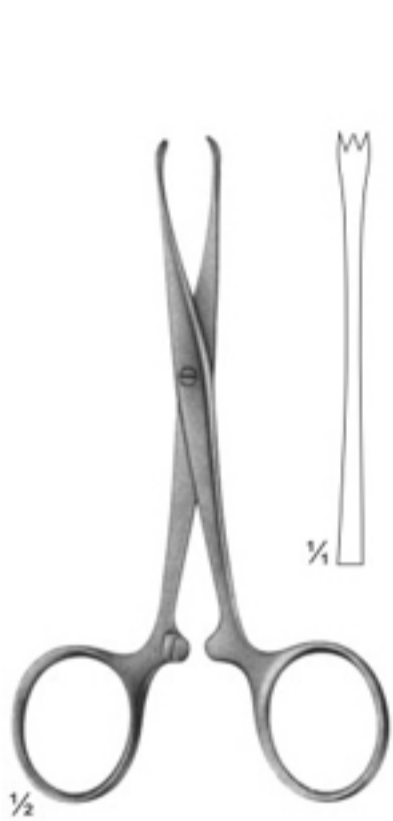

04-311
CHAPUT
 2 x 3 teeth
 125 mm

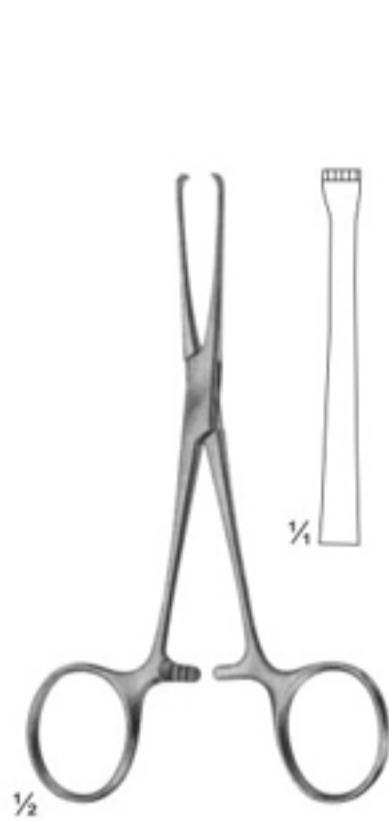

04-312
BABY-ALLIS
 4 x 5 teeth
 130 mm

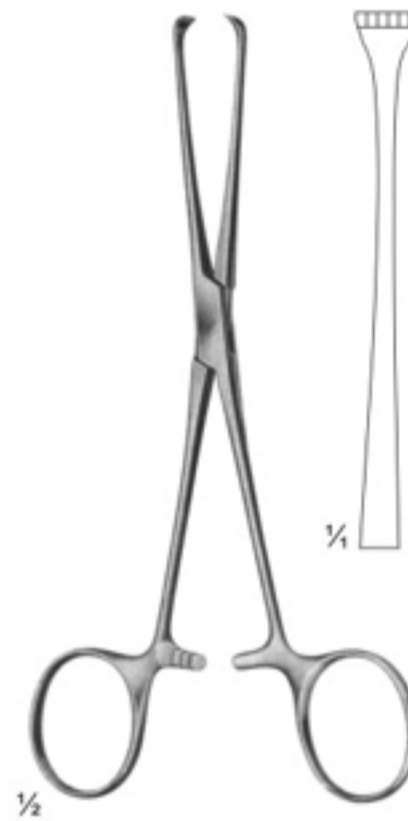

04-313
BOYS-ALLIS
 5 x 6 teeth sharp
 155 mm

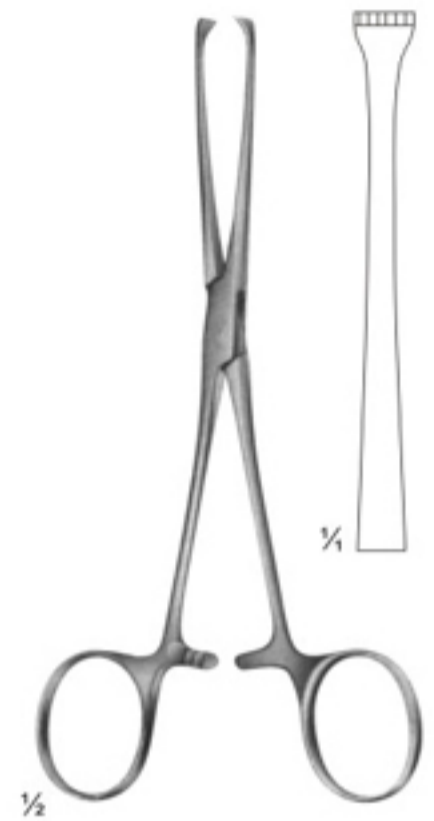

04-314
ALLIS
 5 x 6 teeth
 155 mm



04-315
LAHEY
 155 mm

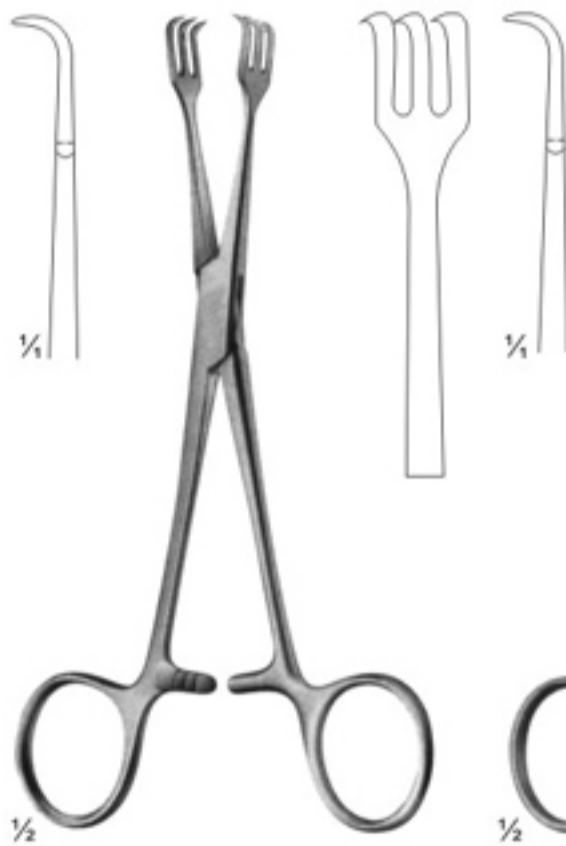

04-316
LAHEY
 155 mm

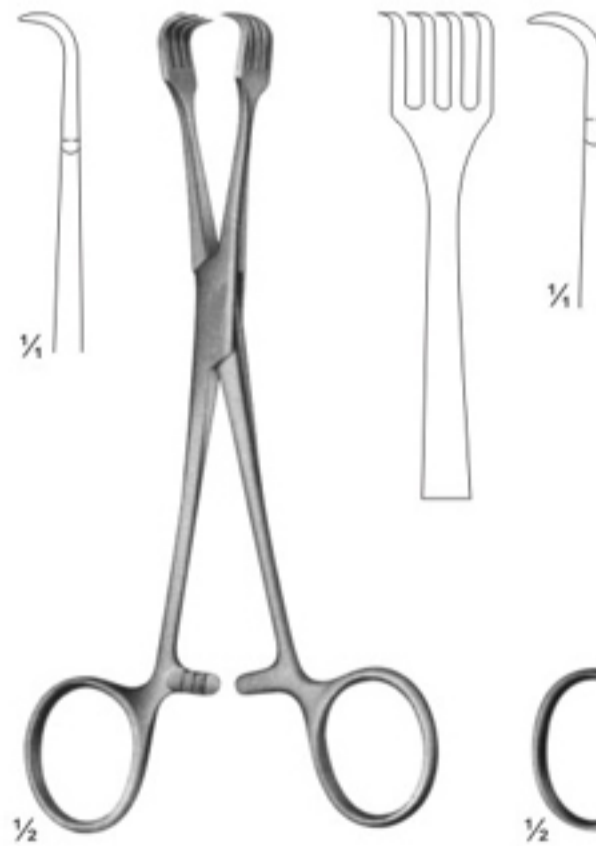

04-317
BRAUN
 155 mm

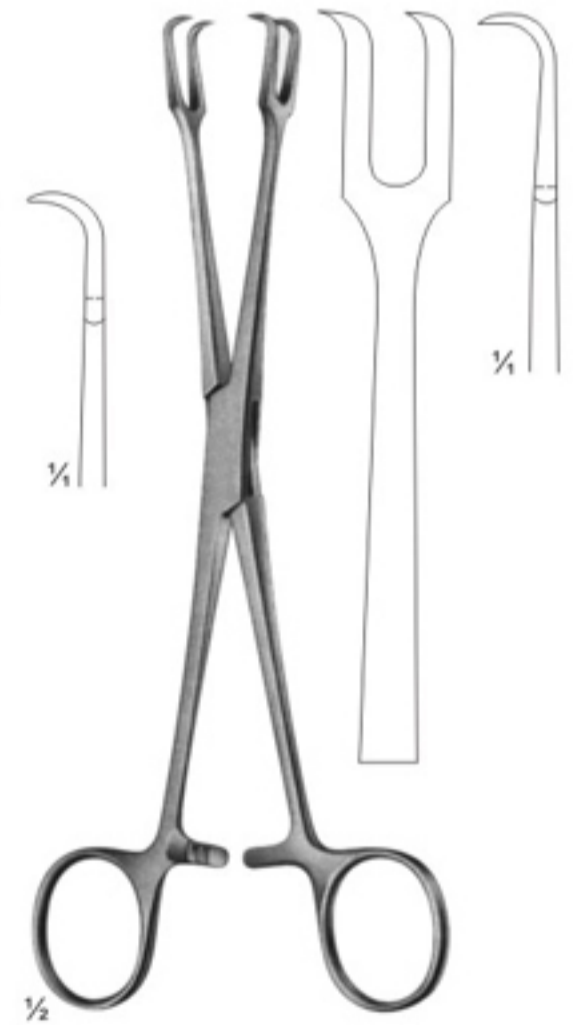





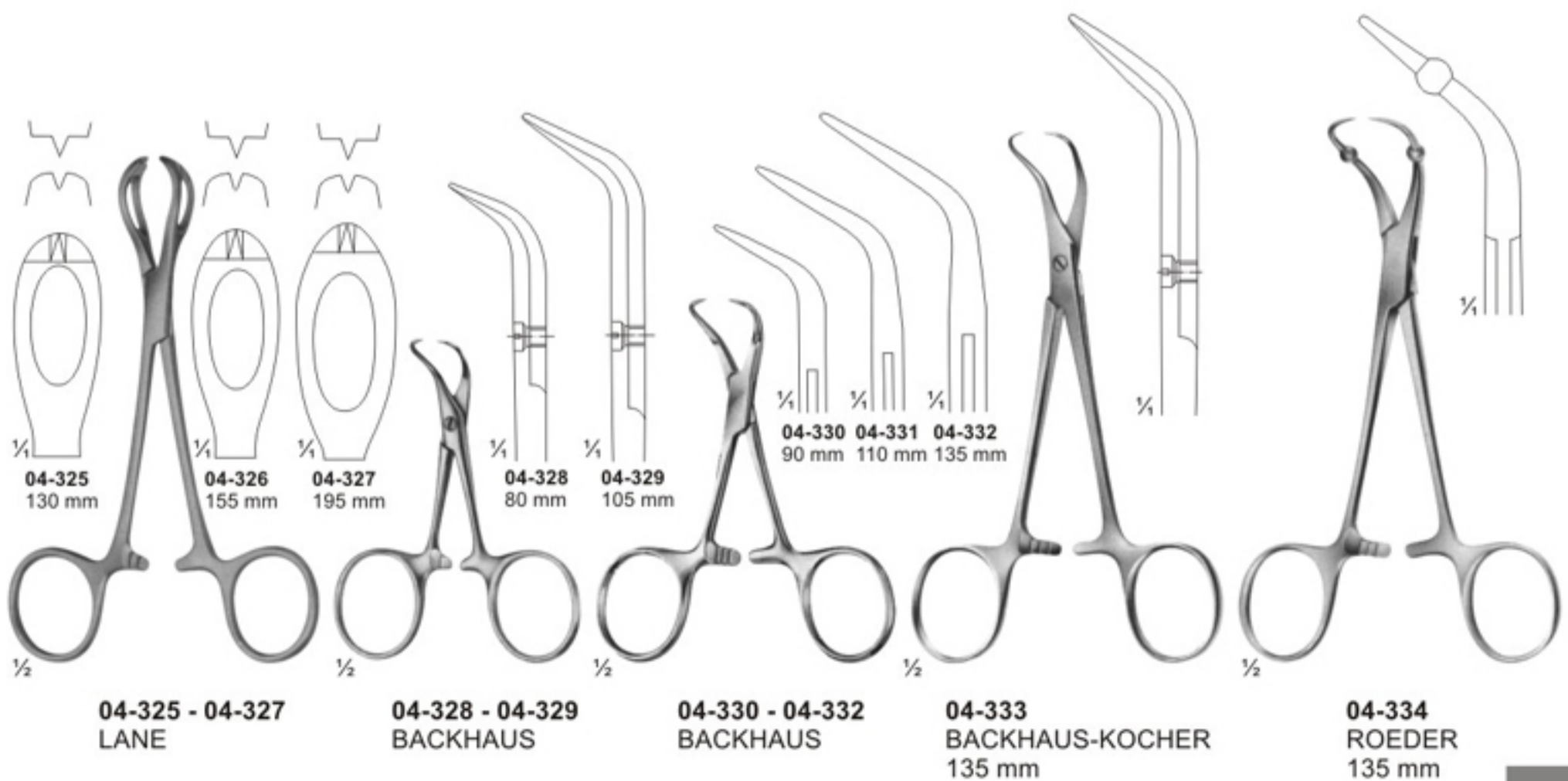
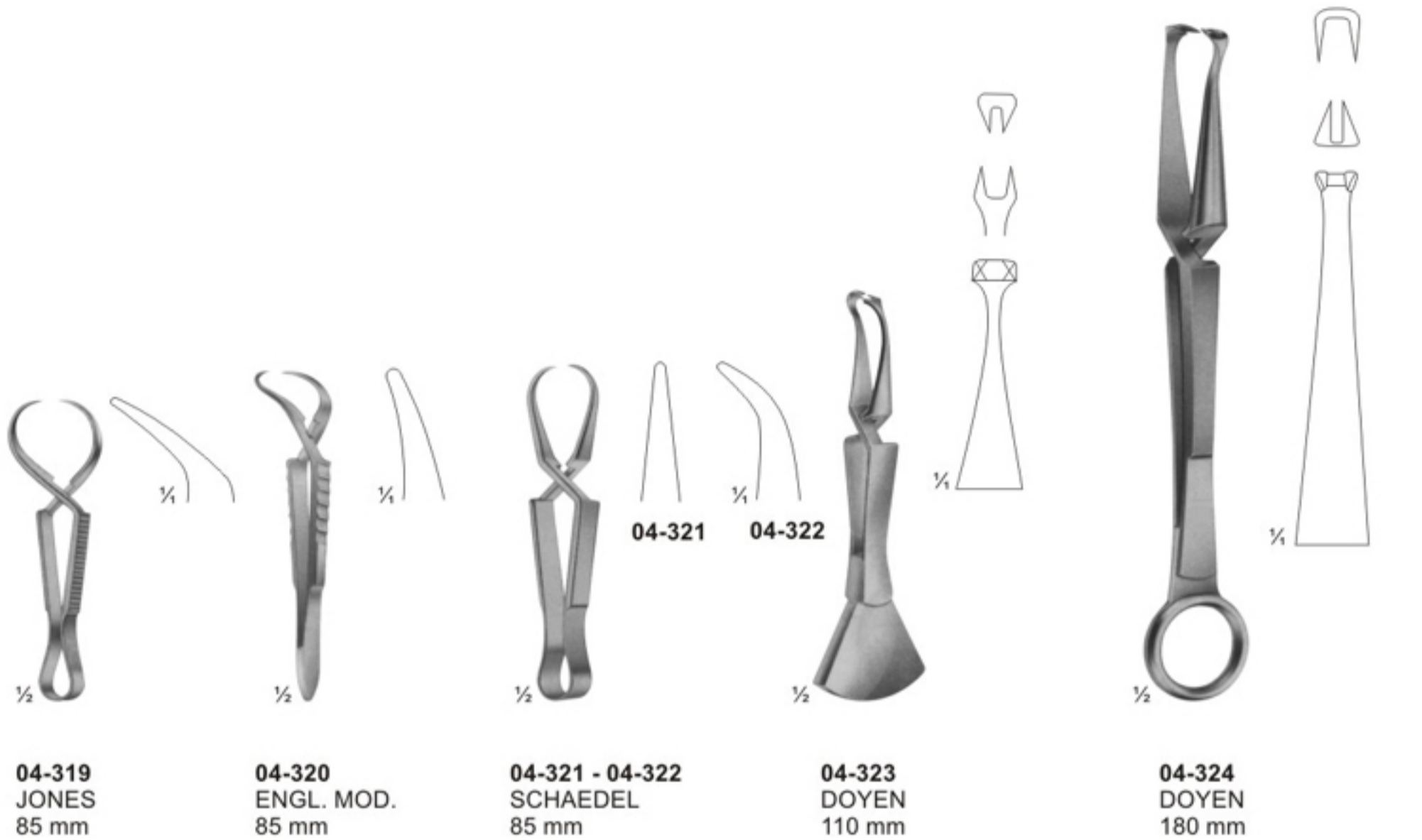





























04-318
MUSEUX
 200 mm

Towel Clamps



Muller Vessel Clips and Bulldog Clamps

Closing force

					
04-335 straight	04-336 curved	04-337 curved tips	04-338 angled shaped	04-339 MULLER knee-bent	04-340 Muller Ligature Forceps
80g 50g	80g 50g	80g 50g	80g 50g	80g 50g	80g 50g
					
04-341 35 mm	04-342 35 mm	04-343 45 mm	04-344 45 mm	04-345 DIEFFENBACH	04-347 DIEFFENBACH
				38 mm 48 mm	38 mm 48 mm
					
				04-349 DIEFFENBACH	04-350 DIEFFENBACH
				58 mm	58 mm
					
				04-351 - 04-357 JOHNS-HOPKINS	04-358 DE BAKEY- HESS
				38 mm 48 mm 56 mm 63 mm 70 mm 80 mm 91 mm	20 mm
					
04-359 length 50 mm jaws 27 mm	04-360 length 48 mm jaws 27 mm	04-361 GLOVER length 57 mm jaws 35 mm	04-362 DE BAKEY length 73 mm jaws 38 mm	04-363 DE BAKEY length 99 mm jaws 63 mm	04-364 DE BAKEY length 95 mm jaws 54 mm
					
				04-365 L. 80 mm	04-366 L. 90 mm
					
				04-367 L. 105 mm	04-368 L. 124 mm
					
				04-369 L. 78 mm	04-370 L. 86 mm
					
				04-371 L. 97 mm	04-372 L. 114 mm
					
				04-373 GLOVER L. 68 mm	04-374 GLOVER L. 96 mm
					
				04-375 L. 117 mm	04-376 GLOVER L. 65 mm
					04-377 L. 91 mm
					04-378 L. 110 mm

Delicate Haemostatic Forceps

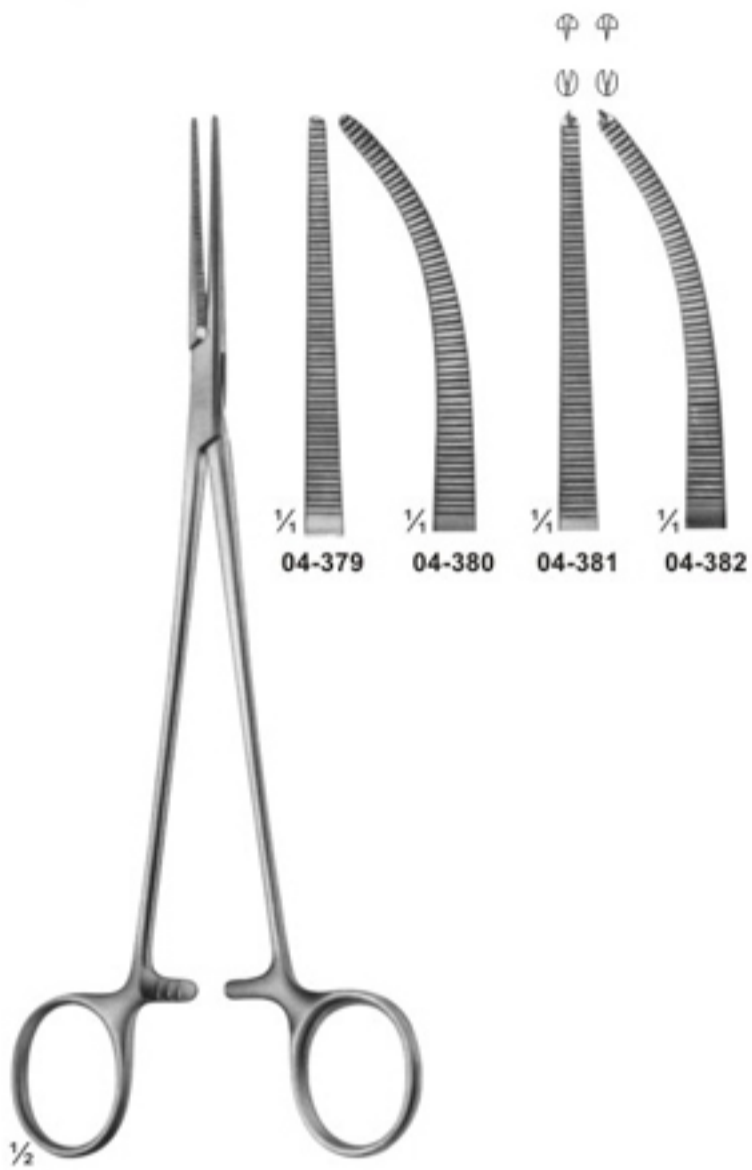

04-379 - 04-382
HALSTED-MOSQUITO
200 mm



04-383 - 04-387
HEISS
200 mm



04-388 - 04-389
HALSTED
215 mm

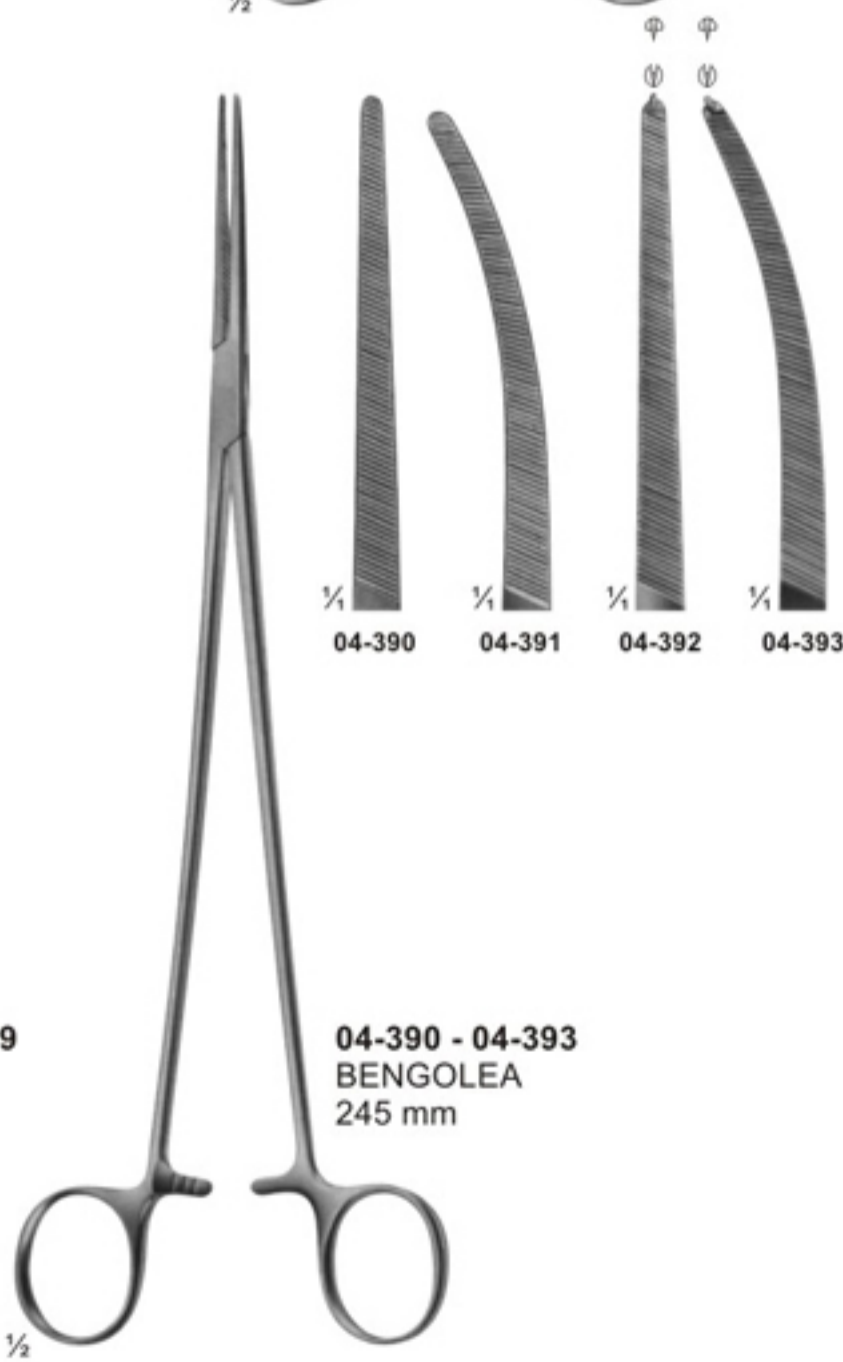

04-390 - 04-393
BENGOLEA
245 mm



04-394
CRAFOORD
245 mm

Delicate Haemostatic Forceps



04-395
CARREL
85 mm



04-396 - 04-399
BABY-MOSQUITO
(HARTMANN)
100 mm

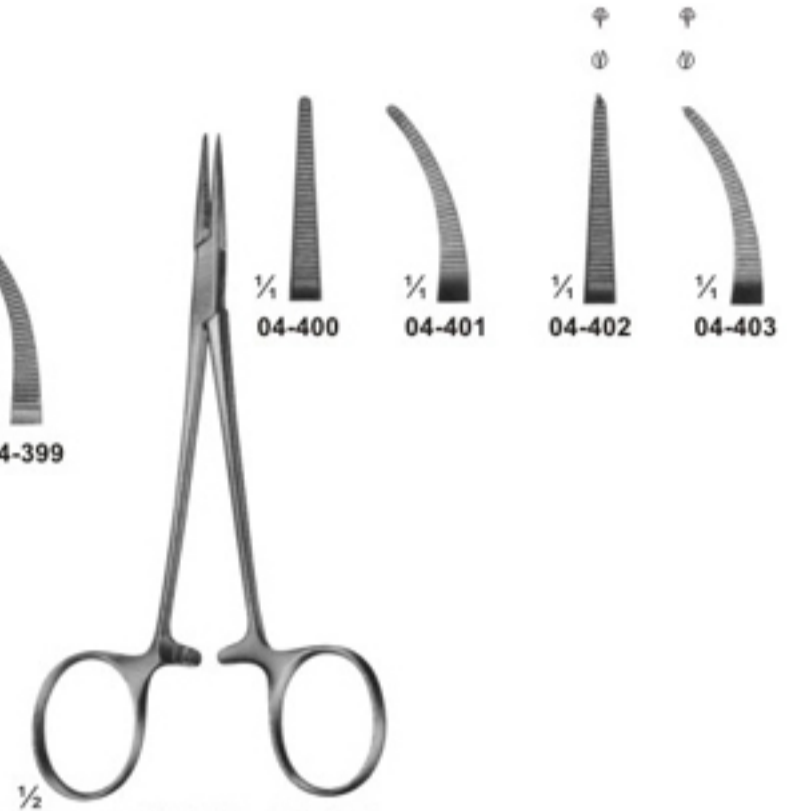

04-400 - 04-403
MICRO-HALSTED
125 mm



04-404 - 04-407
HALSTED-MOSQUITO
125 mm

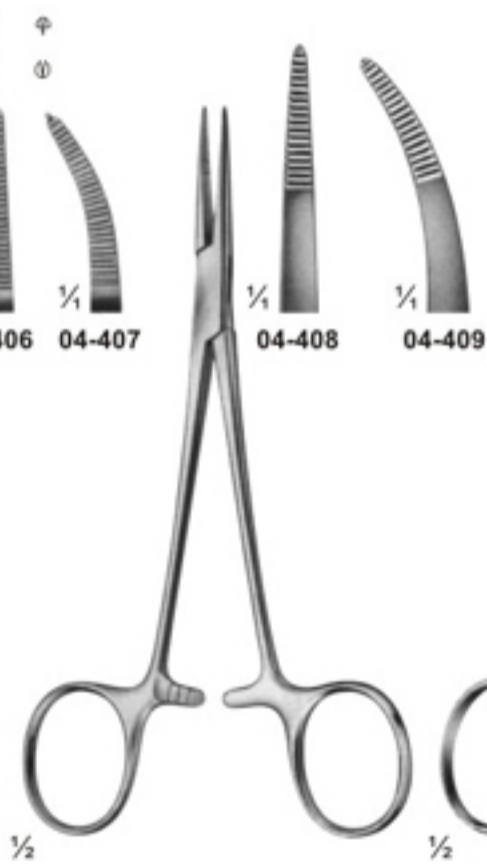

04-408 - 04-409
PROVIDENCE-HOSPITAL
140 mm

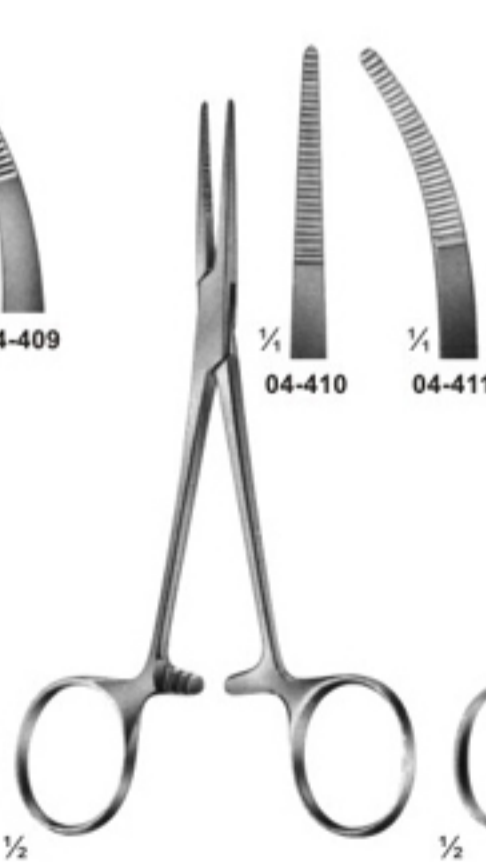

04-410 - 04-411
KELLY
140 mm

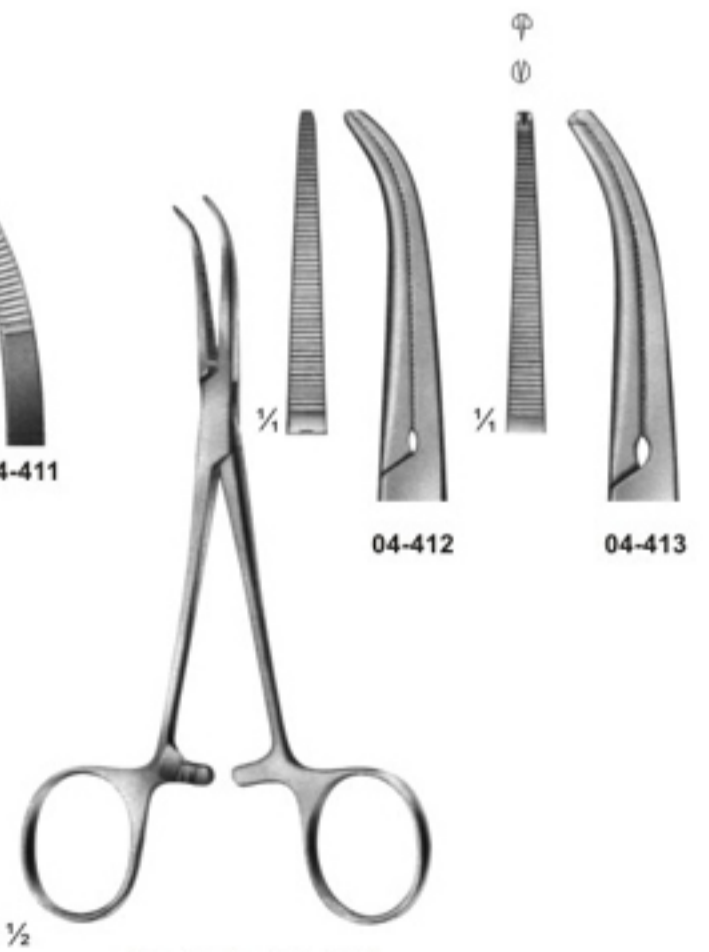

04-412 - 04-413
DANDY
Curved sideways
140 mm

Delicate Haemostatic Forceps

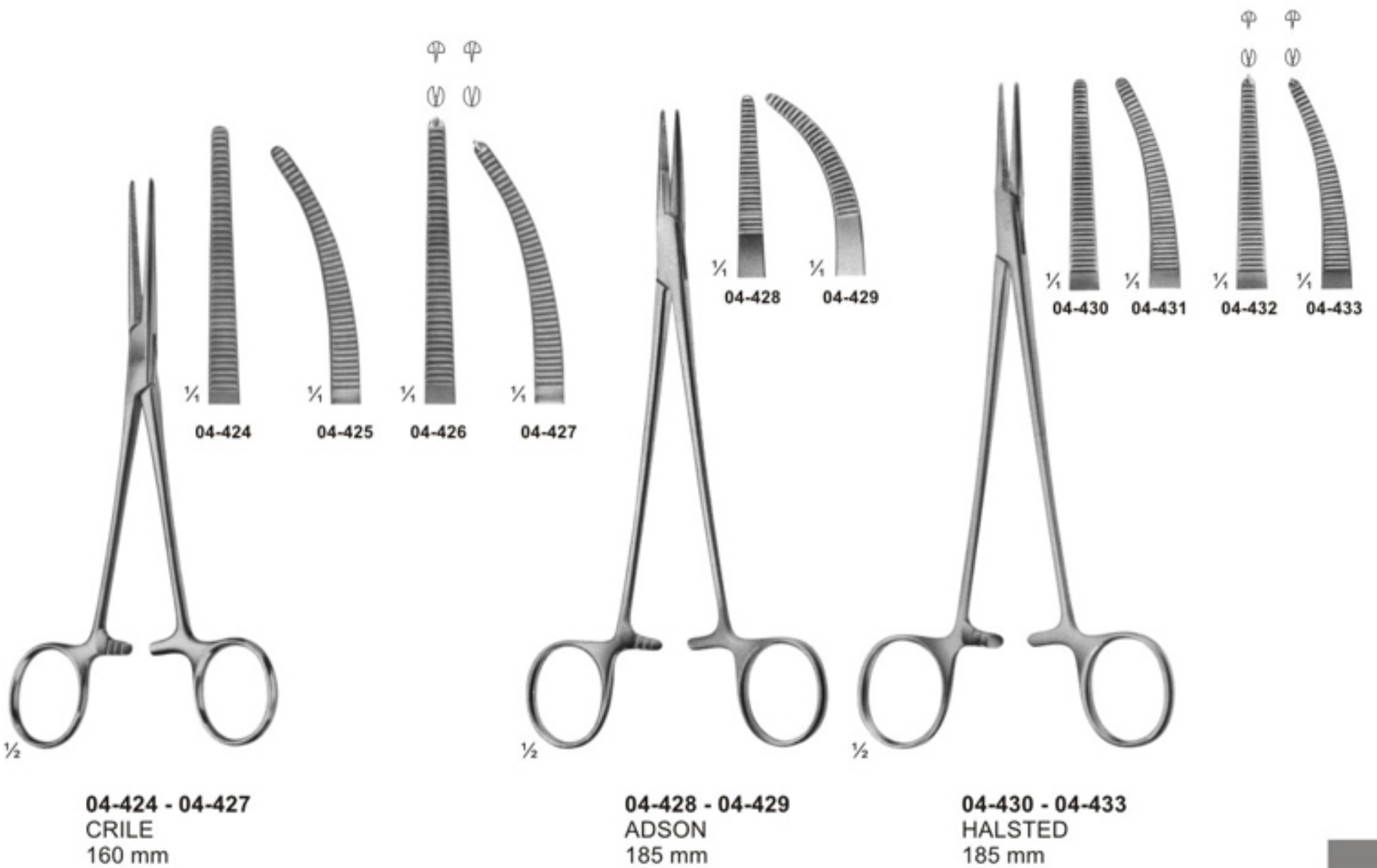
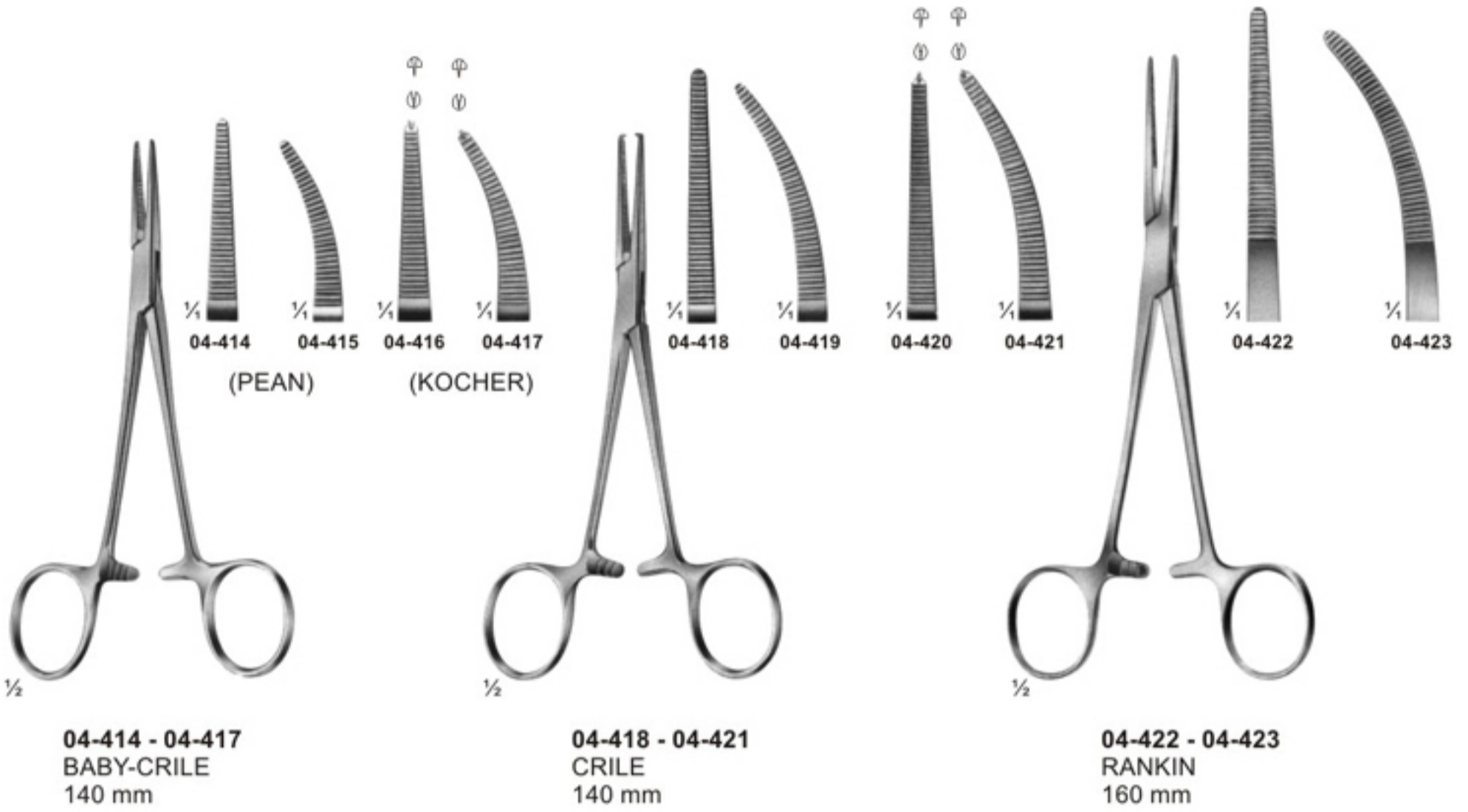

Haemostatic Forceps

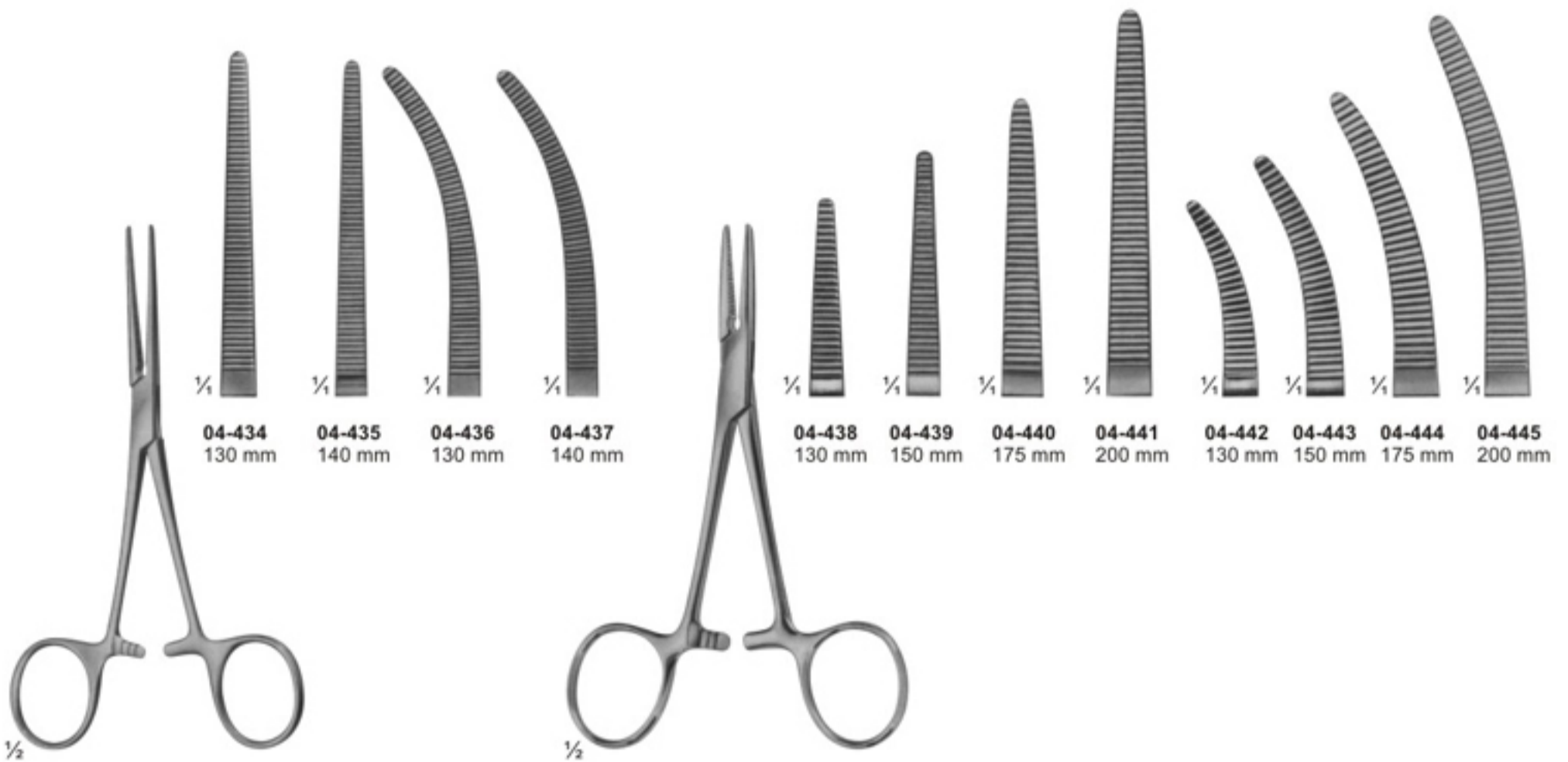

04-434 - 04-437
PEAN
Slender type

04-438 - 04-445
SPENCER-WELLS
Slender type

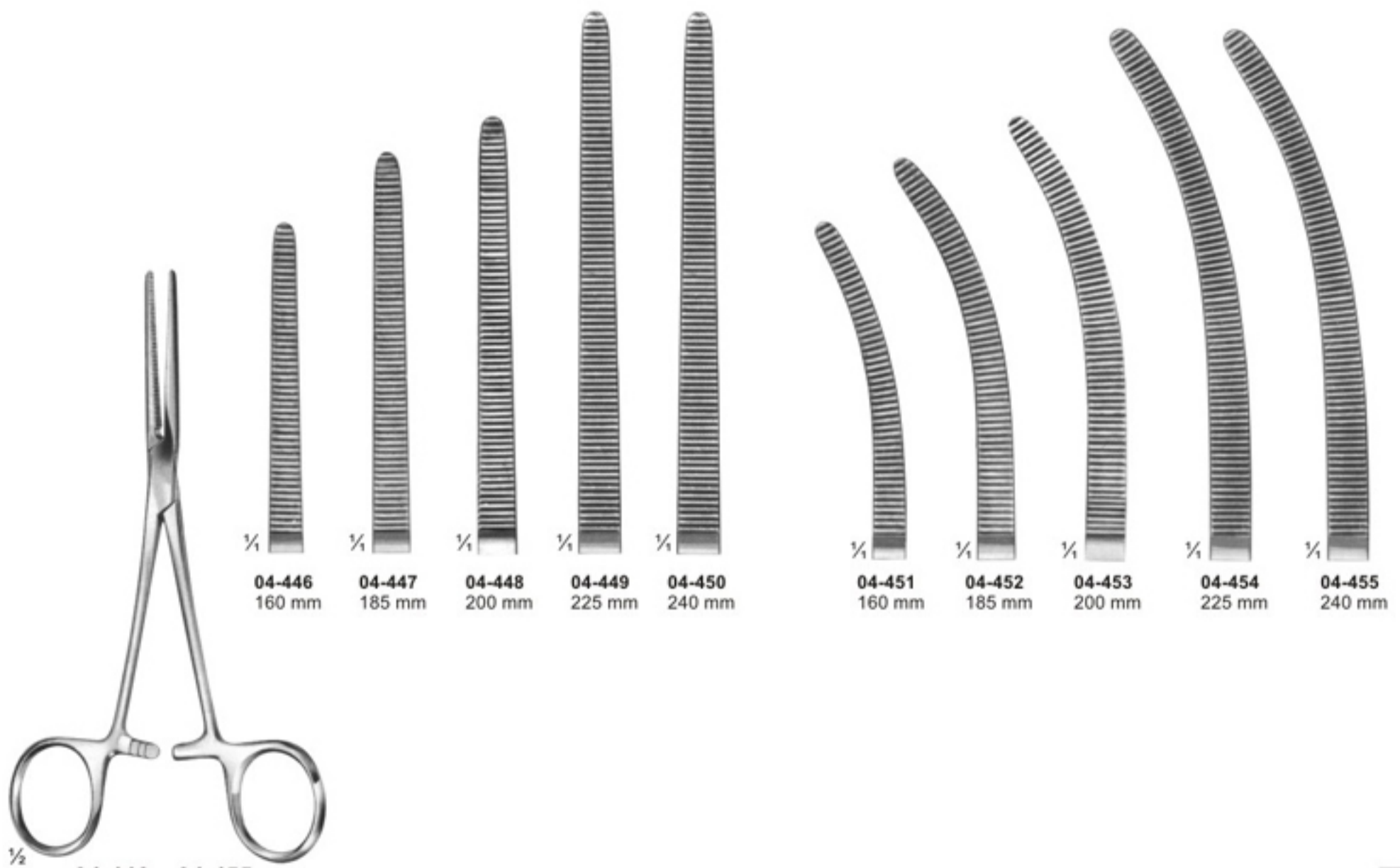

04-446 - 04-455
ROCHESTER-PEAN

Haemostatic Forceps



04-456 - 04-461
PEAN

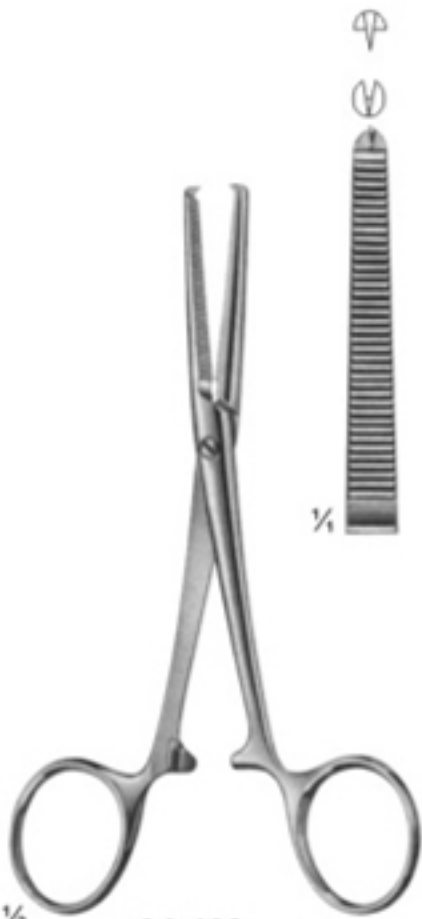
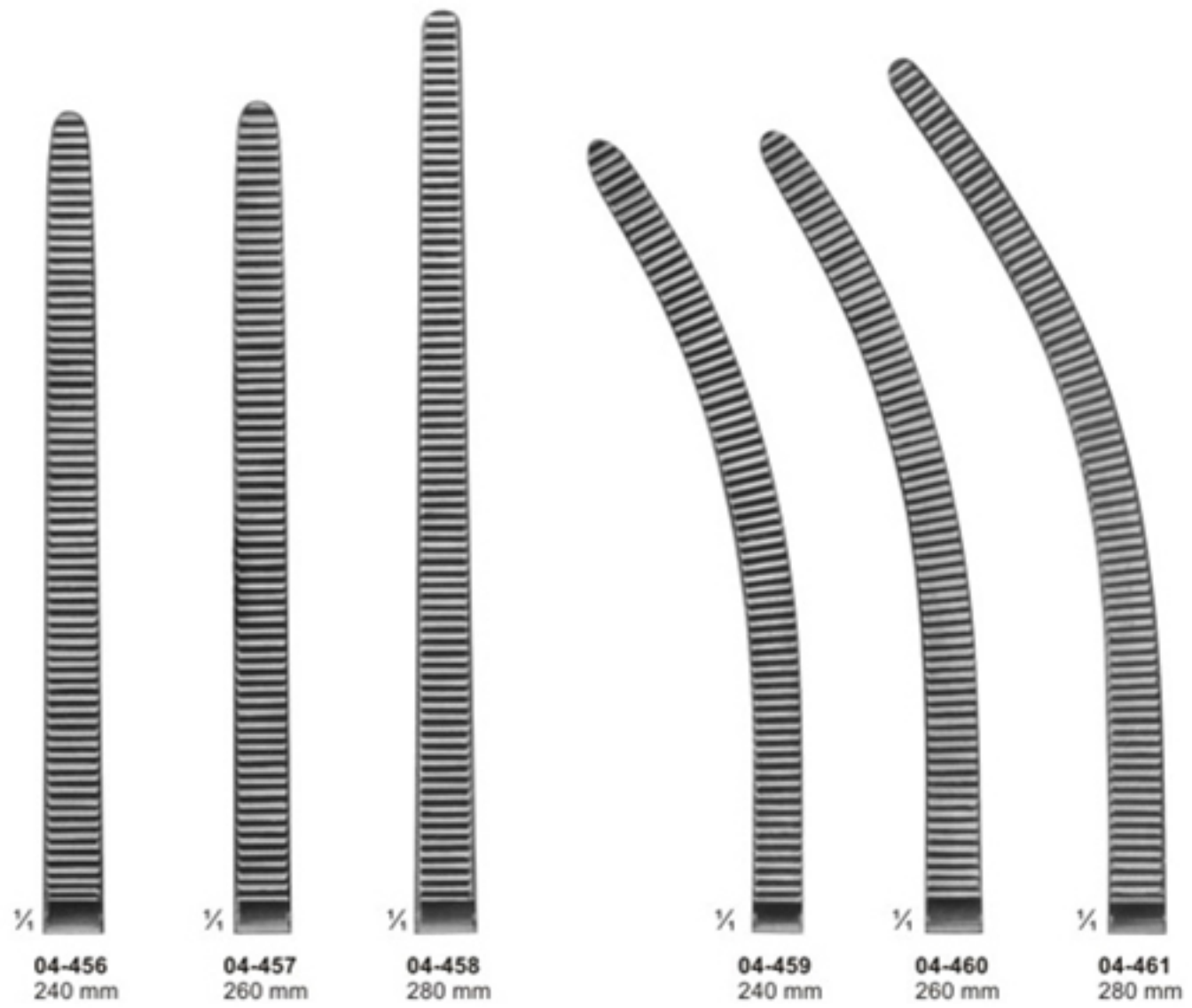

04-462
KOCHER
Strong Pattern
145 mm

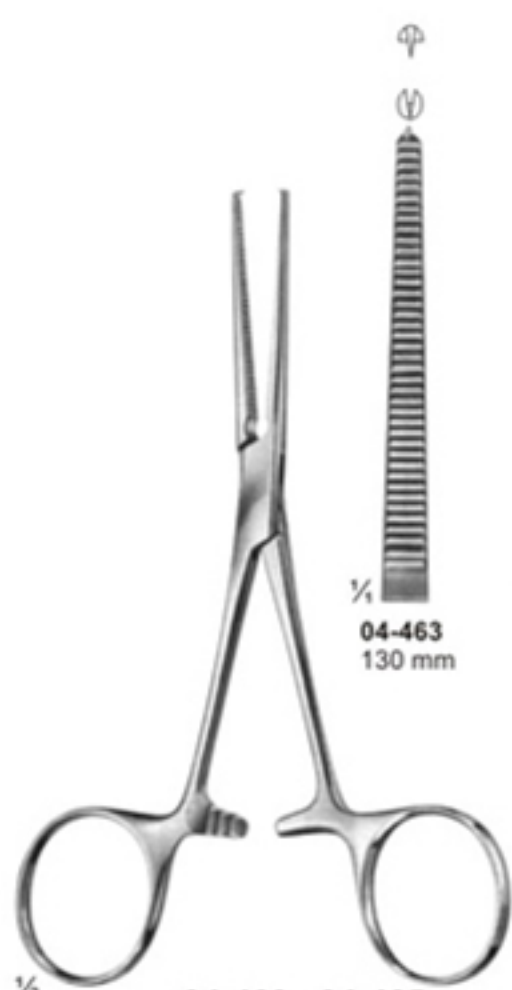

04-463 - 04-465
KOCHER

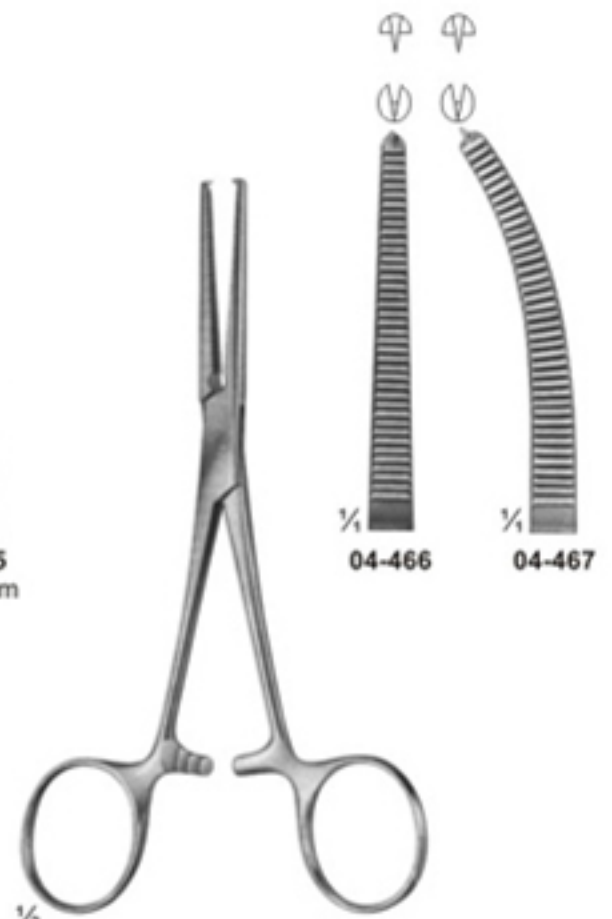
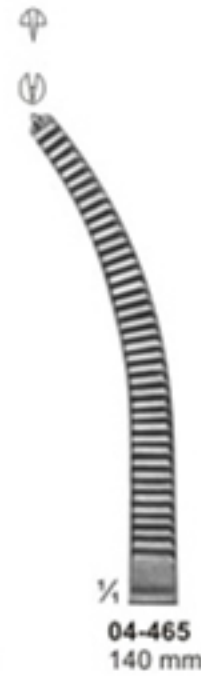

04-466 - 04-467
ROCHESTER-OCHSNER
140 mm

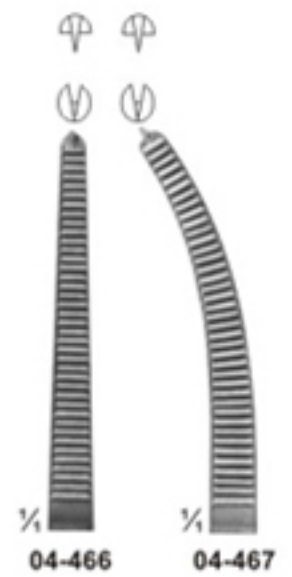

Haemostatic Forceps

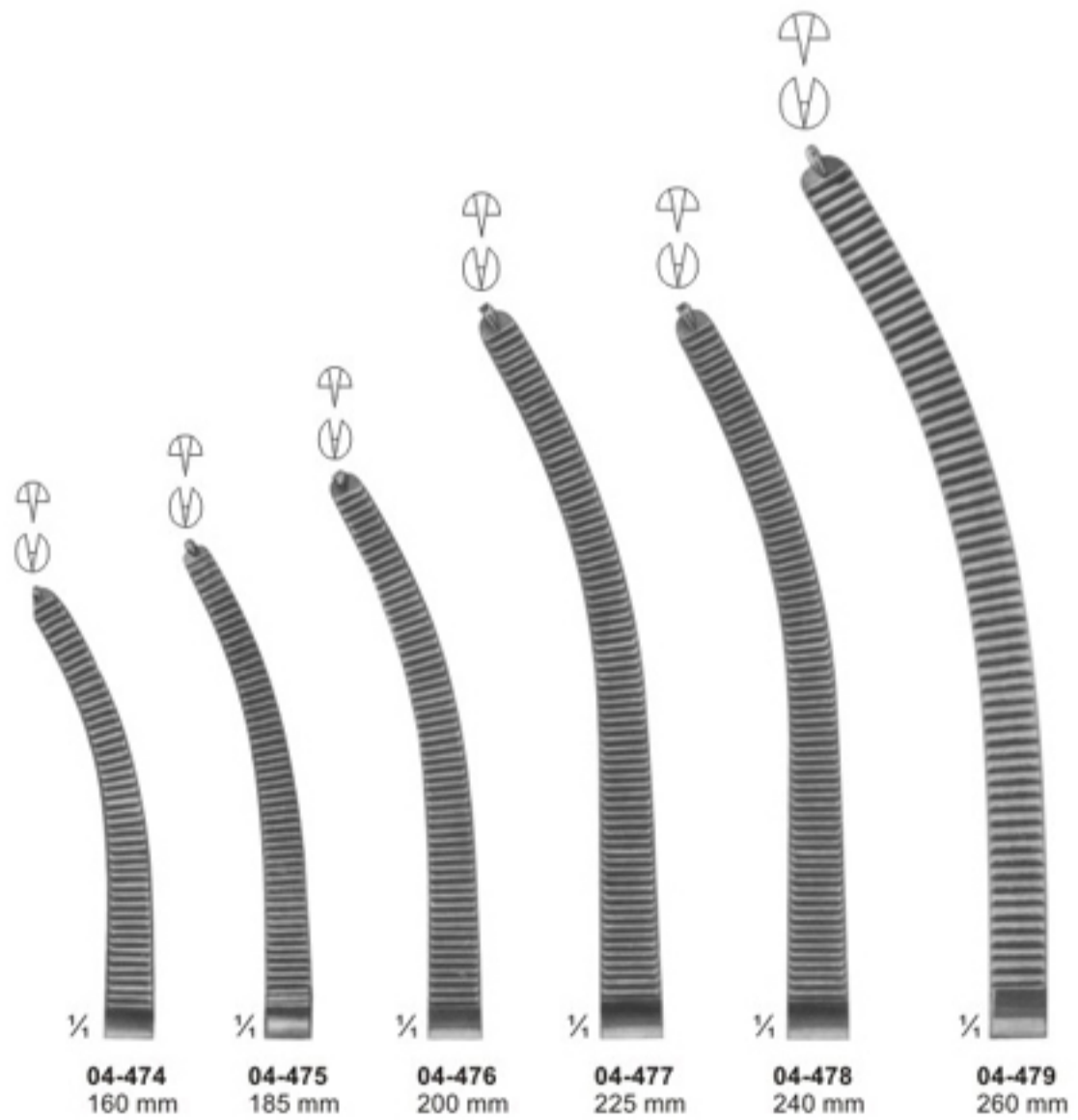
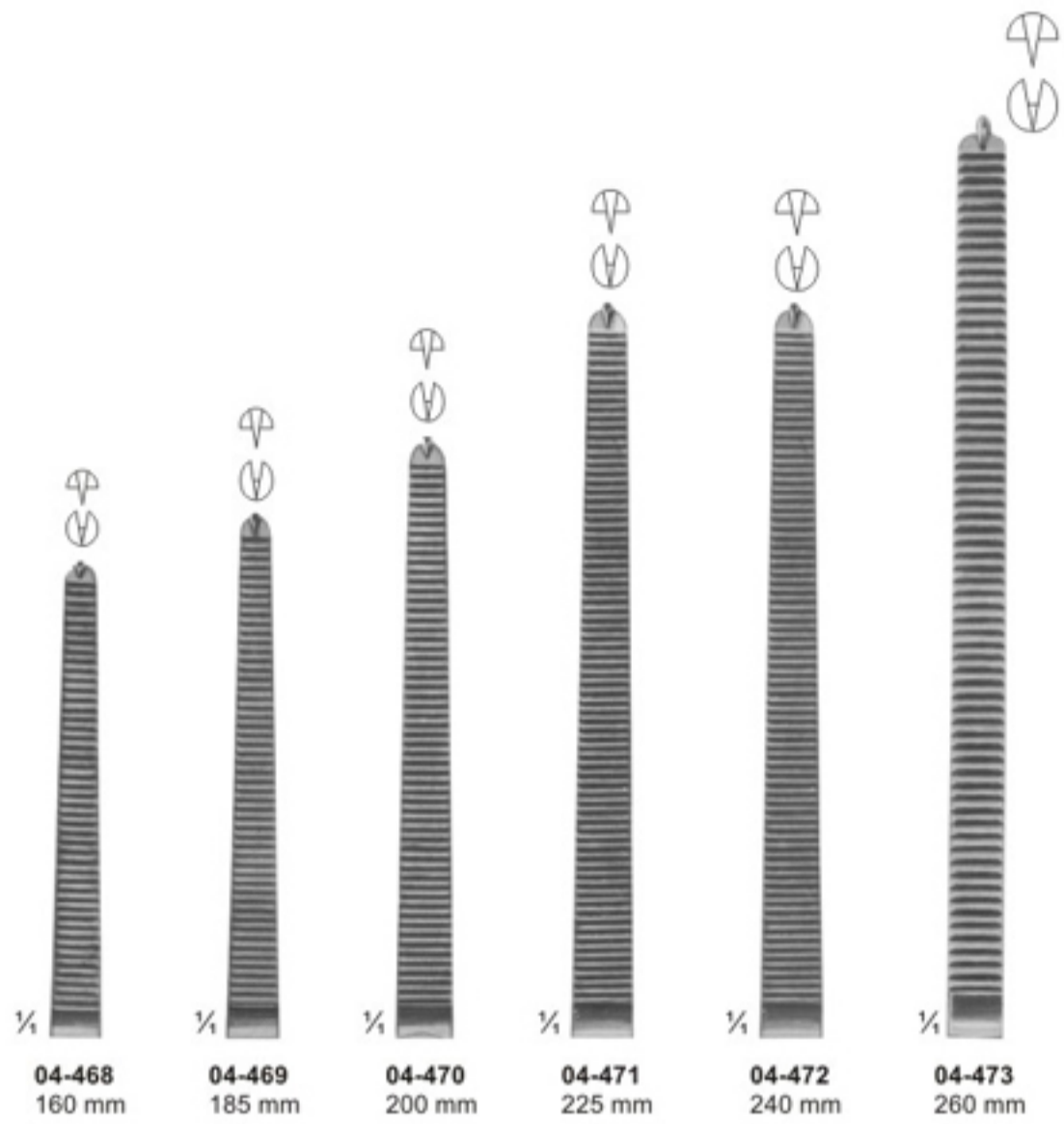

04-468 - 04-479
KOCHER-OCHSNER

Haemostatic Forceps

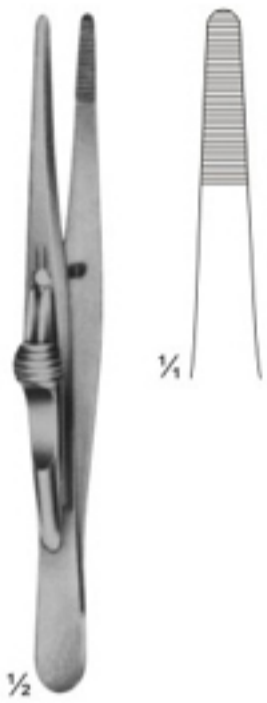

04-480
FRICKE
Artery forceps
130 mm

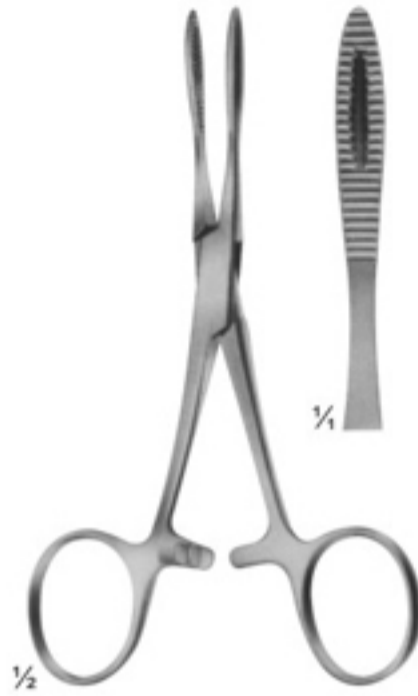

04-481
KRONLEIN
130 mm

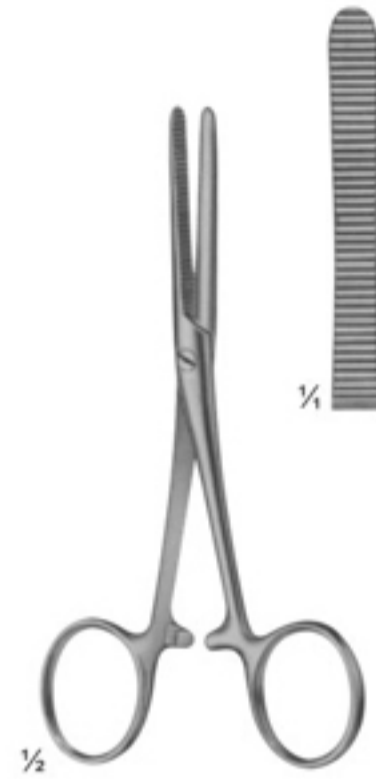

04-482
PEAN
125 mm



04-483 - 04-484
PEAN



04-484
140 mm

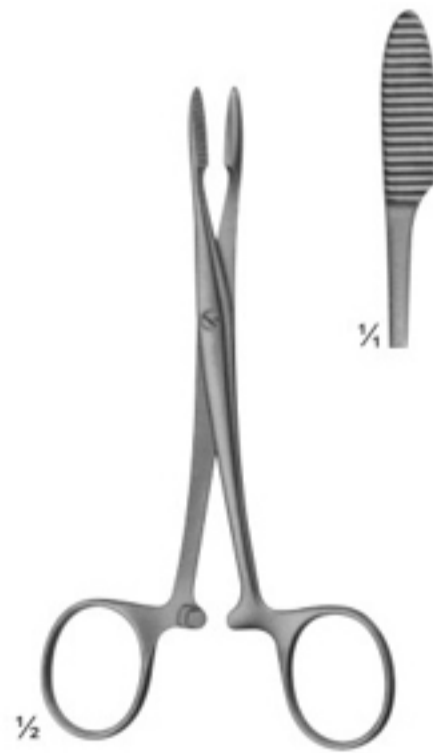

04-485
PEAN
125 mm

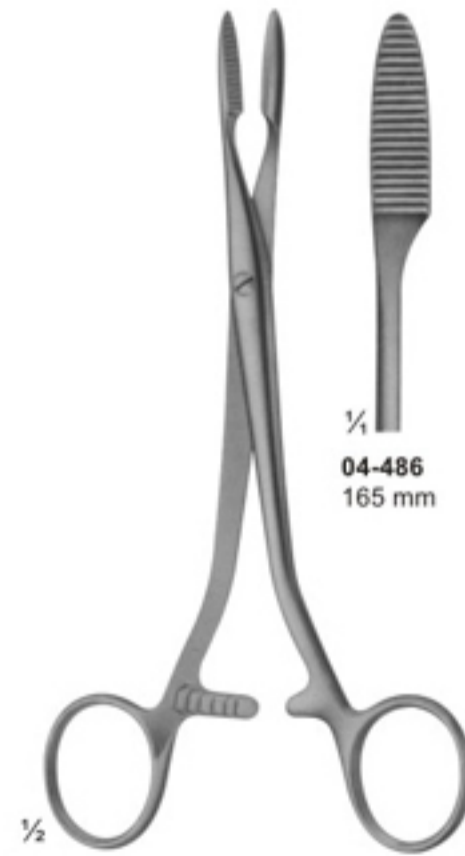

04-486 - 04-487
PEAN



04-486
165 mm



04-487
185 mm

Haemostatic Forceps, Special Pattern, Tonsil Forceps

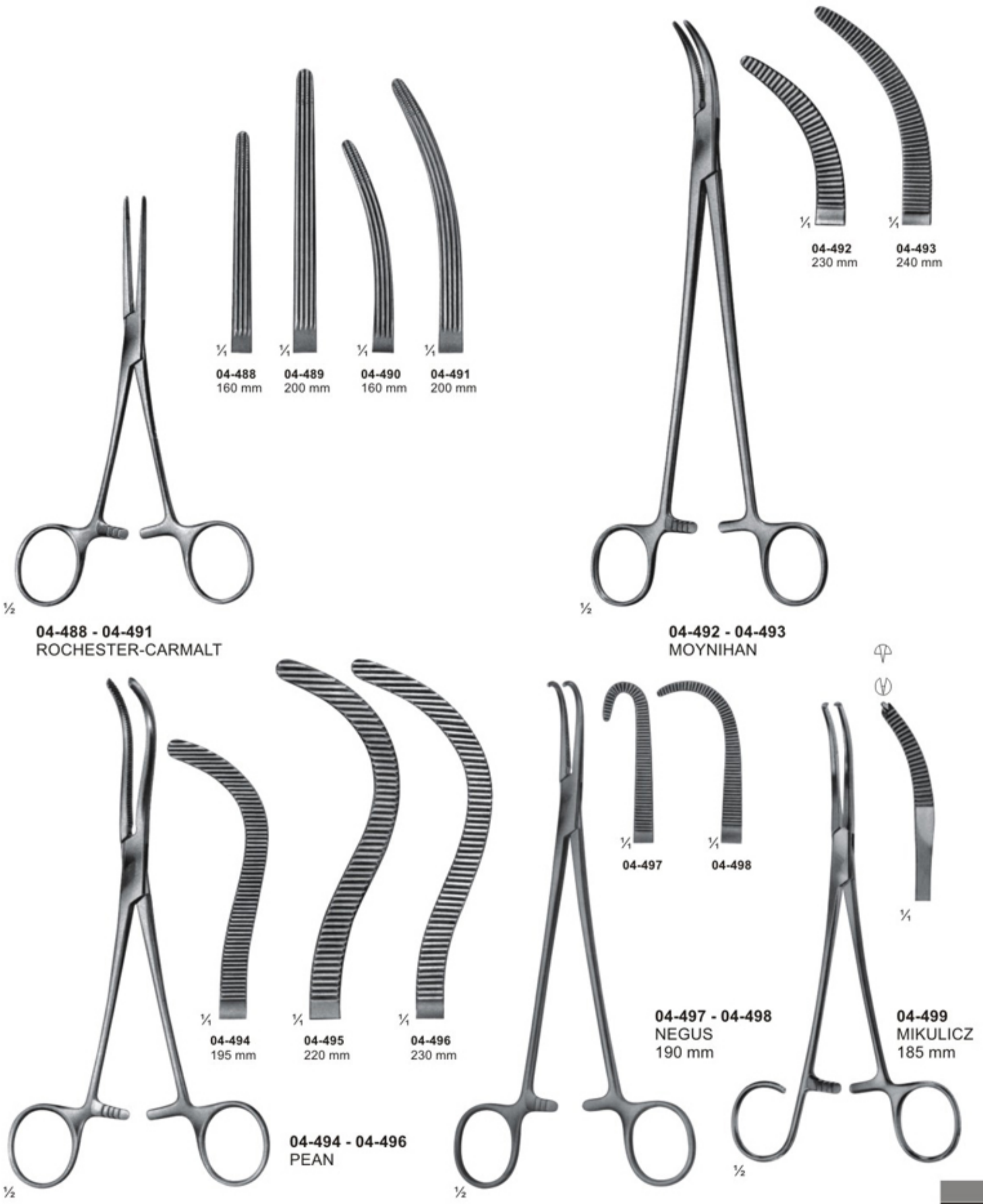

Dissecting- and Ligature Forceps



04-500
MIXTER-O'SHAUGNESSY
190 mm

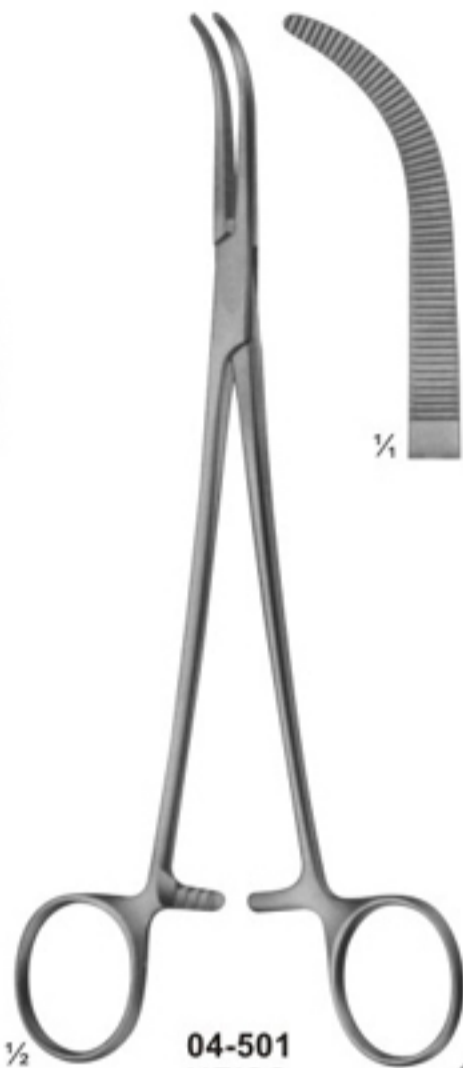

04-501
HEISS
195 mm

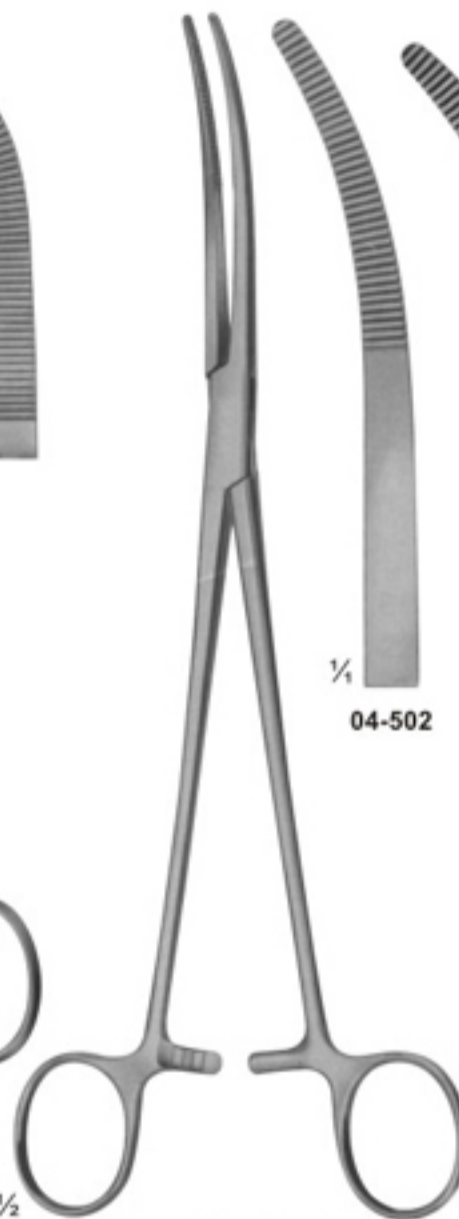

04-502 - 04-506
RUMEL
240 mm

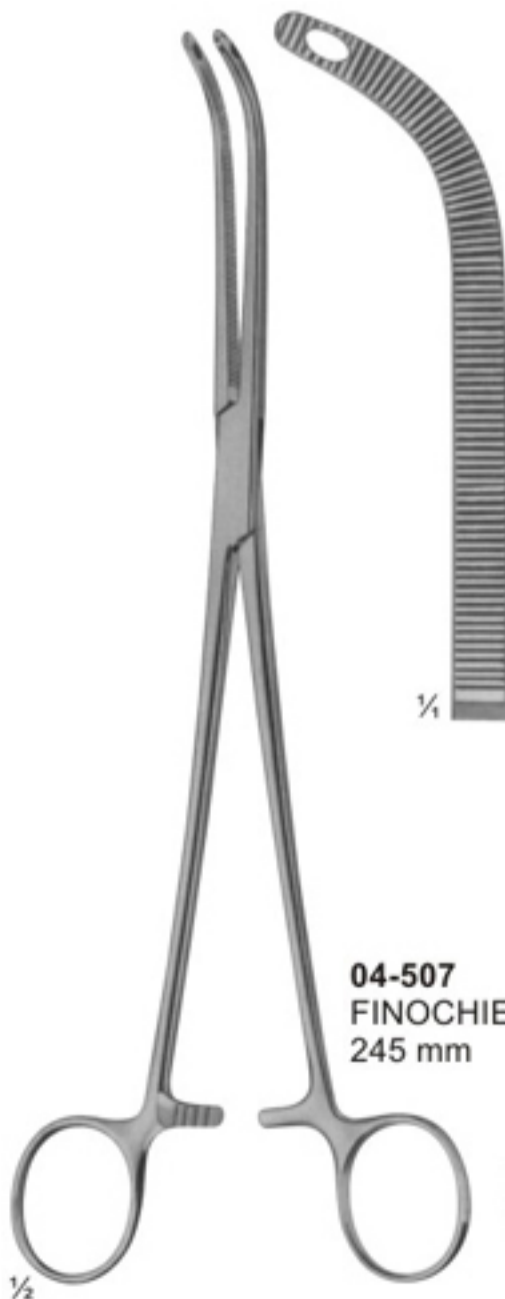
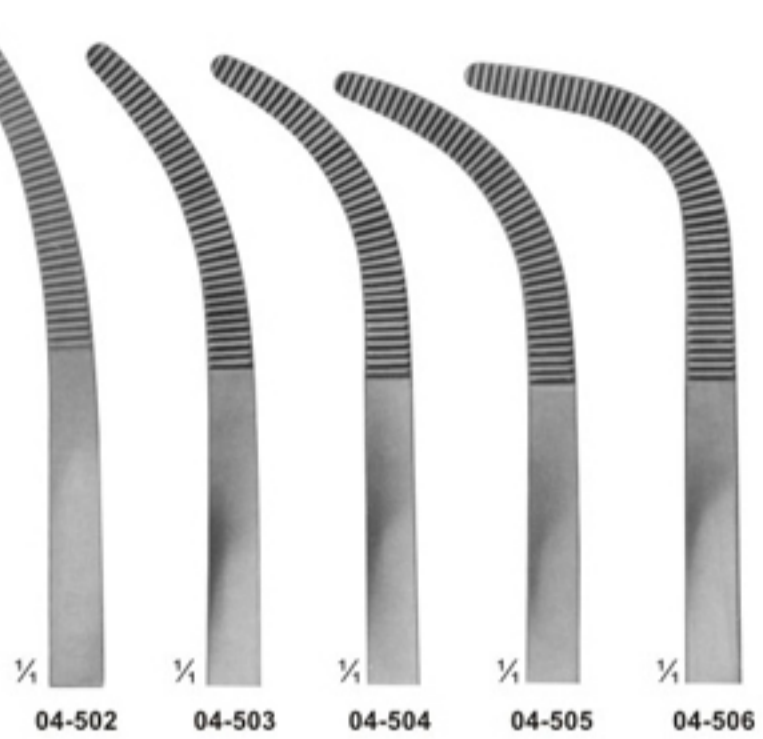

04-507
FINOCHIETTO
245 mm

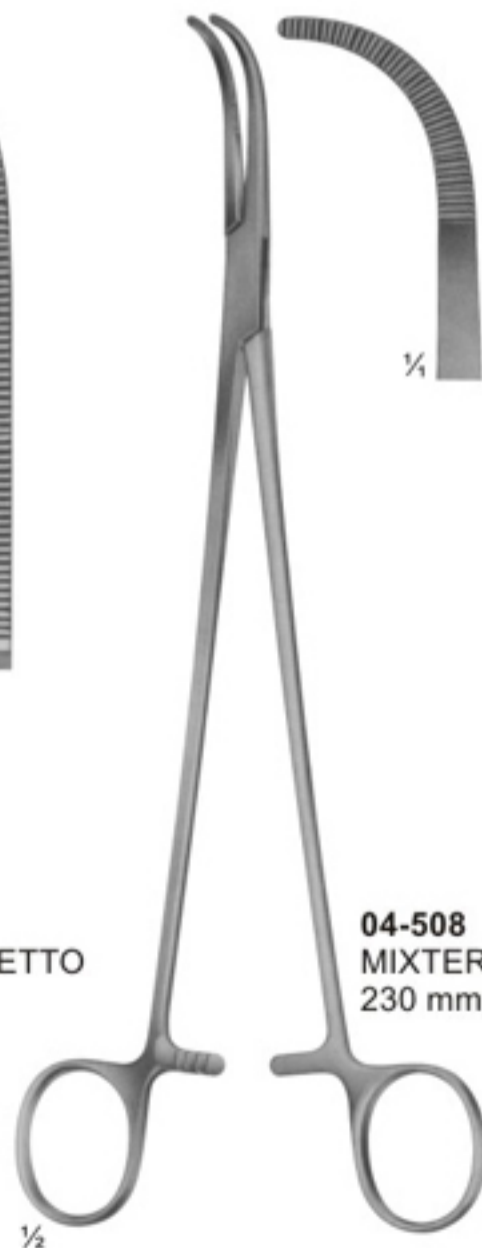

04-508
MIXTER
230 mm



04-509
LAWRENCE
270 mm

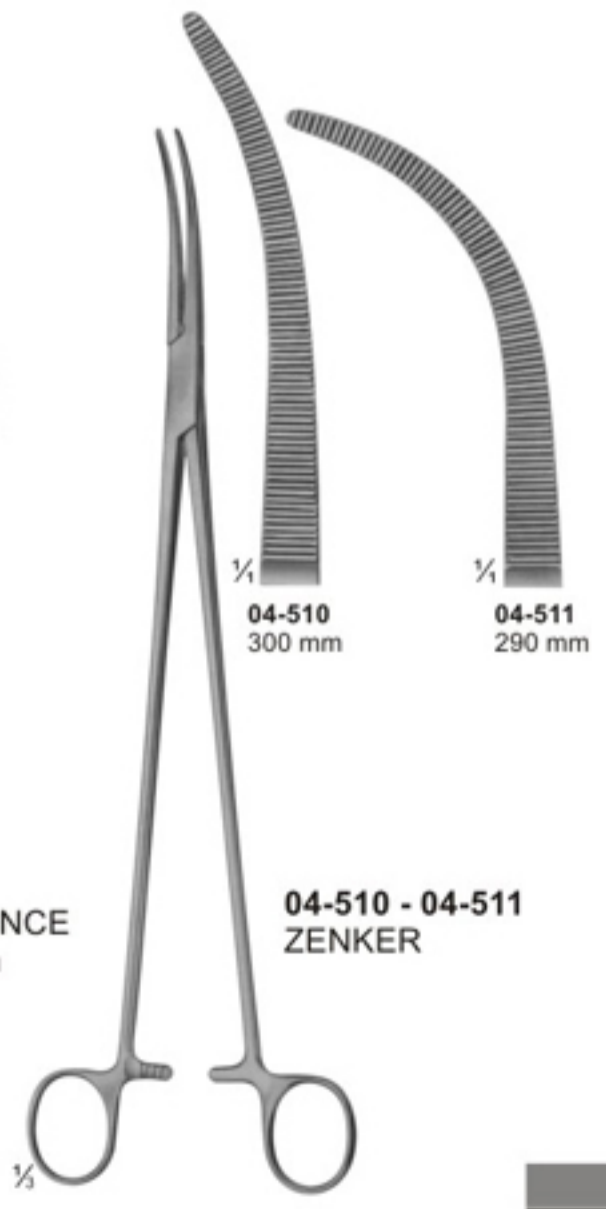

04-510 - 04-511
ZENKER

Hysterectomy Forceps, Vaginal Clamps and Compression Forceps



04-512
WERTHEIM
Hysterectomy forceps
255 mm

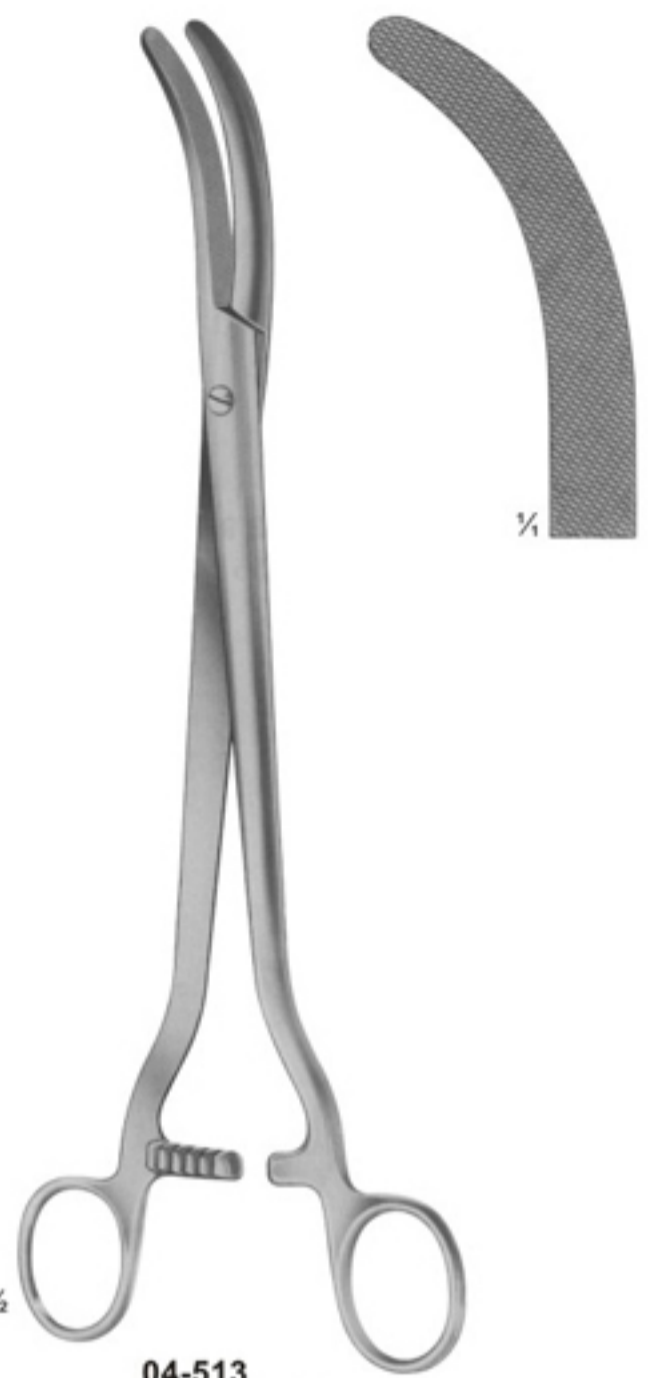

04-513
WERTHEIM
Parametrium clamp
260 mm



04-514 - 04-516
DICK



04-514 255 mm
04-515 265 mm
04-516 275 mm

**Hysterectomy Forceps, Vaginal Clamps
and Compression Forceps**



**04-517
WERTHEIM
250 mm**

1/2

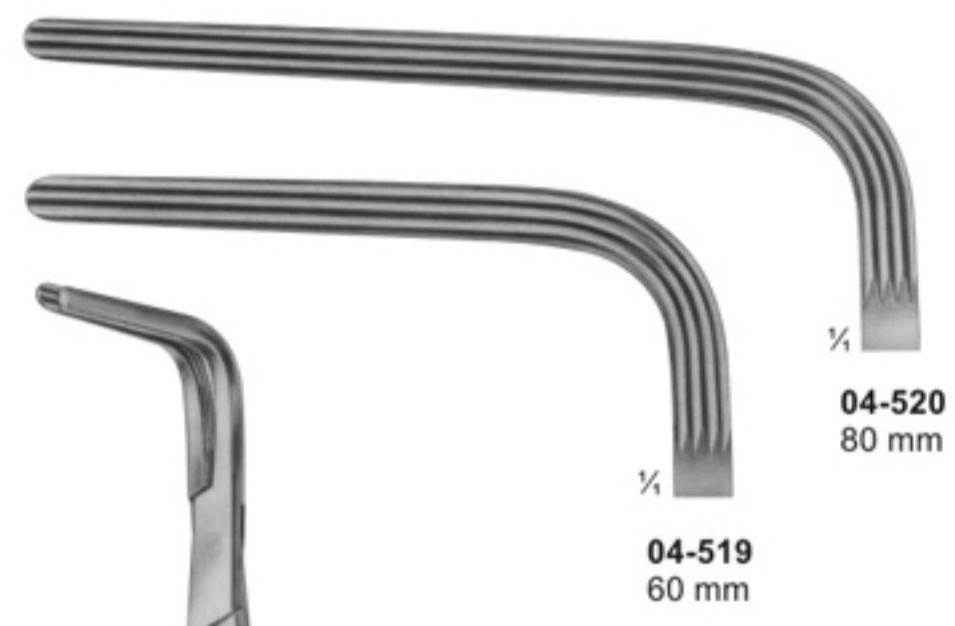

**04-519
60 mm**

**04-520
80 mm**

1/4

1/4



**04-518
WERTHEIM-CULLEN
215 mm**

1/2



**04-519 - 04-520
230 mm**

1/2

Needle Holders for micro surgery



05-101
ROHRSCHEIDER
with copper inserts
100 mm



05-102
KALT
with catch
135 mm



05-103
ARRUGA
with catch
135 mm



05-104 - 105
CASTROVIEJO
with catch
145 mm



05-106 - 107
without Catch
160 mm



05-108 - 109
without catch
185 mm



05-110 - 111
JACOBSON
185 mm



05-112
without catch
195 mm



05-113 - 114
YASARGIL
with catch
200 mm

Needle Holders



Needle Holders

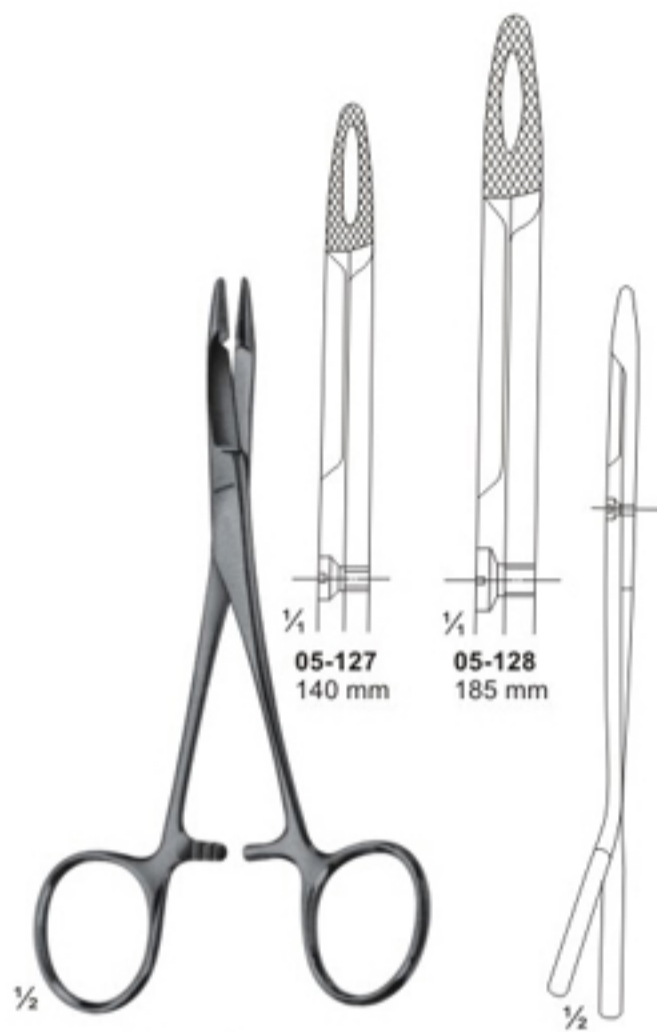

05-127 - 128
HEGAR-OLSEN
255 mm

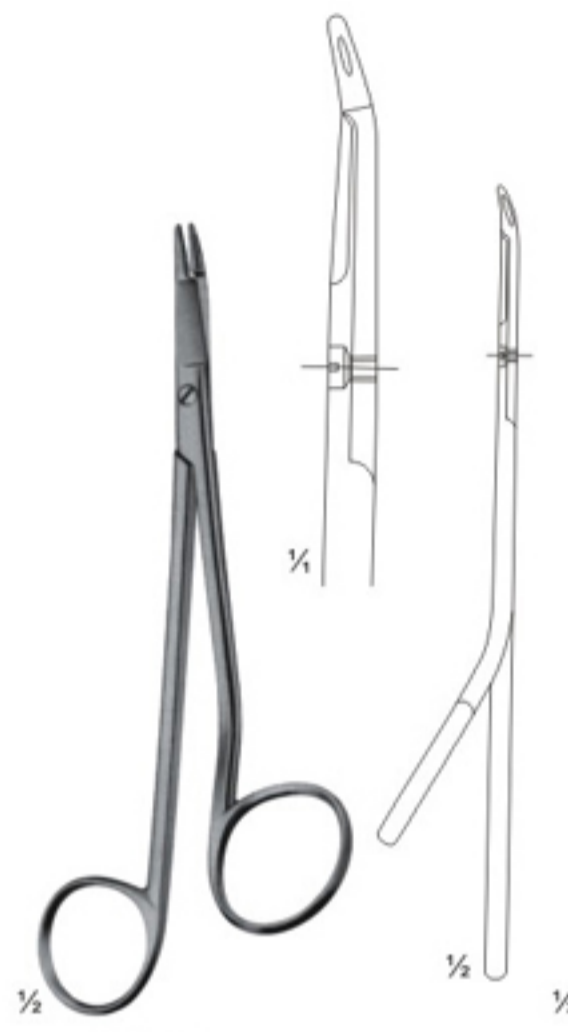

05-129
GILLIES
150 mm



05-130
GILLIES
160 mm

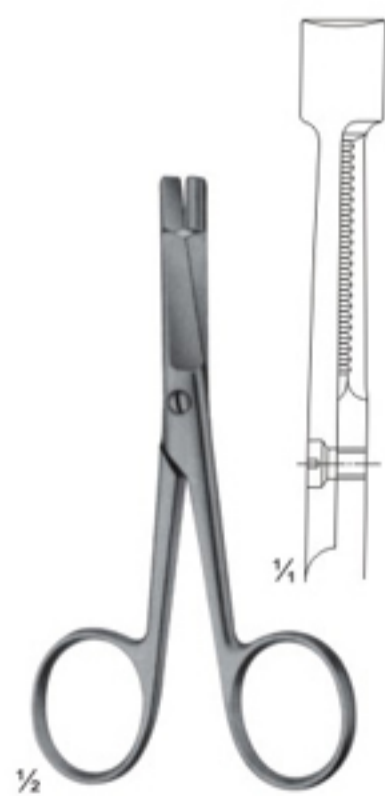

05-131
EISELSBERG
115 mm

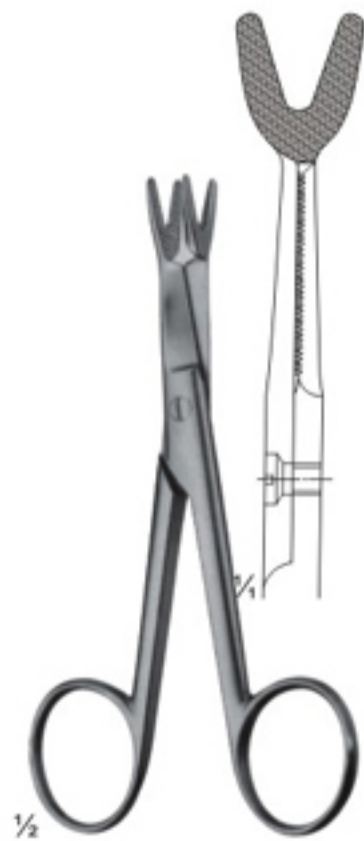

05-132
SCHOEMAKER-LOTH
125 mm



05-133
CRILE
150 mm



05-134
TOENNIS
Elastic pattern for dura-or
intestinal suture. 180 mm

Needle Holders

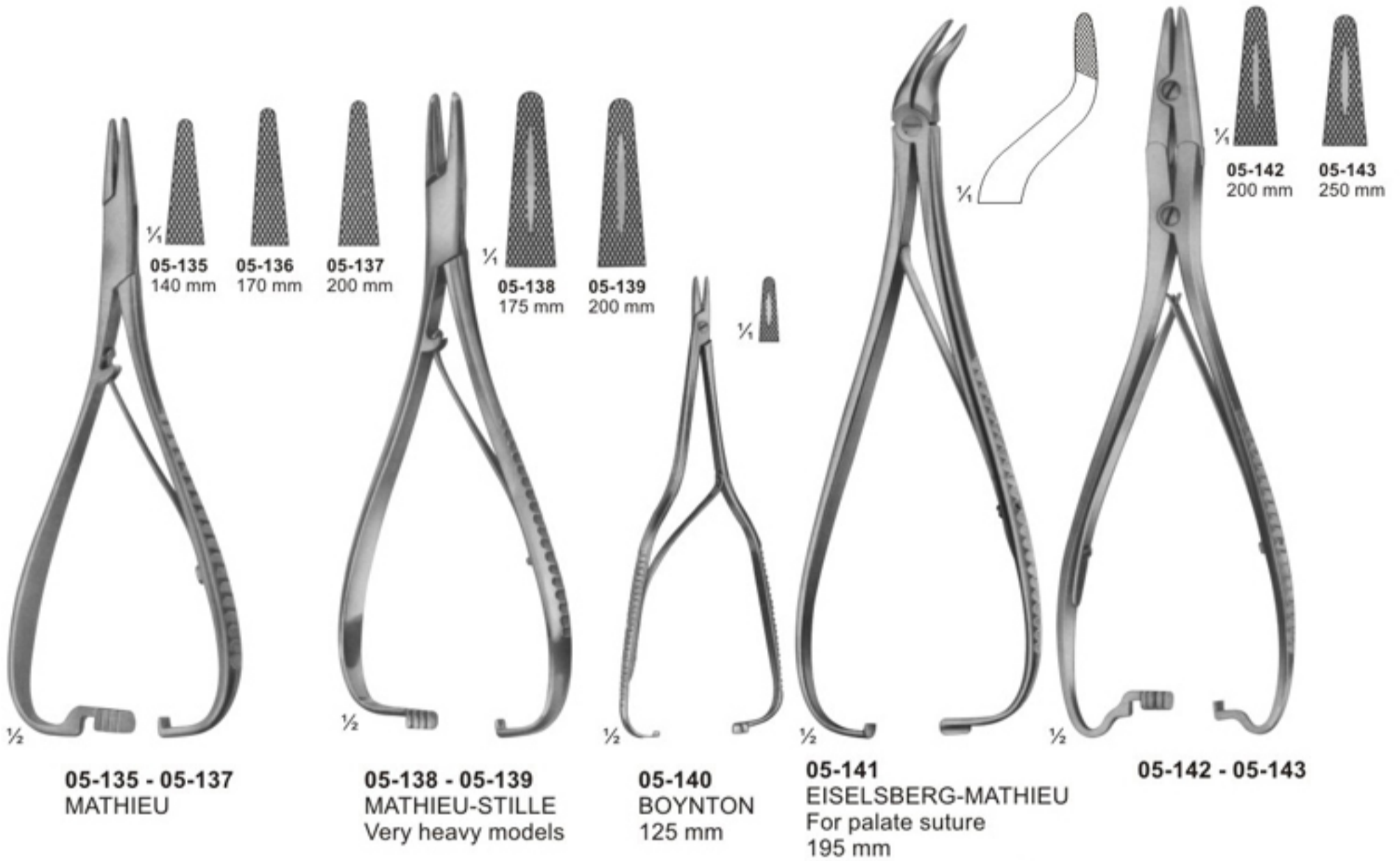

Suture Instruments - Reverdin Needles

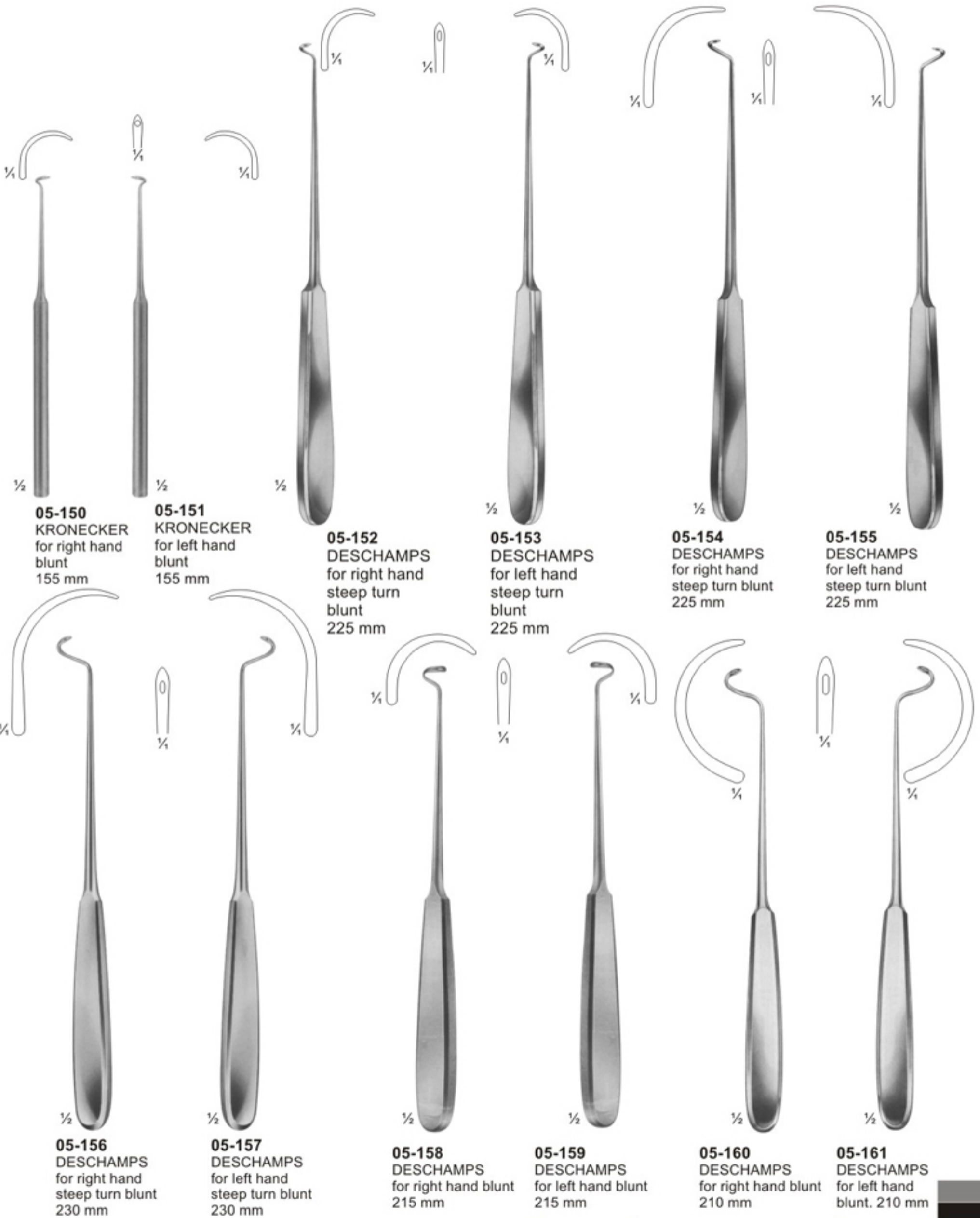

Probes



05-162 130 mm
05-163 145 mm
05-164 160 mm
 Directors



05-165
DOYEN
 145 mm
 Directors

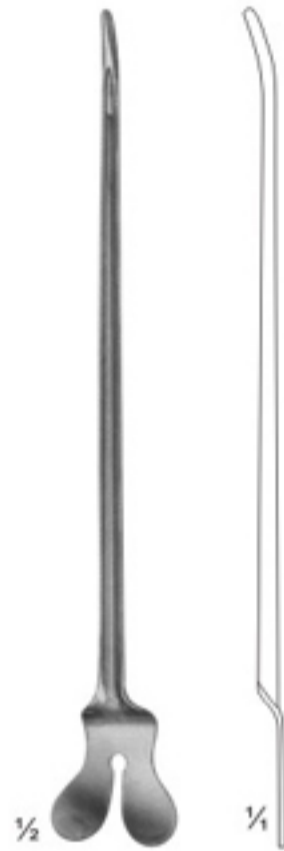

05-166
NELATON
 160 mm
 Directors



05-167
 Director with tip
 Diam. Of tip 3,3 mm
 140 mm

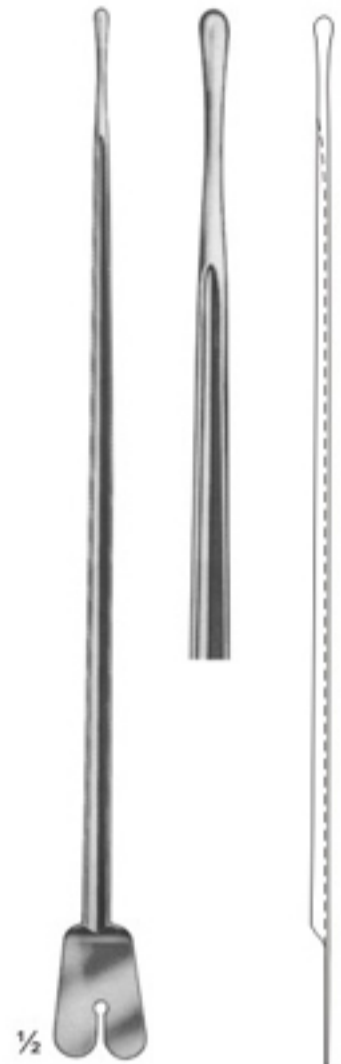

05-168
BRODIE
 Director with tip,
 Diam. Of tip 3,5 mm
 200 mm

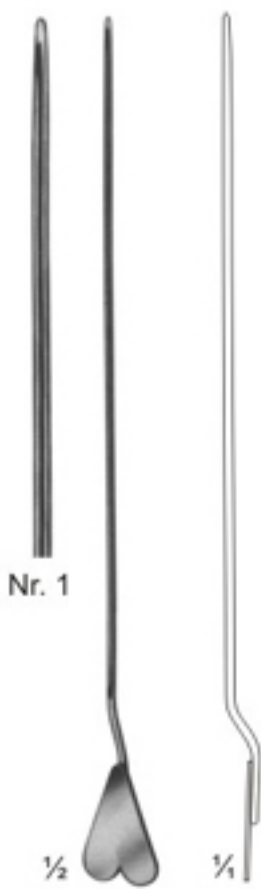

05-169
LOCKHART-MUMMERY
 165 mm

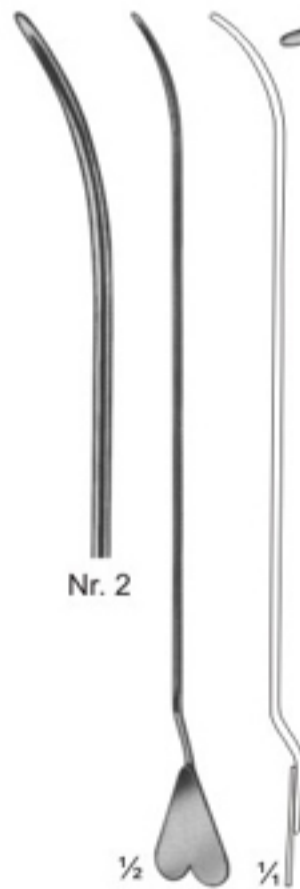

05-170
LOCKHART-MUMMERY
 165 mm

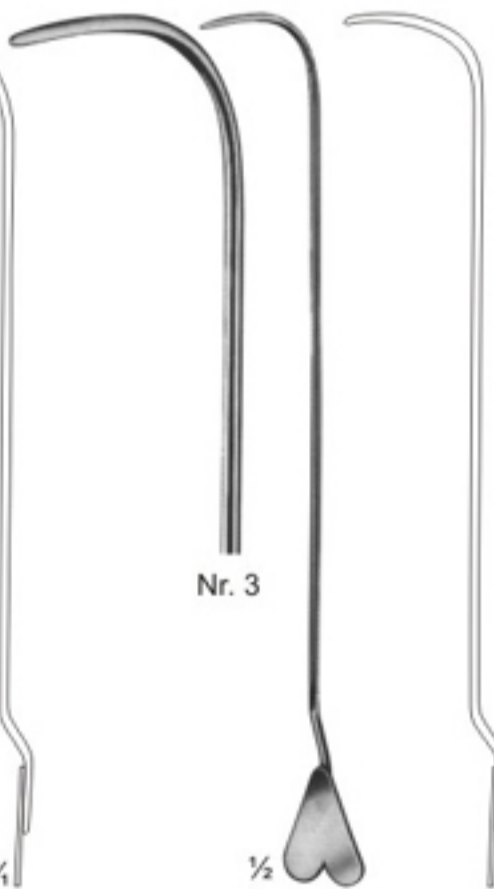

05-171
LOCKHART-MUMMERY
 165 mm

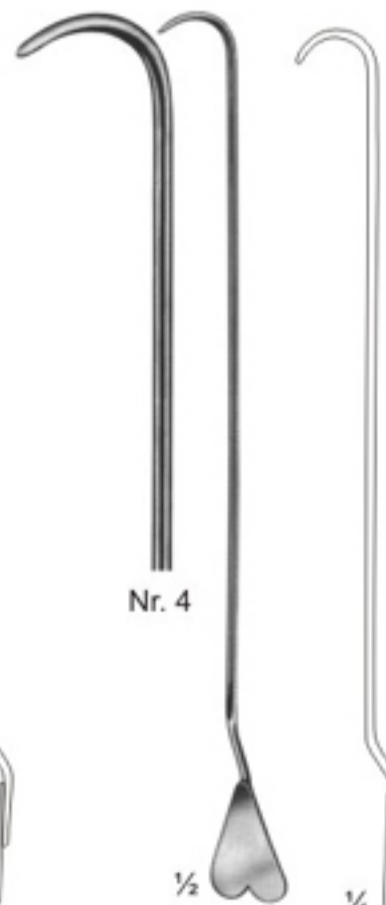

05-172
LOCKHART-MUMMERY
 165 mm



05-173
 Director with wire
 loop, malleable
 190 mm

Probes



05-174
2,5 mm
05-175
2,5 mm
05-176
3,0 mm

05-174 145 mm
05-175 160 mm
05-176 200 mm
Probes with eye



1,5 mm

05-177
Myrtle leaf probe
145 mm



2,0 mm

05-178 130 mm
05-179 145 mm
05-180 160 mm
05-181 180 mm
05-182 200 mm



05-183
Probes



05-184 1/2
Double ended probe,
malleable, diam. of tips
3 mm with hole
190 mm



05-185
Double ended probes,
tin, malleable,
diam. of tips
3,5 mm with hole
250 mm, 300 mm



05-186 1/4
Double ended probes,
tin, malleable,
diam. of tips 4 mm
400 mm



1/2 \varnothing tip
05-187 1,5 mm
05-188 2,0 mm
05-189 2,5 mm
300 mm

Suturing Instrument Set, Pocket Instrument Set



05-190

Suturing instruments set, in metal case consisting of: Scissors, curved, sharp/sharp, 115mm
 25 MICHEL clip, 16 x 3mm
 1 Delicate tissue forceps, 130mm
 1 Scalpel, bellied
 1 MATHIEU needle holder, 140mm
 1 Perforated metal case, stainless containing:
 1 Suture needle
 1 item 1 item



05-191

Pocket instrument set, in metal case consisting of:

Bottom tray

1 MATHIEU needle holder, 140mm
 1 MICHEL clip forceps, combined
 1 Myrtle leaf probe, 130mm
 1 Sharp double curette
 1 Skin hook
 1 Detachable scalpel handle, no.4
 1 Perforated metal case, containing
 6 Scalpel blades
 1 Perforated metal case, stainless, containing
 1 Suture needle
 1 item
 1 item



Top tray

1 Tissue forceps, 130mm
 1 KOCHER haemostatic forceps, 130mm
 1 Straight surgical scissors, 130mm
 1 Dissecting forceps, 130mm
 1 FEILCHENFELD splinter forceps, 115mm
 25 MICHEL clip, 16 x 3mm
 1 Flacon of suture skin, sterile in alcohol



05-192

Pocket instrument set, in metal case consisting of:

Bottom tray

1 MAYO-HEGER needle holder, 150mm
 1 MICHEL clip forceps, combined
 1 Myrtle leaf probe, 130mm
 1 Sharp double curette
 1 Skin hook
 1 Detachable scalpel handle, no. 4
 1 Perforated metal case, consisting
 6 Scalpel blades
 1 Perforated metal case, stainless, consisting:
 1 Suture needle
 1 item, & 1 item

Top tray

1 Tissue forceps, 130mm
 1 CRILE haemostatic forceps, 140mm
 1 Straight surgical scissors, 130mm
 1 Dissecting forceps, 130mm
 1 FEILCHENFELD splinter forceps, 115mm
 25 MICHEL clip, 16 x 3mm
 1 Flacon of suture silk, sterile in alcohol

Fine Wound Retractors (Dura- and Skin Retractors)

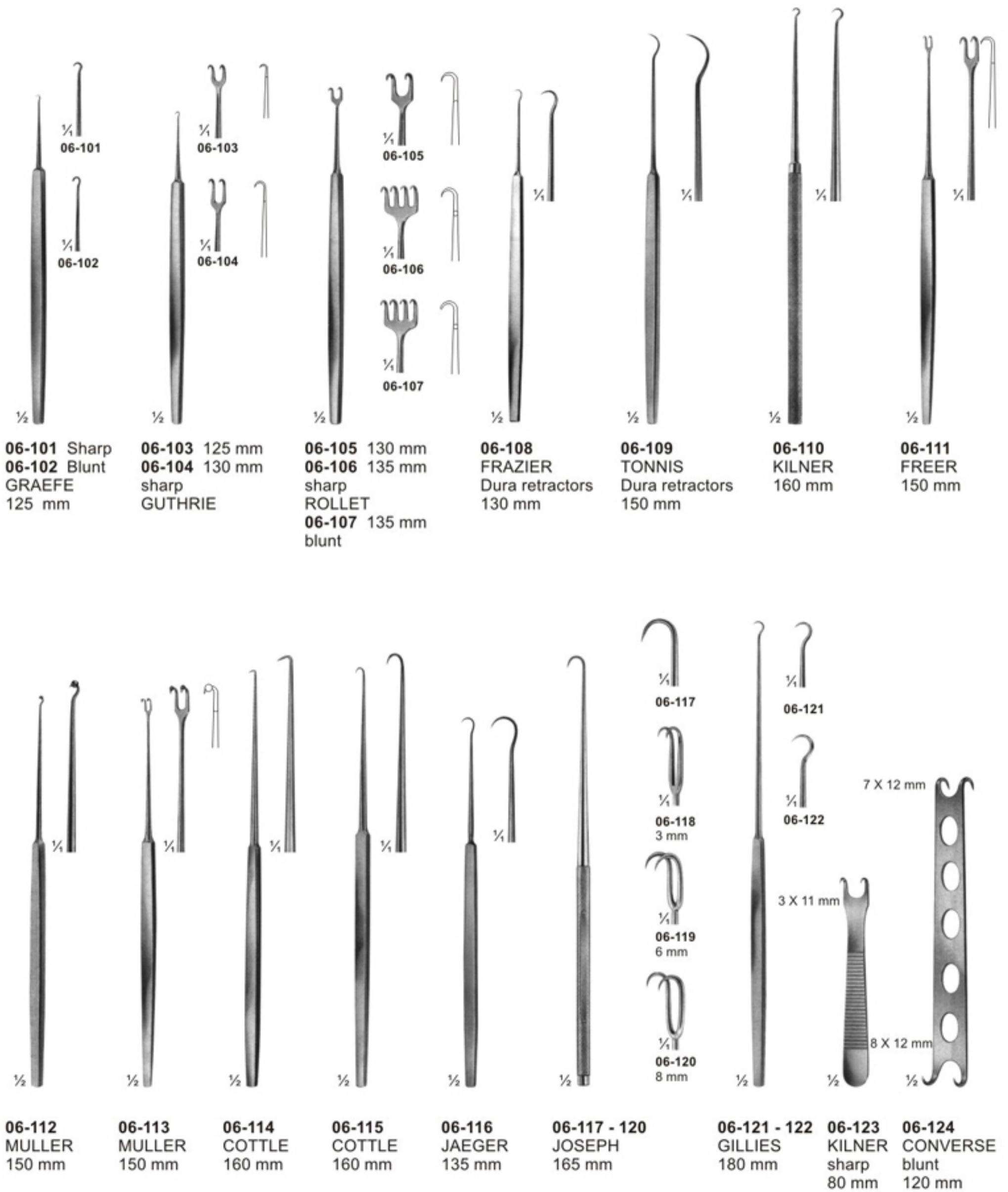

Retractors With treangle handle

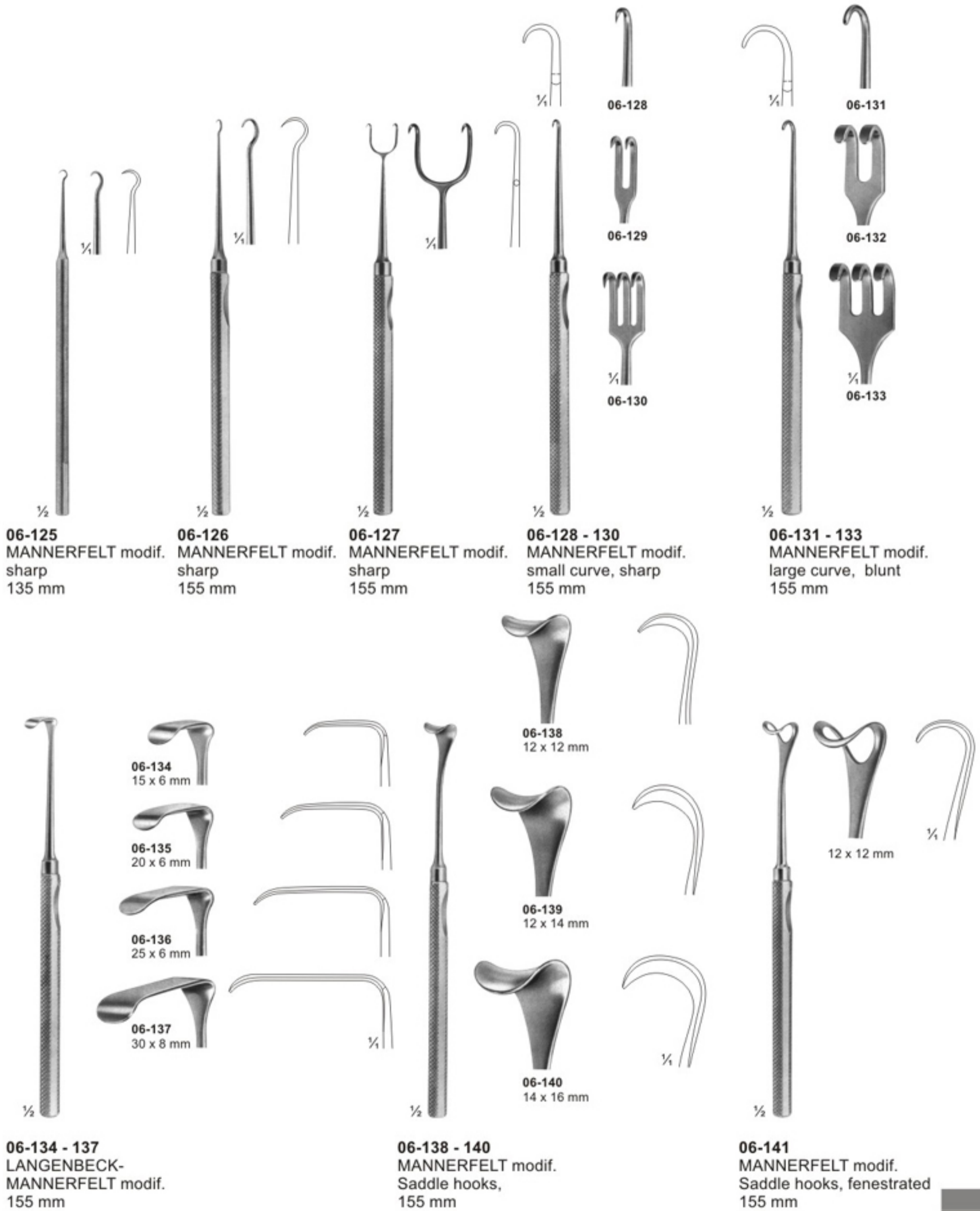

Retractors

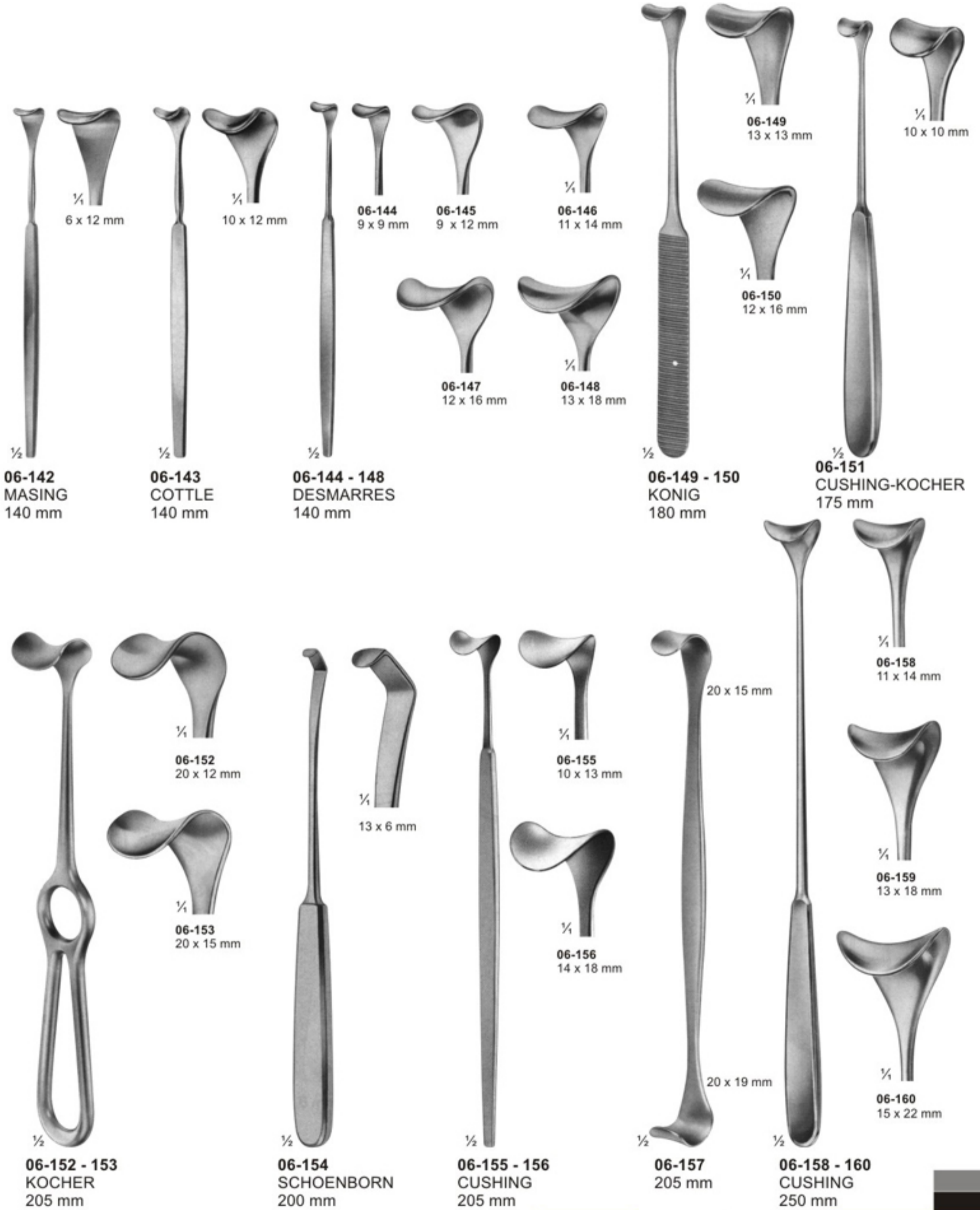

Retractors



Retractors

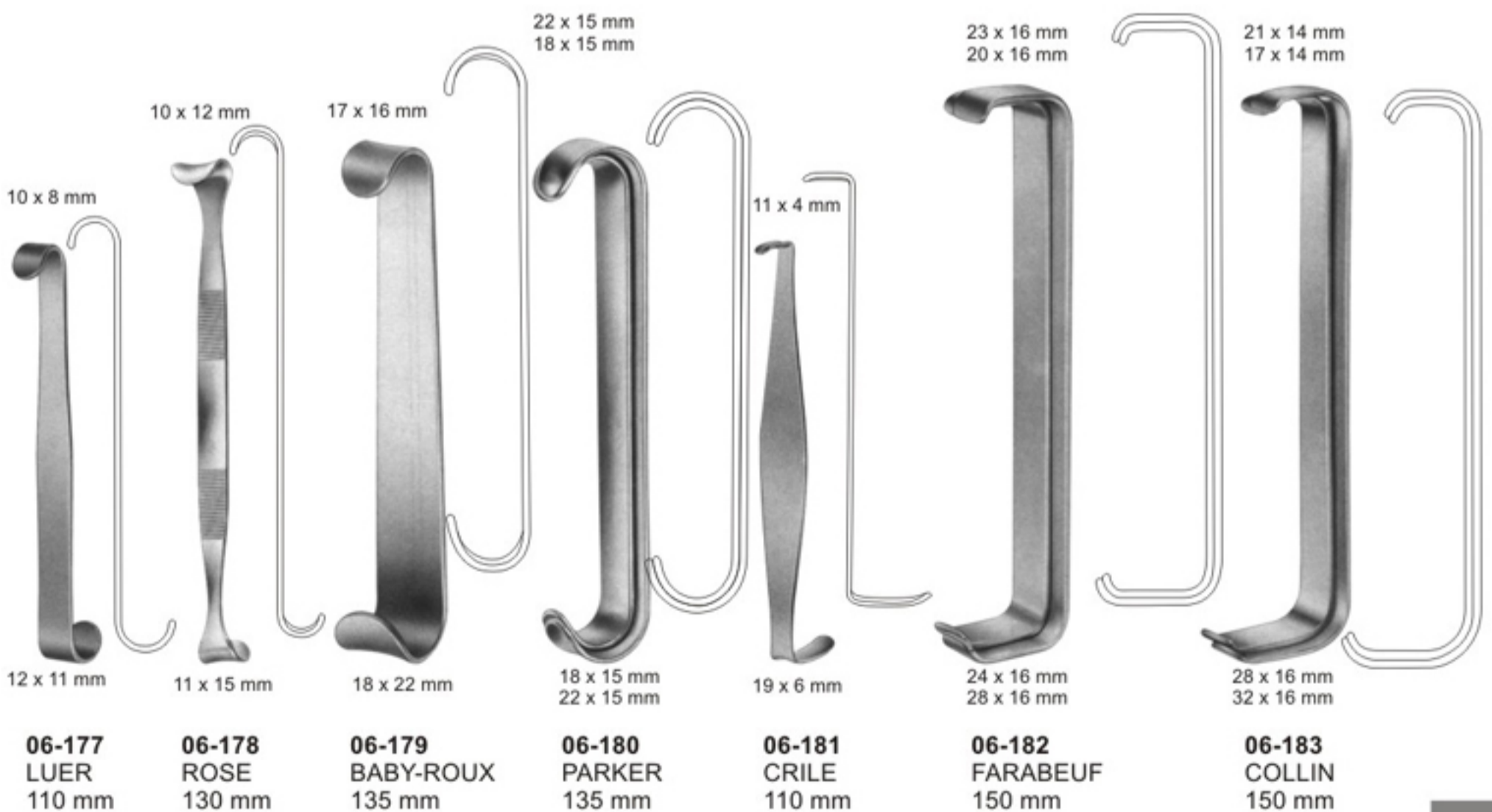
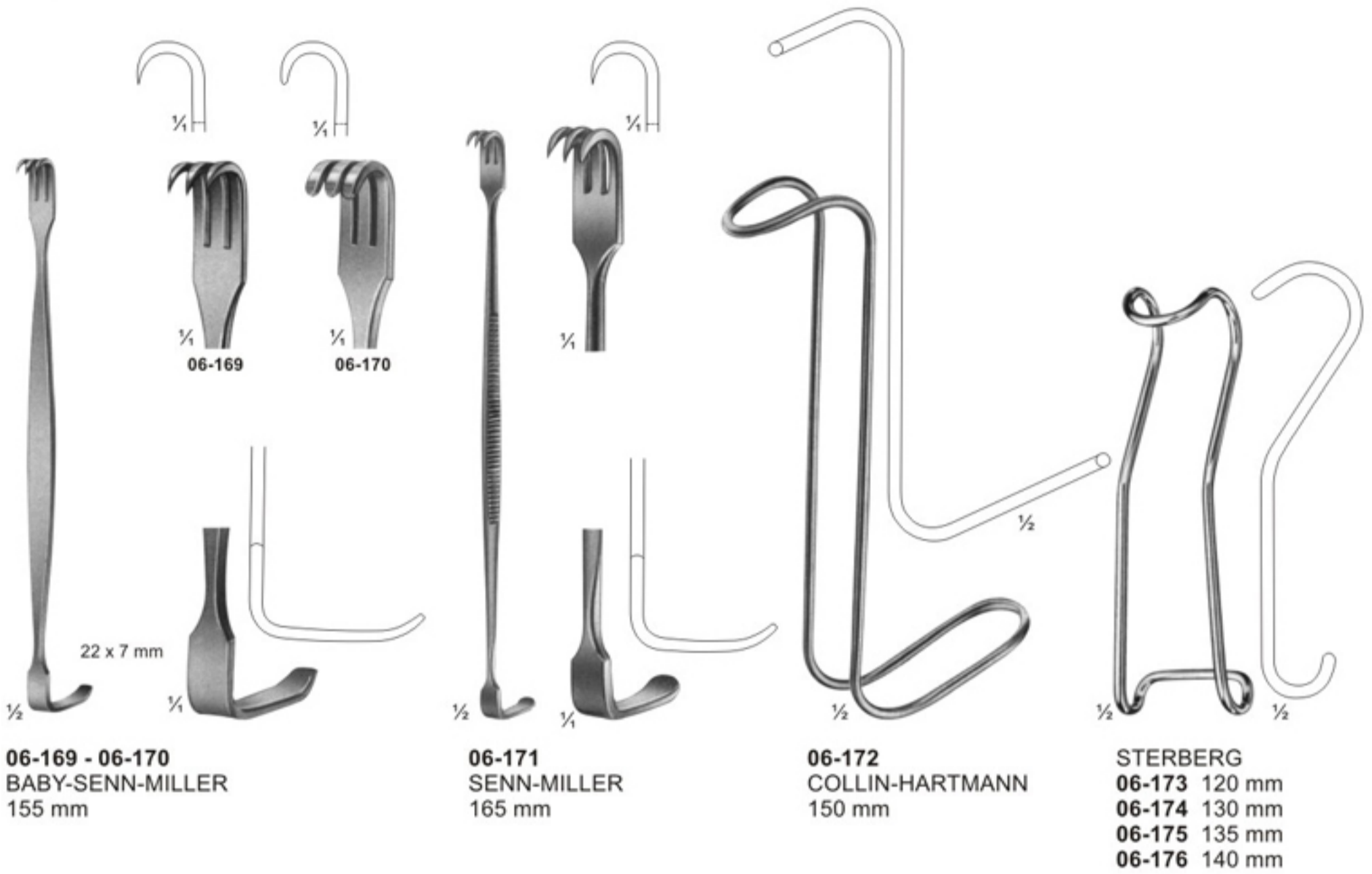

Bone Retractors and Retractors



06-184
KOCHER
sharp
205 mm



06-185
KOCHER
sharp
220 mm



06-186
KOCHER
sharp
220 mm



06-187
VOLKMANN
blunt
220 mm



06-188
VOLKMANN
sharp
220 mm



06-189 - 06-196
VOLKMANN
225 mm



06-189
9 x 8 mm



06-190
9 x 13 mm



06-191
9 x 19 mm



06-192
9 x 29 mm

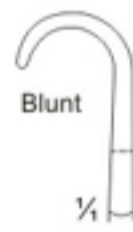

06-193
8,5 x 8 mm



06-194
8,5 x 13 mm



06-195
8,5 x 19 mm



06-196
8,5 x 29 mm

Retractors



1/2
06-197 - 06-199
MIDDELDORPF



1/2
06-197
15 x 15 mm
220 mm



1/2
06-198
20 x 22 mm
215 mm



1/2
06-199
28 x 28 mm
235 mm



1/4



1/4

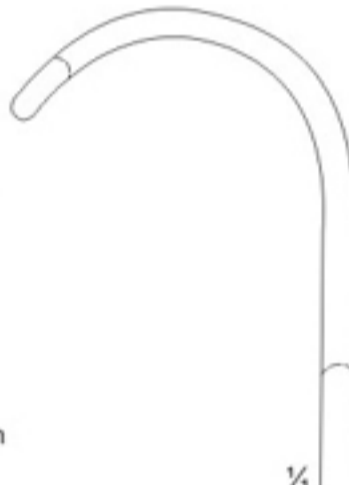

1/4



1/2
06-200
BUCHS
205 mm



38 x 18 mm

1/4



1/2
06-202
KOCHER
230 mm

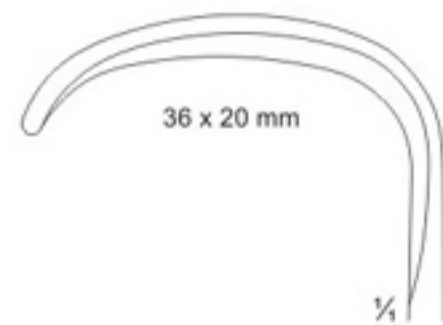

36 x 20 mm

1/4



67 x 17 mm

1/4



1/2
06-201
CASPAR
210 mm

Retractors, Vario Retractor System



- 06-203- 06-209**
BRUNNER
275 mm
- | | |
|---------------|----------|
| 06-203 | 80 x 20 |
| 06-204 | 100 x 25 |
| 06-205 | 120 x 25 |
| 06-206 | 130 x 30 |
| 06-207 | 140 x 30 |
| 06-208 | 160 x 30 |
| 06-209 | 180 x 30 |

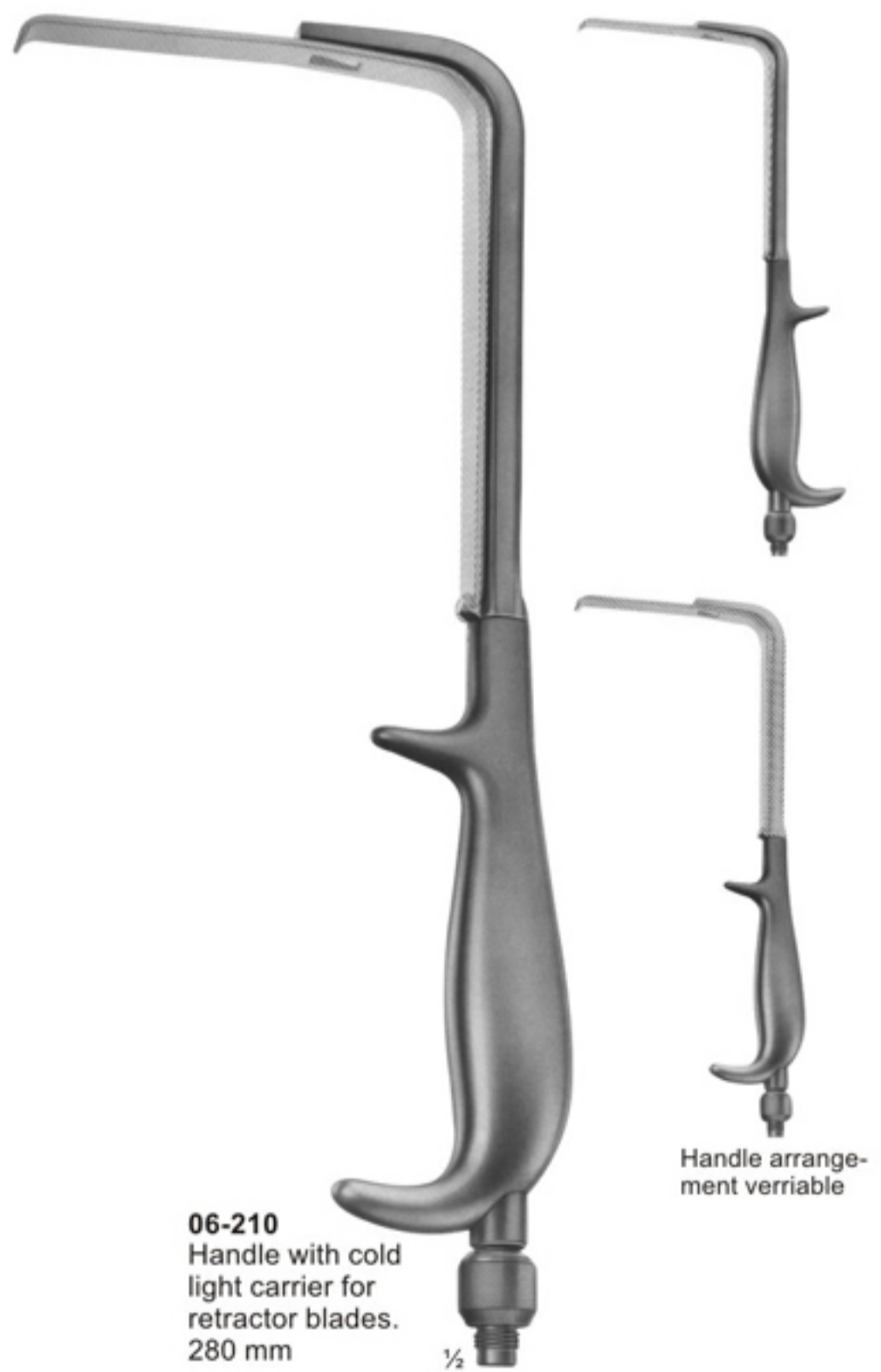

- 06-210**
Handle with cold
light carrier for
retractor blades.
280 mm

Retractors, Lung Spatulas



**Retractors for deep surgery
(Abdominal Retractors)**

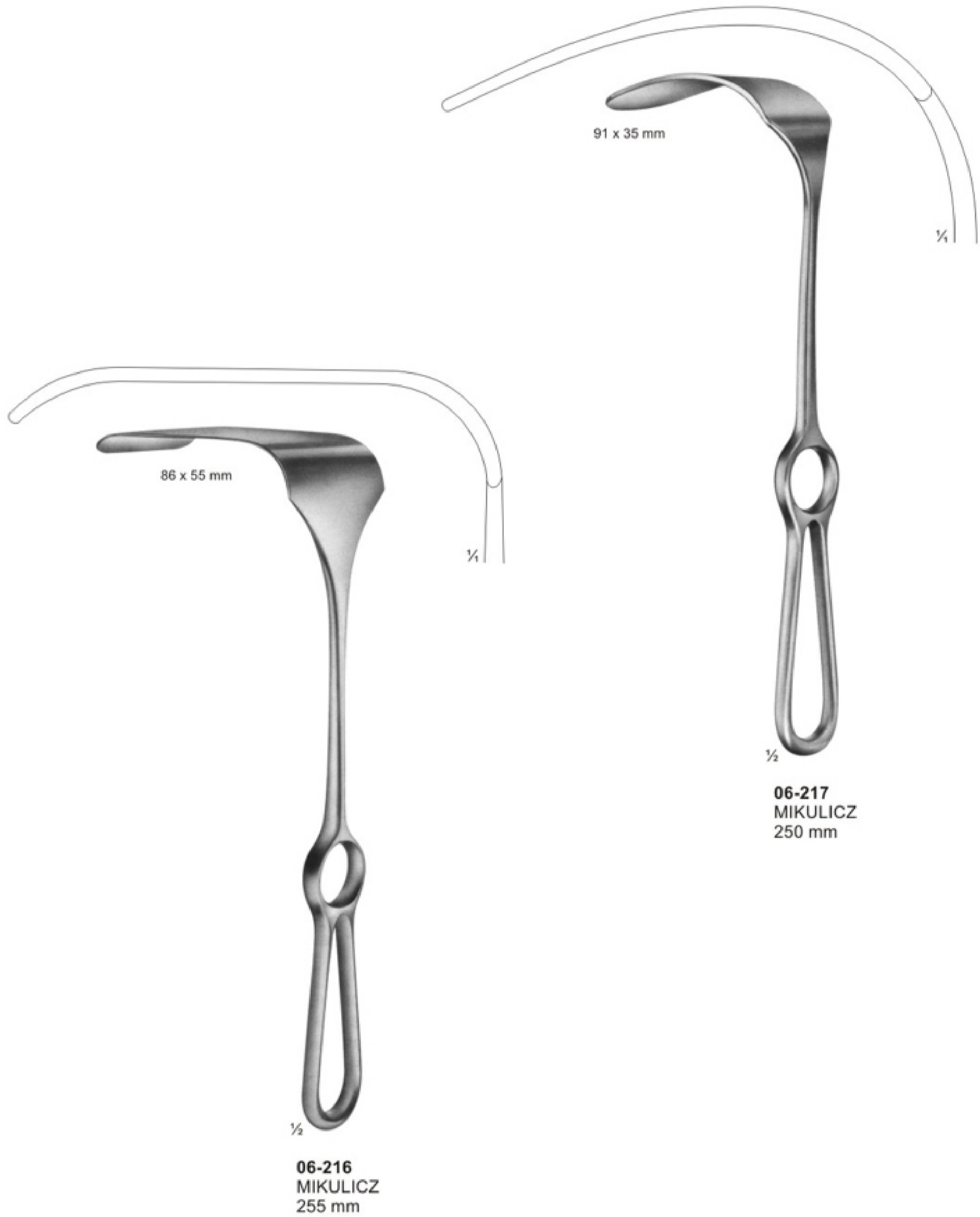

Retractors, Abdominal Retractors



- 06-229 Fig.1 32 x 40 mm
- 06-230 Fig.2 34 x 50 mm
- 06-231 Fig.3 41 x 60 mm
- 06-232 Fig.4 46 x 75 mm
- 06-233 Fig.5 64 x 85 mm

06-218 - 06-228
DOYEN
240 mm

06-229 - 06-233
FRITSCH
240 mm

06-234
DOYEN
250 mm

	width of blades	
	35 mm, 45 mm, 60 mm	
length of blades		
62 mm	06-218, 06-222, 06-226	
92 mm	06-219, 06-223, 06-227	
122 mm	06-220, 06-224, 06-228	
160 mm	06-221, 06-225	

Abdominal- and Intestinal Spatulas
Bauch- und Darmspatel



06-235
LERICHE
255 mm

06-236
KUMMEL
Mealleable
285 mm

06-237
MIKULICZ
29 mm
250 mm

06-238 - 06-239
KADER
06-238 30 mm
06-239 40 mm
270 mm

Self-Retaining Retractors

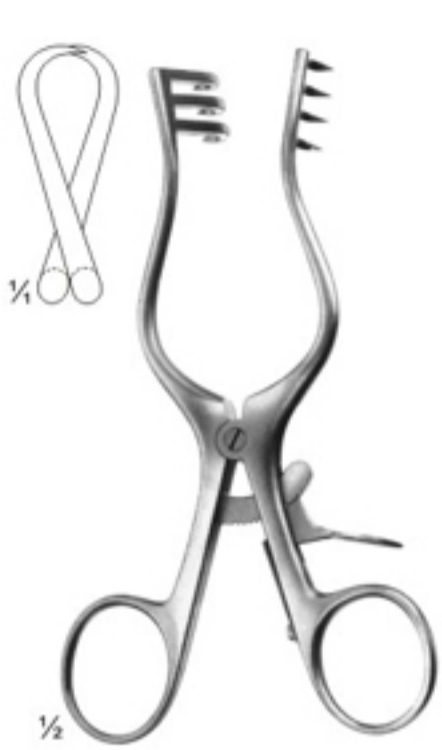

06-240
WEITLANER
sharp
130 mm

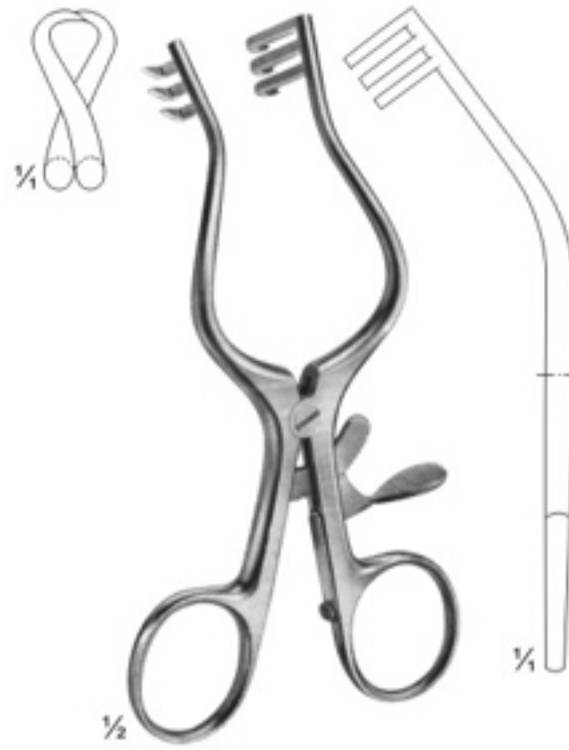

06-241
WULLSTEIN
sharp
130 mm

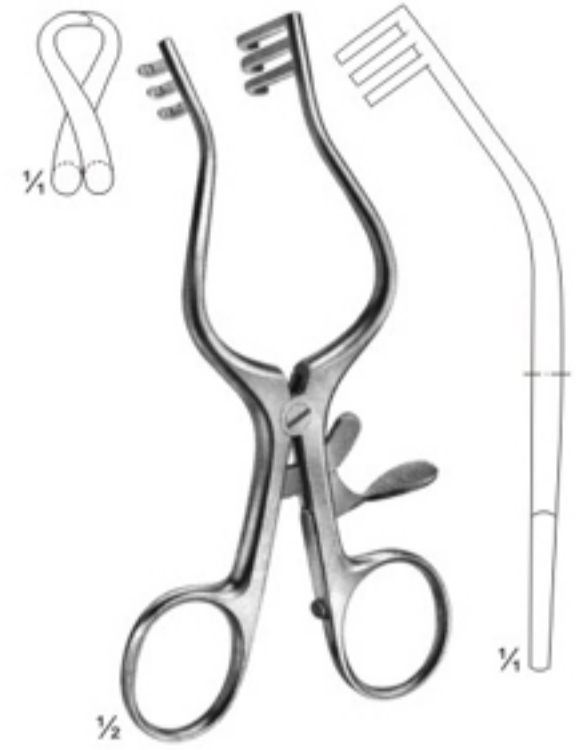

06-242
WULLSTEIN
blunt
130 mm

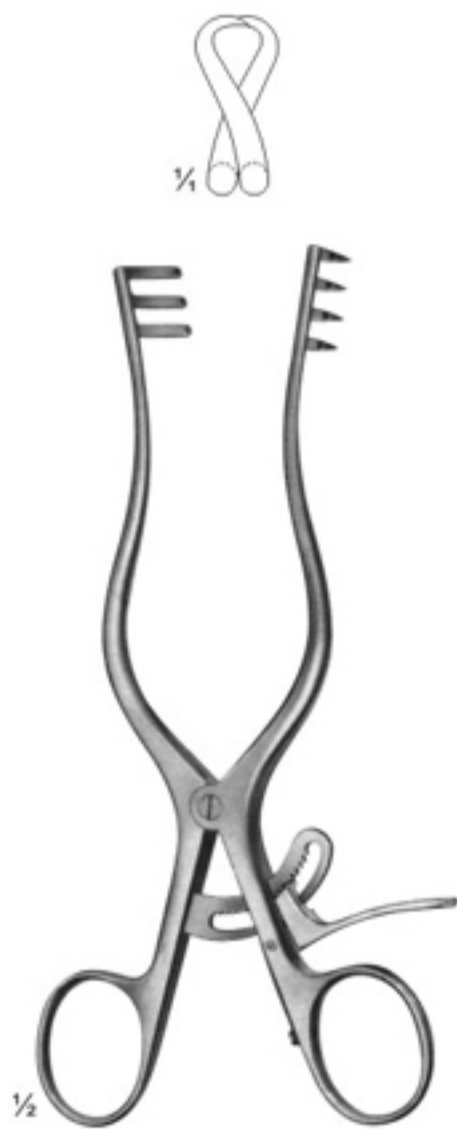

06-243
WEITLANER
sharp
165 mm



06-244
PLESTER
blunt
110 mm

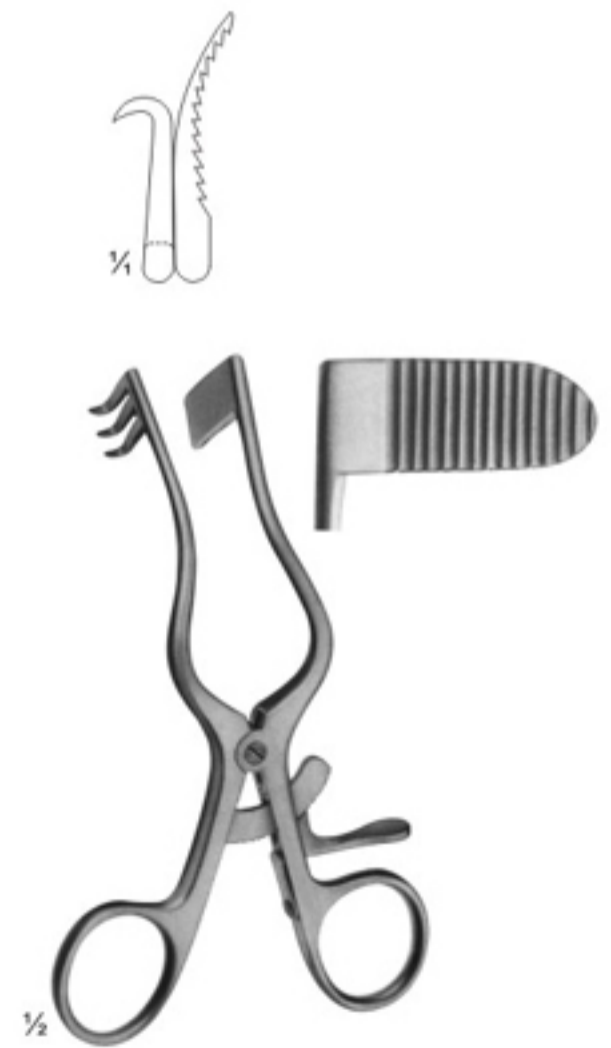

06-245
PERKINS
blunt
130 mm

Special Retractors



06-246
JOLL (FRIEDMAN)
Thyroid- and vaginal retractor
155 mm

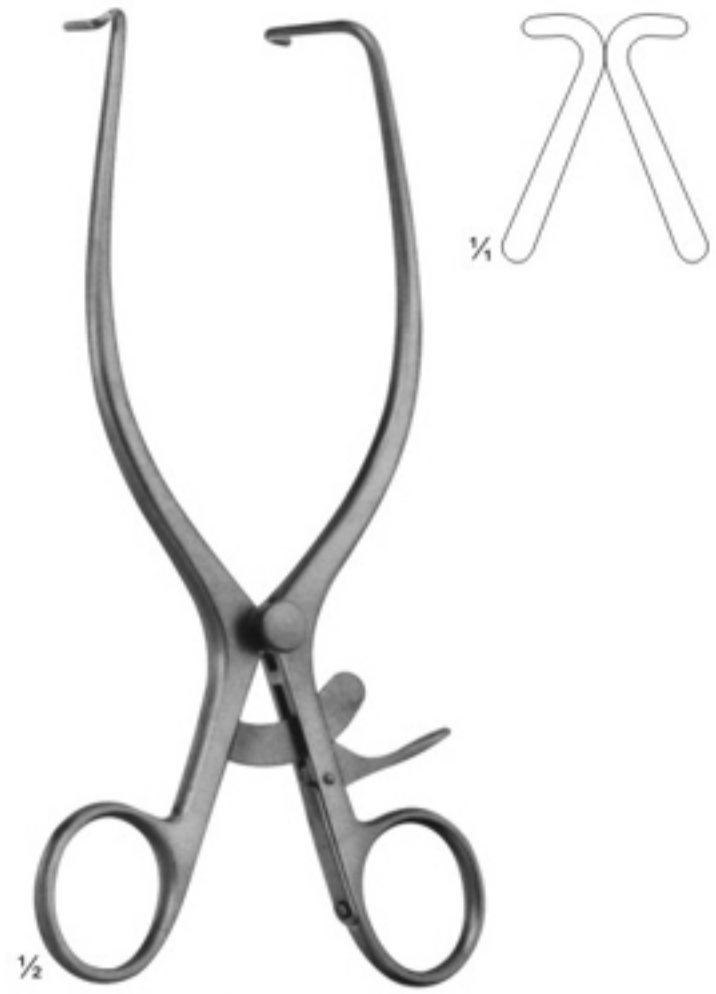

06-247
JACKSON BURROWS
Retractor, blunt
185 mm



06-248
GELPI
Vaginal retractor
135 mm



06-249
GELPI
Skin- and vaginal retractor
175 mm



06-250
DE BAKEY
Femur retractor
145 mm

Lamina Spreaders



06-251
CLOWARD
155 mm



06-252
CLOWARD
135 mm



06-253
INGE
170 mm

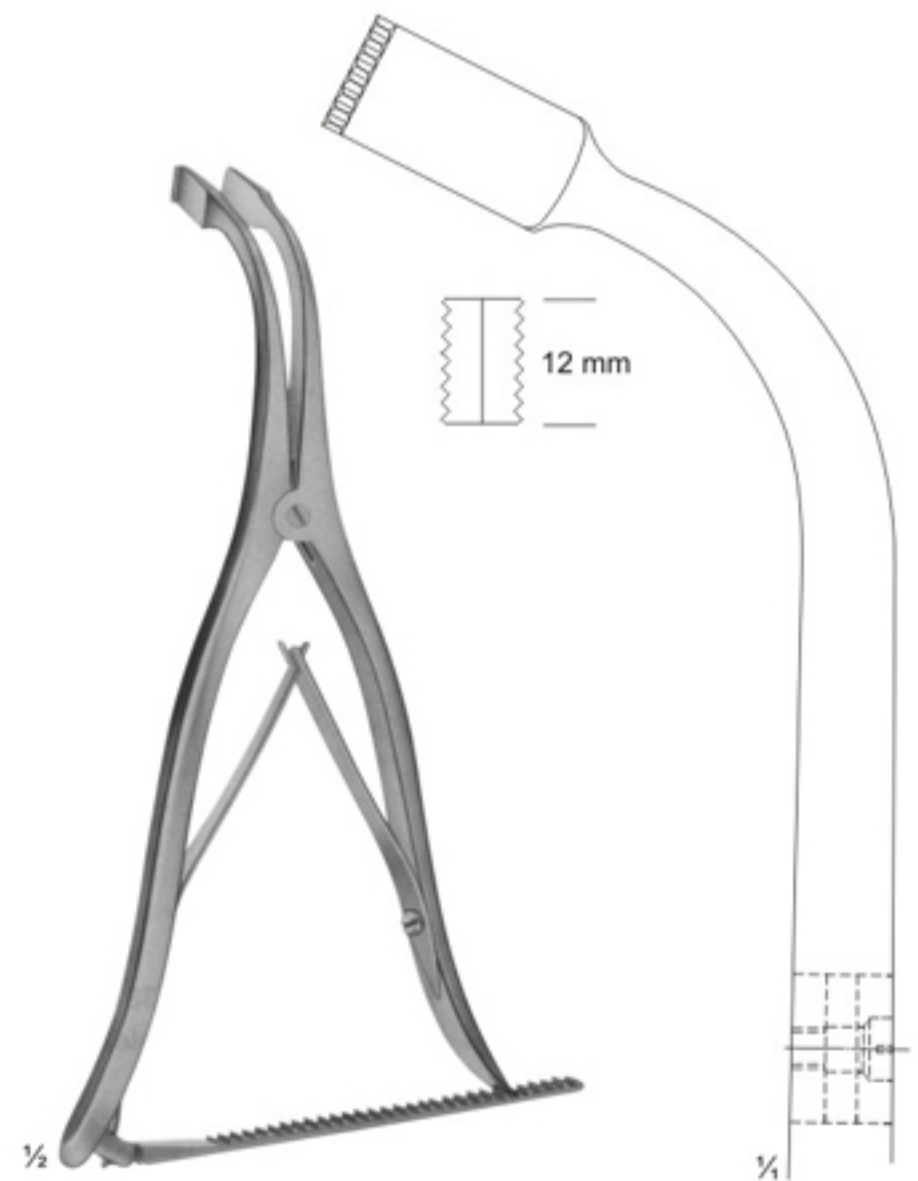

06-254
INGE
275 mm

Abdominal Retractors



06-255
GOSSET
Blades: 38 mm deep

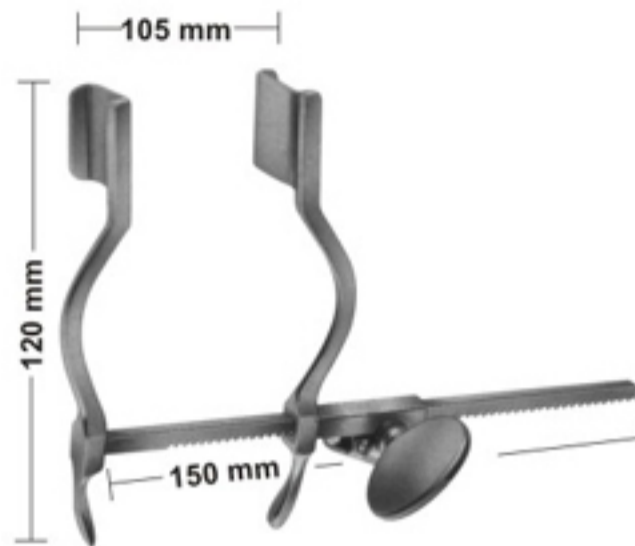

06-256
HERTZLER
Blades 20 X 25 mm

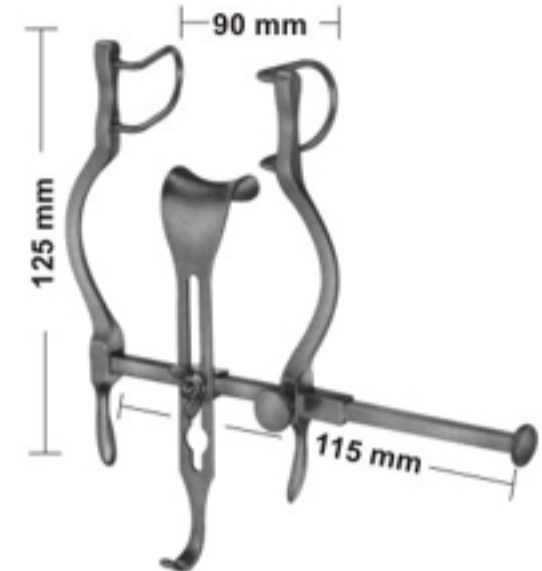

06-257
BALFOUR-BABY
Lateral blades 27 mm deep
Center blade 21x24 mm

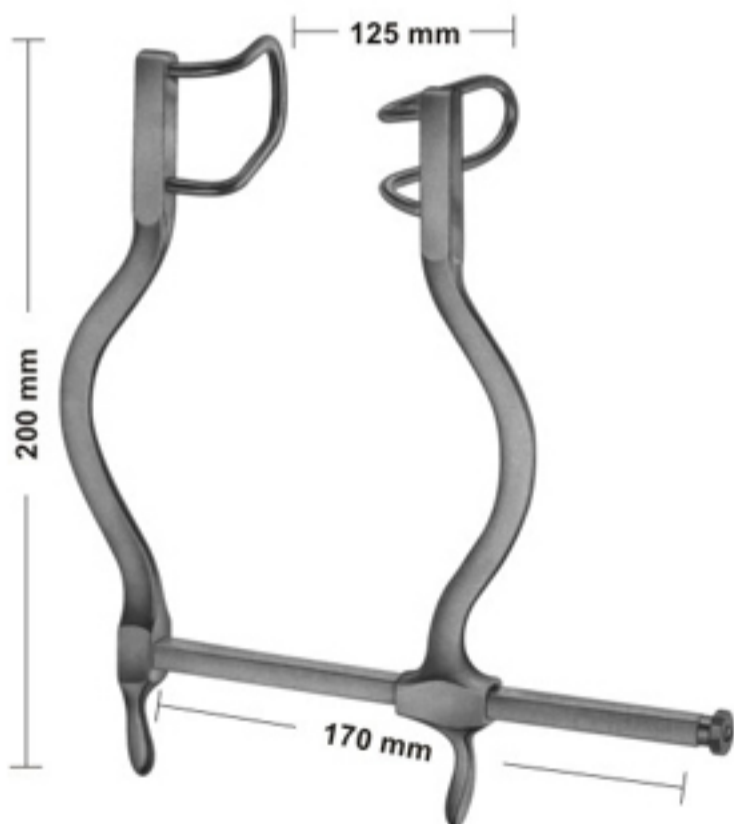

06-258
GOSSET
Blades: 55 mm deep

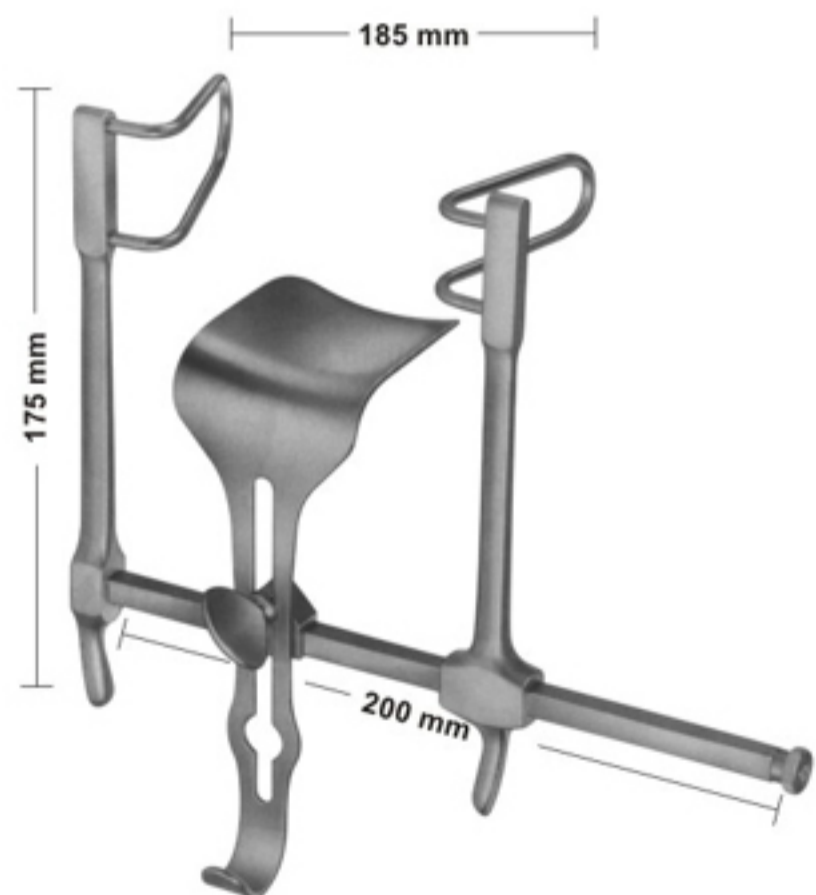

06-259
GOSSET
Lateral blades 58 mm deep
Center blade 59 x 57 mm

Abdominal Retractors

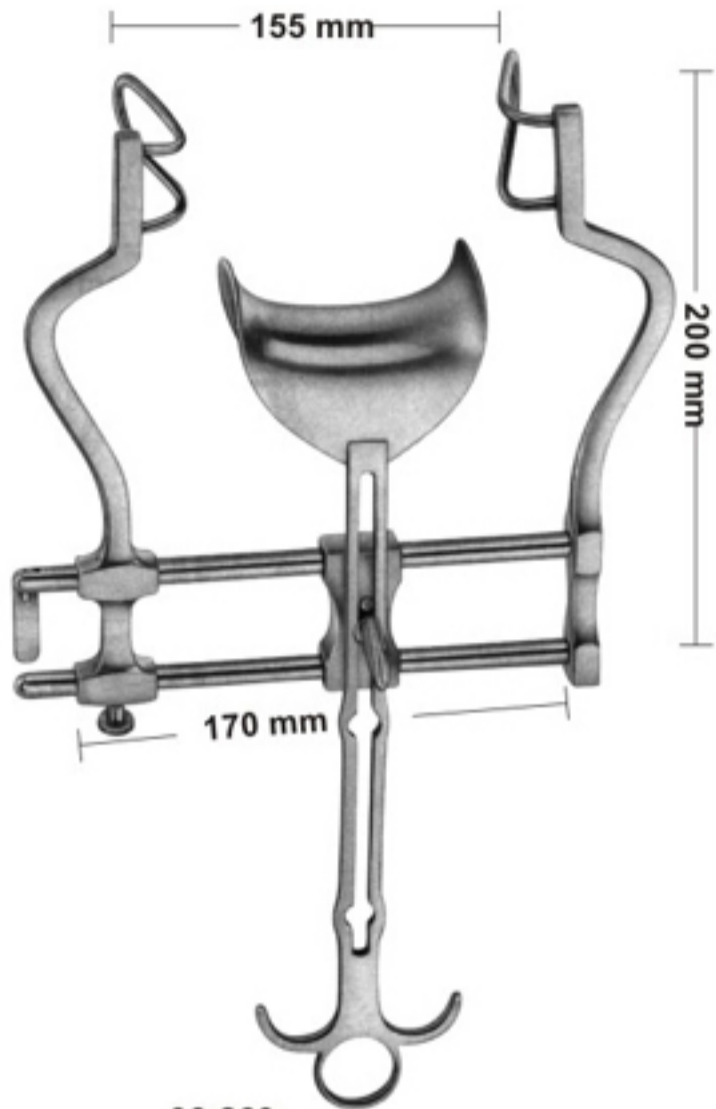

06-260
BALFOUR
 Lateral blades 60 mm deep
 Center blade 47 x 80 mm

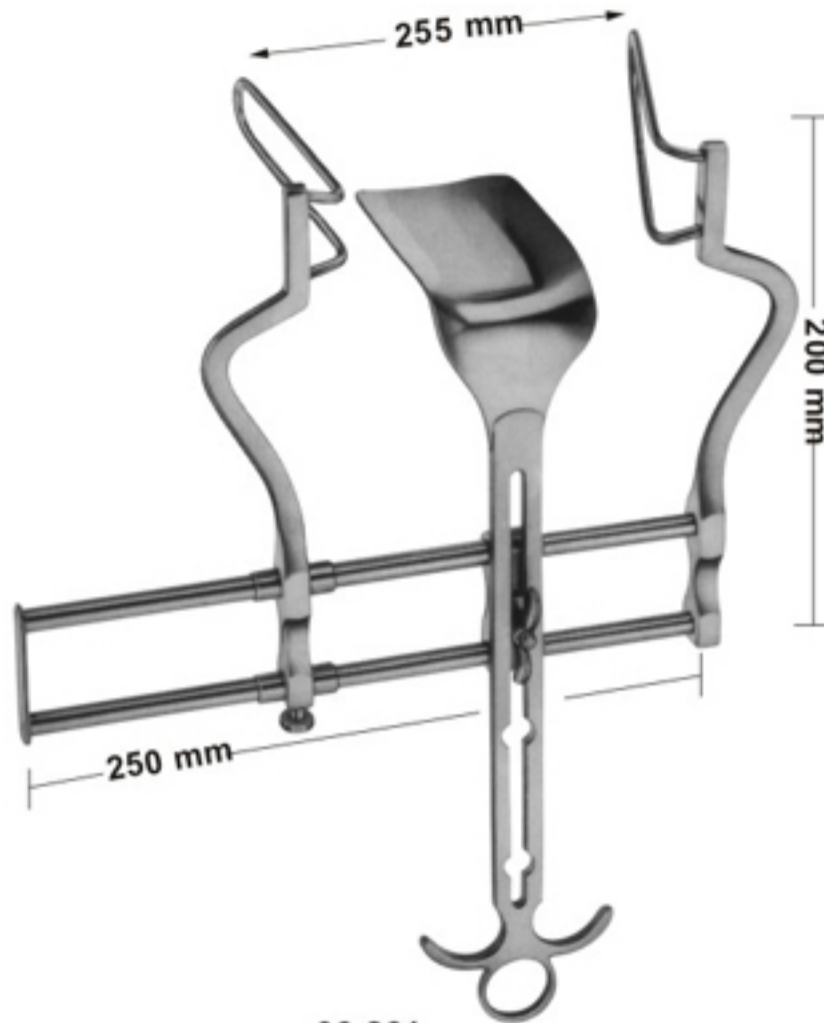

06-261
BALFOUR
 Lateral blades 105 mm deep
 Center blade 107x 59 mm



06-262
 Center blade only
 54x80 mm

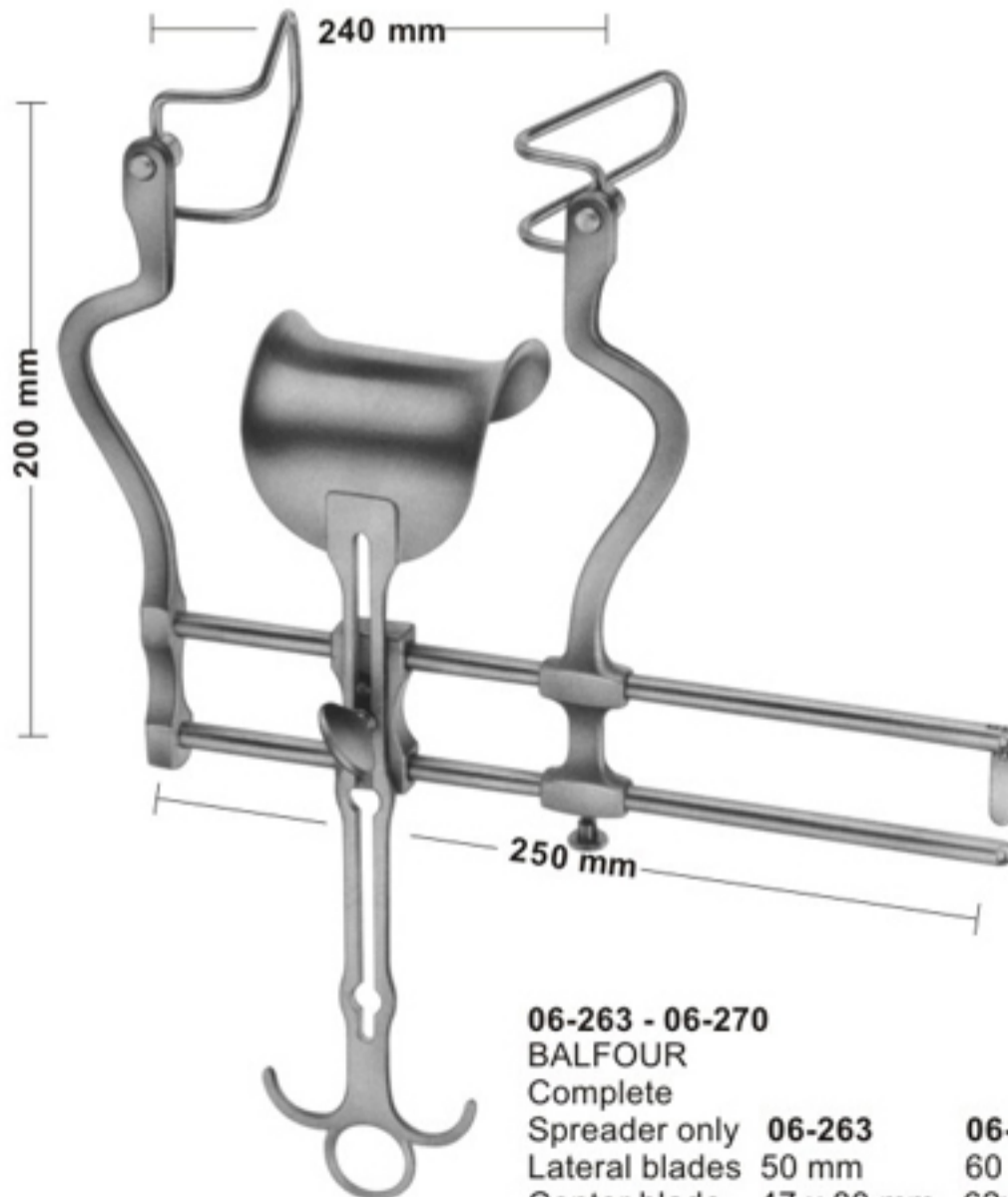

06-263 - 06-270
BALFOUR
 Complete
 Spreader only

06-263	06-264	06-265	06-266
Lateral blades 50 mm	60 mm	75 mm	90 mm
Center blade 47 x 80 mm	62x76 mm	80x80 mm	80x80 mm



Lateral blades
06-267 50 mm deep
06-268 60 mm deep
06-269 75 mm deep
06-270 90 mm deep
 Sales Unit of blades:PR = pair

Organ-, Tissue and Intestinal Grasping Forceps

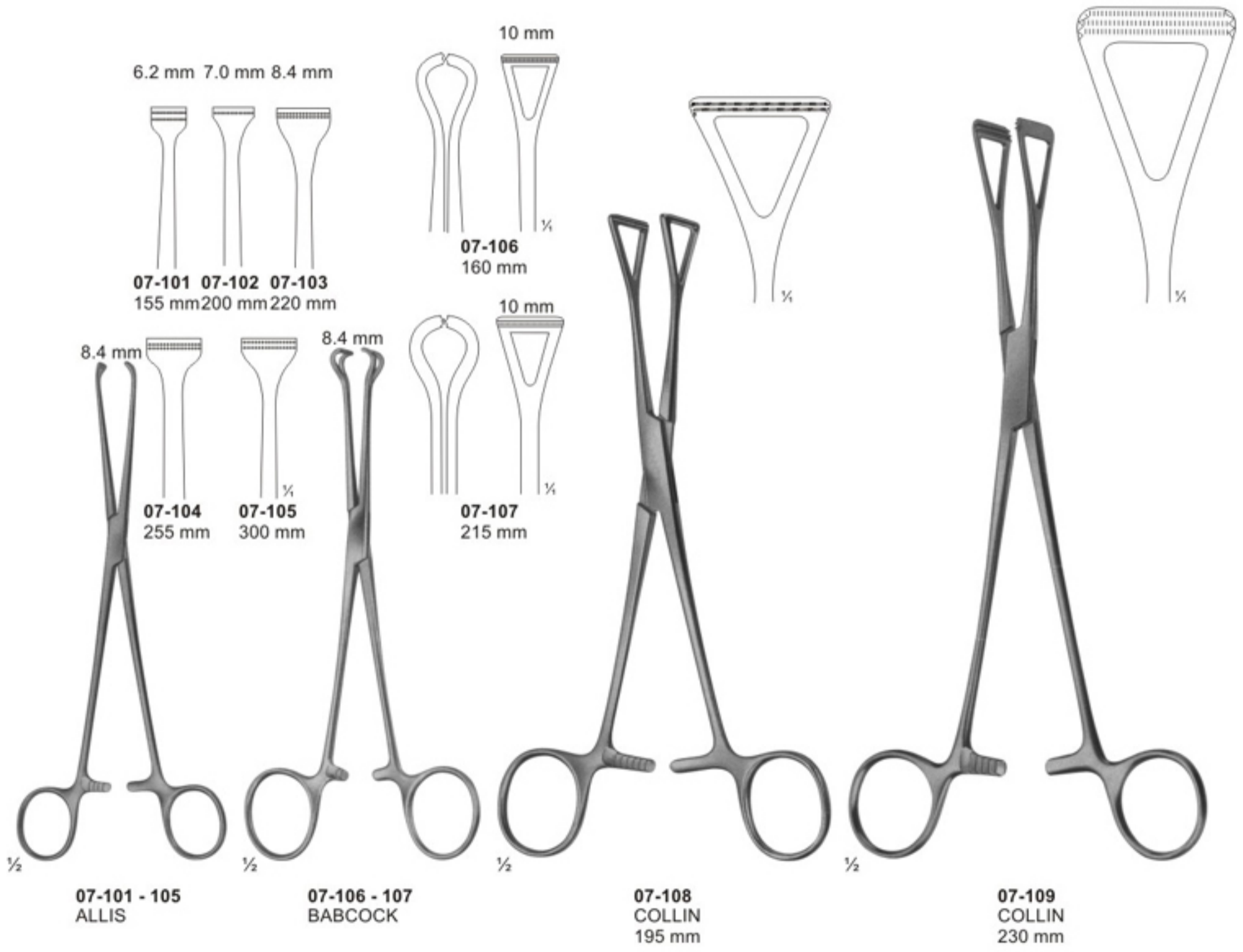

Intestinal Clamps, soft elastic

ATRAUMATA

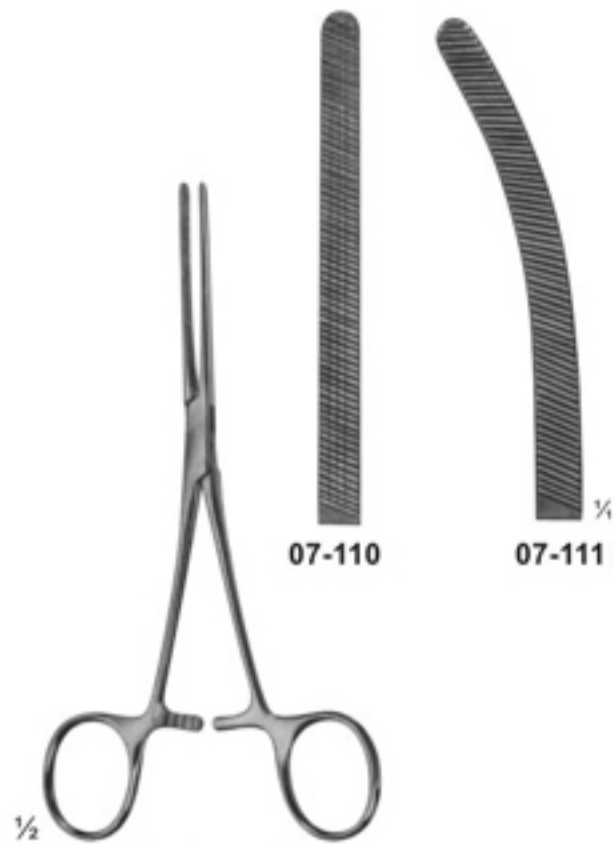

07-110 - 111
DOYEN
elastic
165 mm

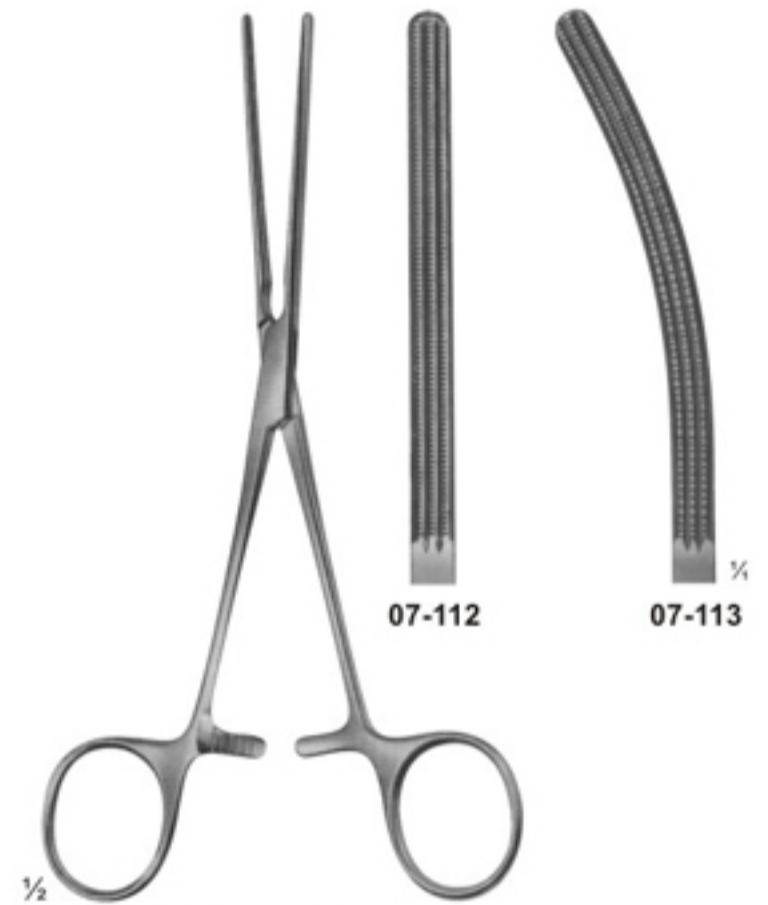

07-112 - 113
DOYEN
with elastic blades
170 mm

ATRAUMATA

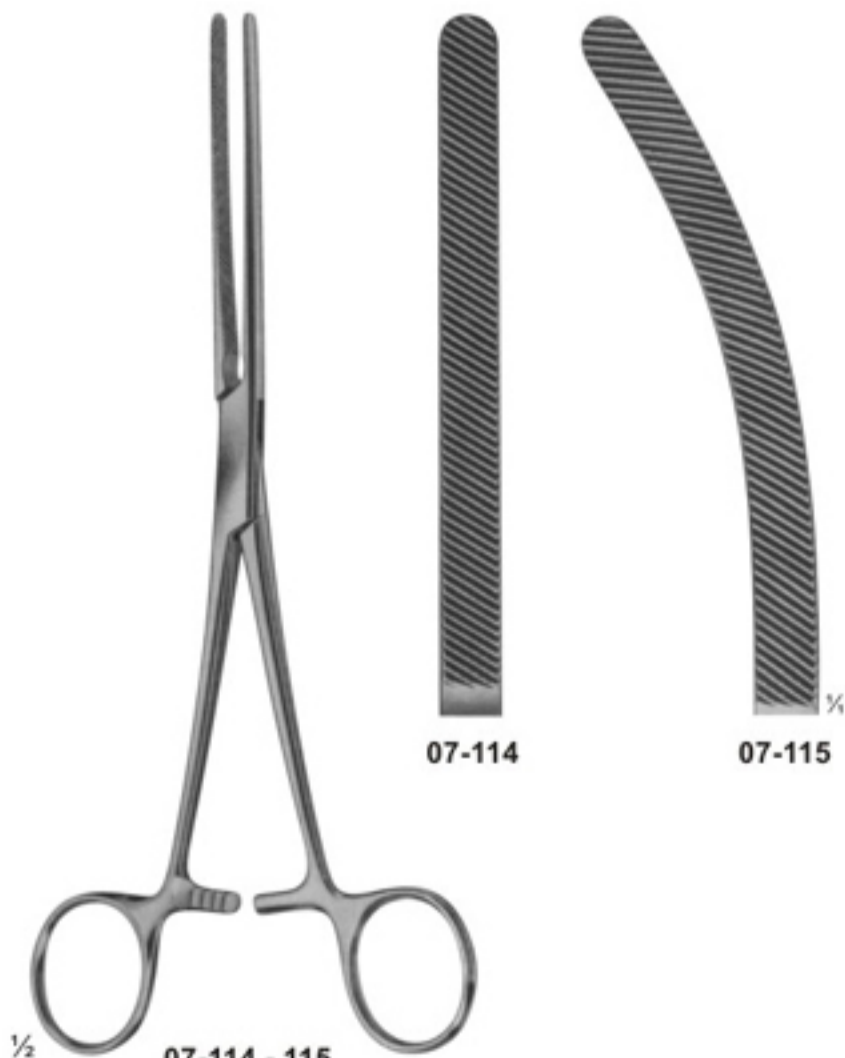

07-114 - 115
HARTMANN
with elastic blades
200 mm

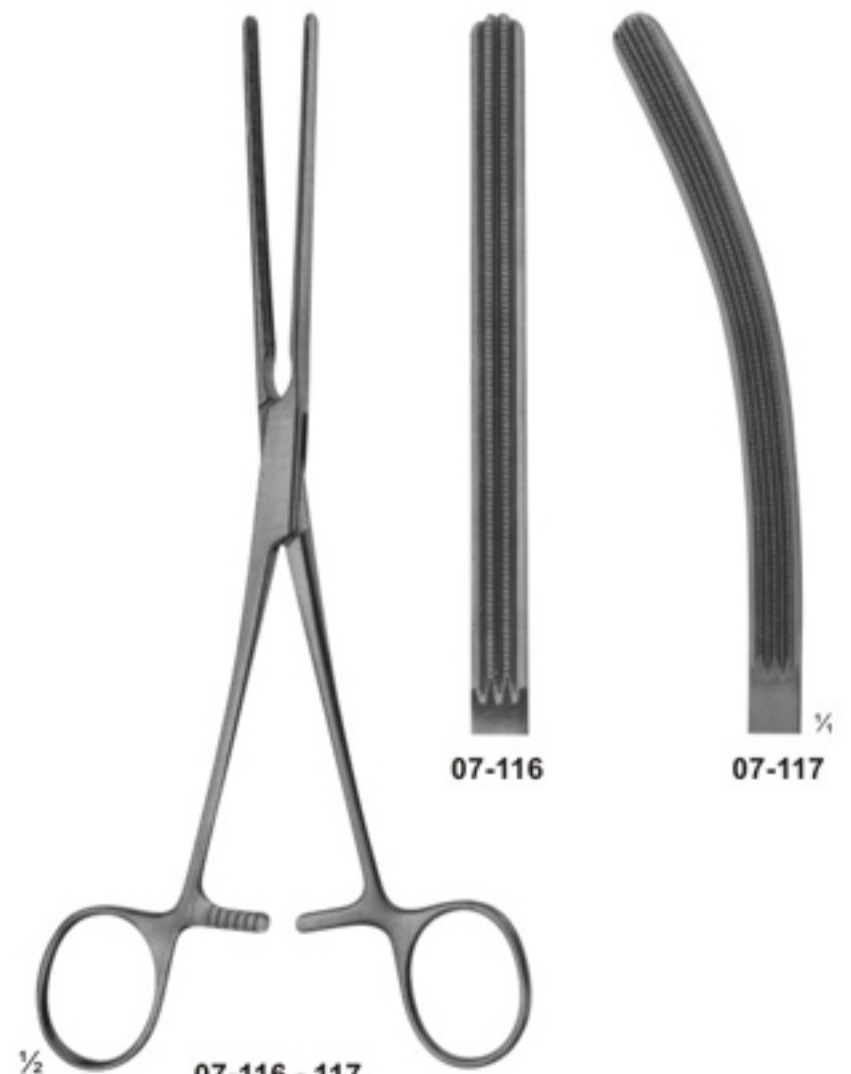

07-116 - 117
HARTMANN
with elastic blades
200 mm

Intestinal and Pylorus Clamps



½

07-118
PAYR
Intestinal clamp
light pattern,
for children
180 mm

½

07-119
PAYR
200 mm

½

07-120
PAYR
275 mm

½

07-121
PAYR
Pylorus clamp
315 mm

ATRAUMATA
Sigmoid Anastomosis Forceps

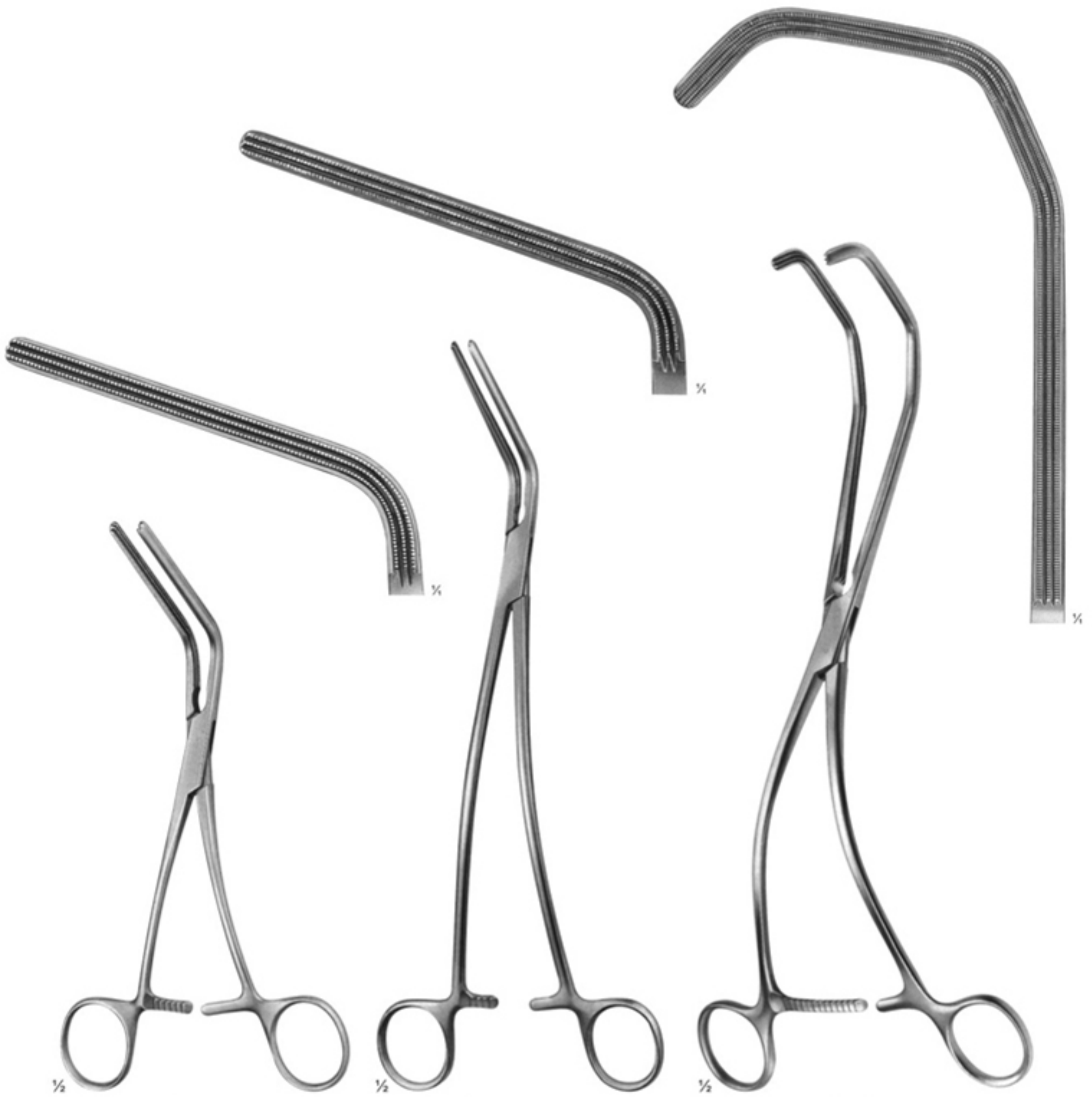

07-122
MORRIS
175 mm

07-123
DE BAKEY
(MORRIS modif.)
240 mm

07-124
KERSTING
270 mm

Nasal Specula



08-101
Martin
13 cm / 5 1/8"



08-102
SIMS
160 mm

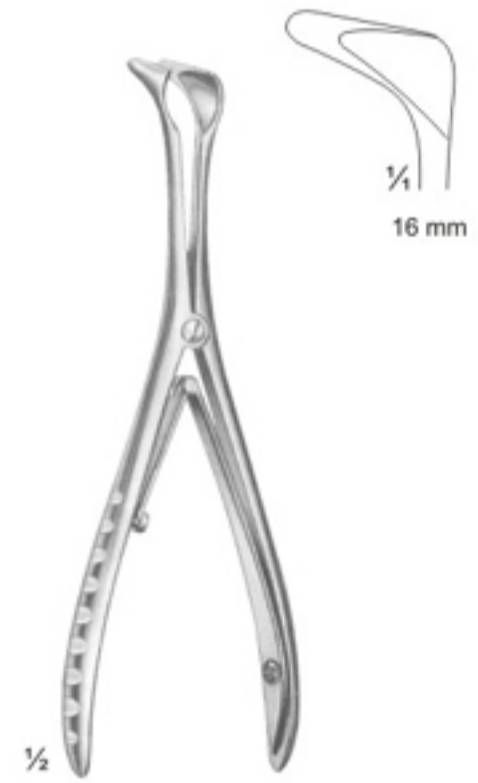

08-103
Tieck-Halle
13 cm / 5 1/8"



08-104
Killian

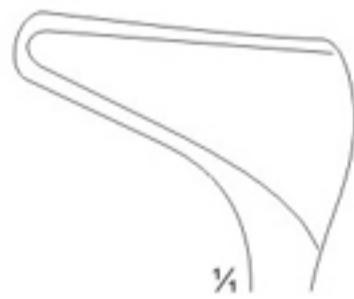

Fig. 1
14 cm 5 4/8"
35 mm

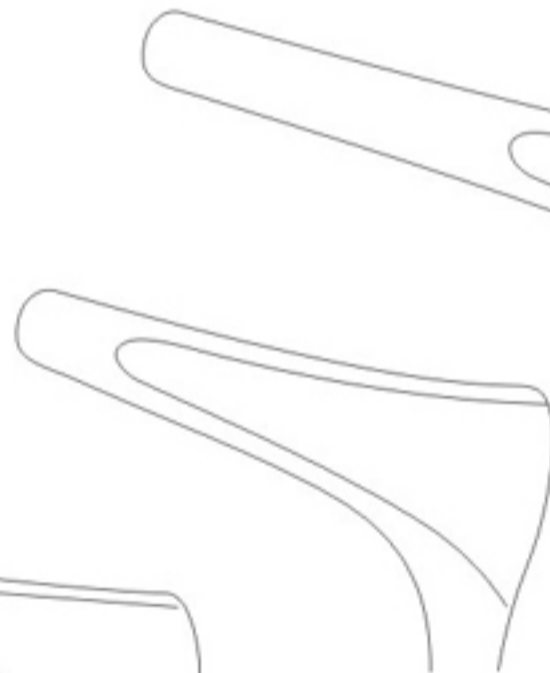

Fig. 2
14,5 cm / 5 4/8"
50 mm

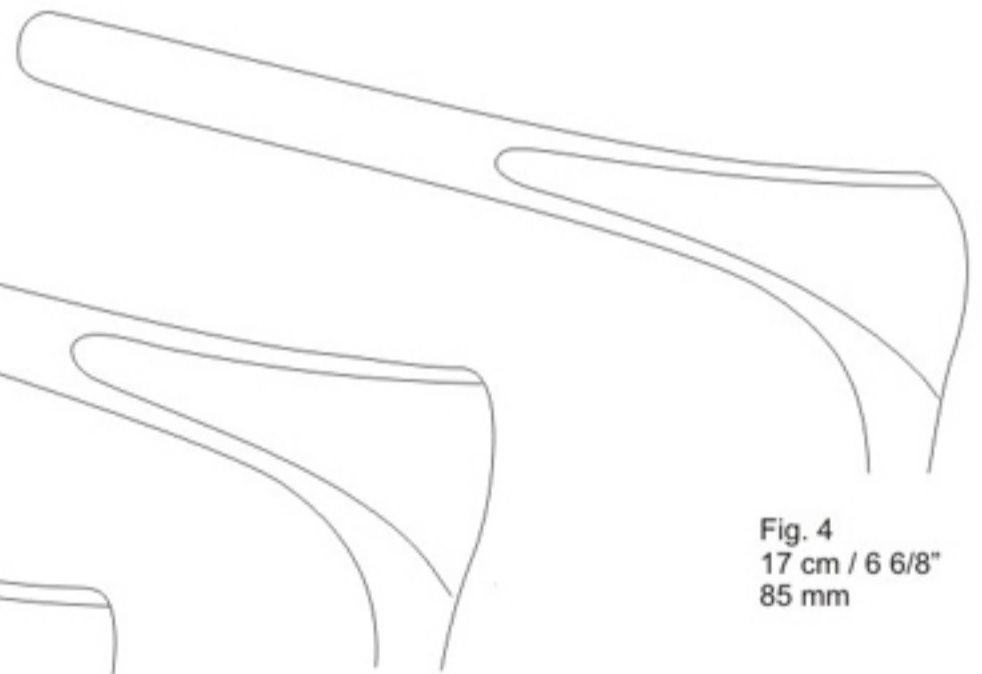

Fig. 3
16 cm / 6 2/8"
75 mm

Fig. 4
17 cm / 6 6/8"
85 mm

Nasal Specula



1/2

08-105
Cottle

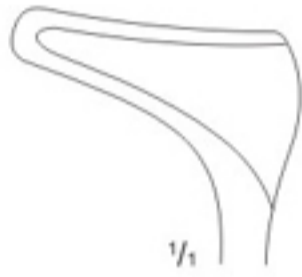

1/1

Fig. 1
13,5 cm / 5 3/8"
35 mm



Fig. 2
14 cm / 5 4/8"
50 mm



Fig. 3
16 cm / 6 2/8"
75 mm



Fig. 4
16 cm / 6 2/8"
85 mm



1/2

08-106
Goldsmith (Thudichum)
6,5 cm / 2 4/8"

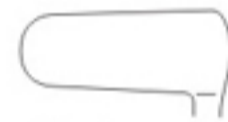

Fig. 1
21,0 x 9,5 mm



Fig. 2
21,0 x 10,5 mm

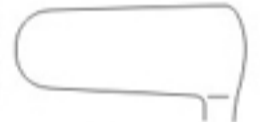

Fig. 3
21,0 x 11,5 mm



1/2

08-107
Mod. Wien 2
13,5 cm / 5 1/8"



1/1

Fig. 1
30 mm



08-108
Hartmann-Halle
16 cm / 6 1/8"



Fig. 1
27 mm



Fig. 2
31 mm

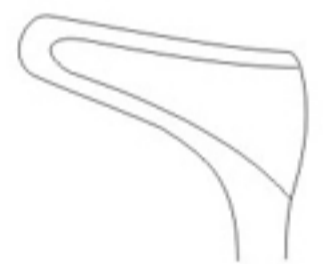

Fig. 3
35 mm

Anuscopes-Sphincteroscopes



08-109
IVES-FANSLER
Anuscope
145 mm
Ø24mm



08-110
KELLY
Sphincteroscope
160 mm
Ø21mm



08-111
KELLY
Sphincteroscope
160 mm
Ø27mm

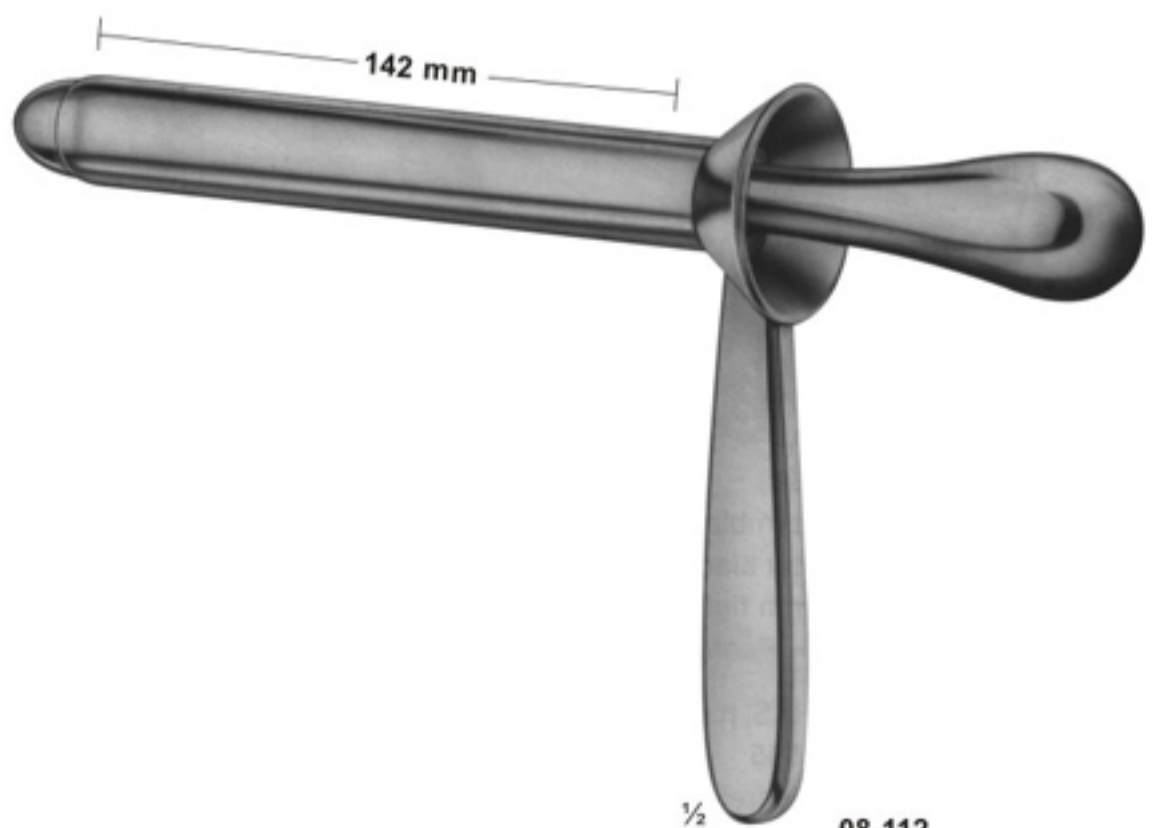

08-112
KELLY
Proctoscope
140 mm
Ø22mm

Haemorrhoidal Forceps

ATRAUMATA

Pressure Clamp

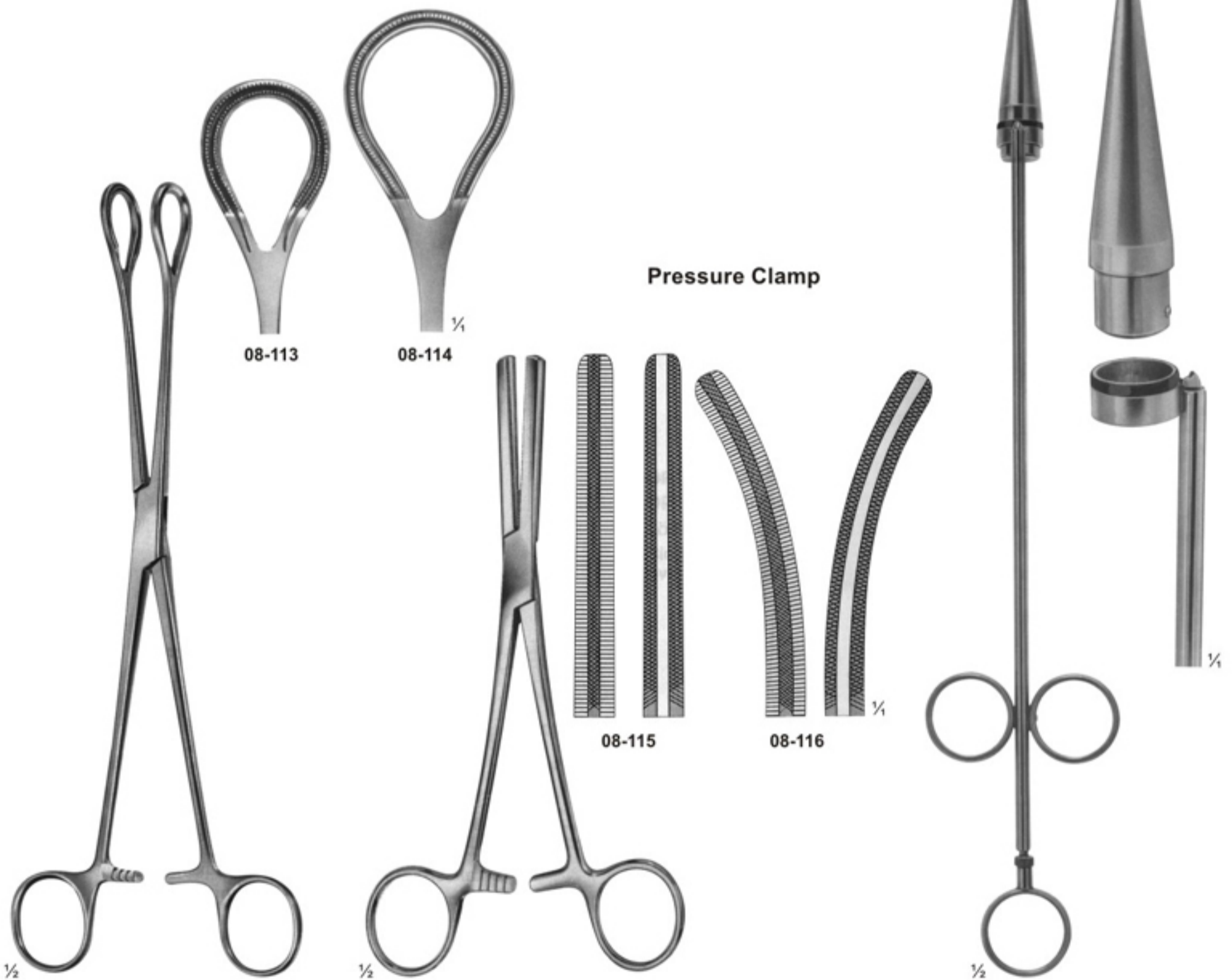

08-113 - 08-114
250 mm
08-114
270 mm

08-115 - 08-116
FERGUSSON
200 mm

08-117
RUDD
Haemorrhoidal ligator
with loading
attachment and 100
ligature rubber rings
315 mm

Gall Duct Forceps



08-118
LOWER
180 mm



08-119
LAHEY (SWEET)
190 mm



08-120
LAHEY
220 mm



08-121
DESJARDINS
Gall duct-and cystic forceps
210 mm



08-122
NISSEN
Gall duct-and cystic forceps
215 mm

Gall Duct Dilators and Gall Stone Scoops

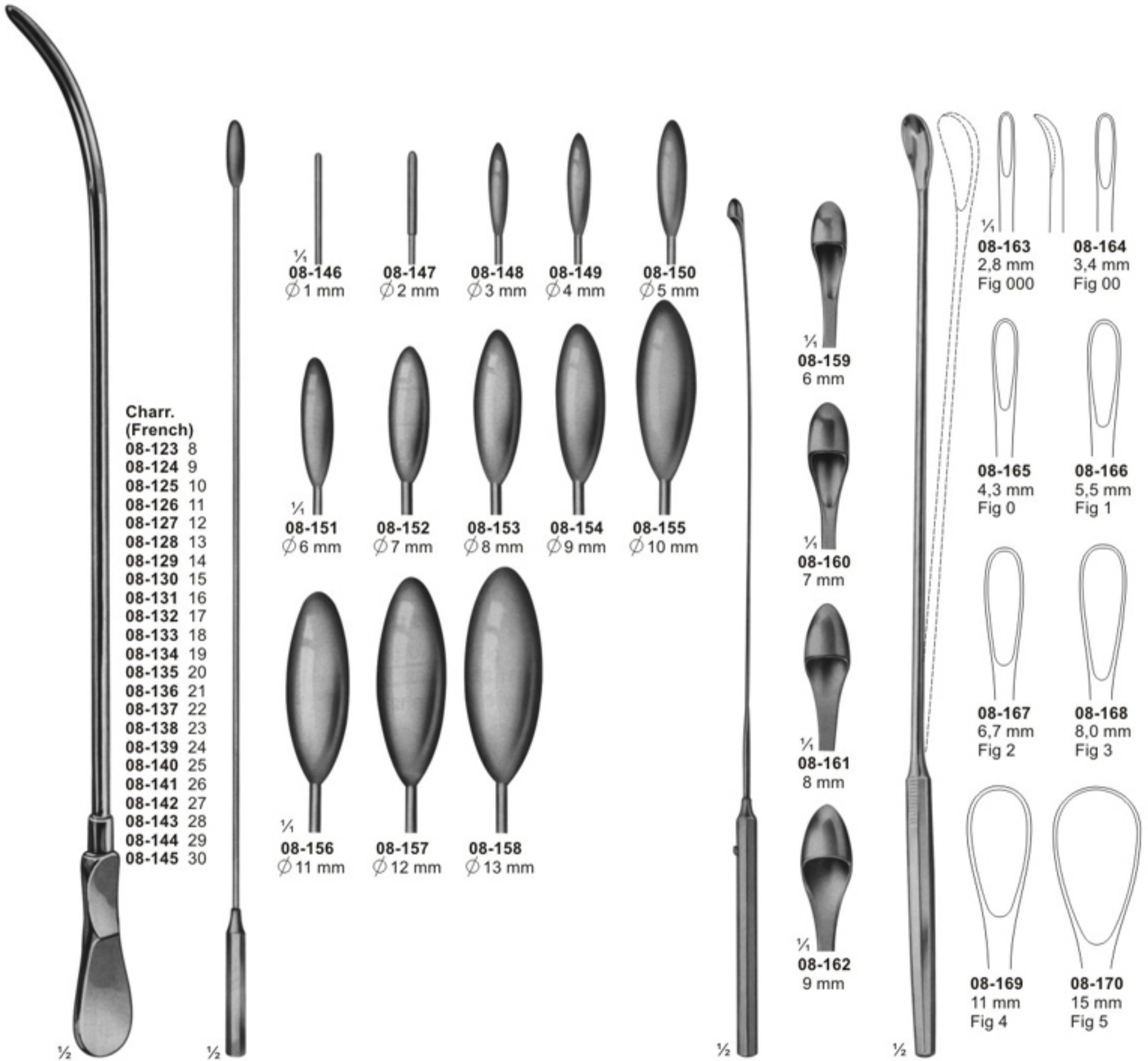

08-123 - 08-145
DITTEL
 Metall bougies and dilating sounds, stiff
 345 mm

08-146 - 08-158
BAKES
 Common bile duct dilators, malleable
08-146 - 08-150 315 mm
08-151 - 08-158 320 mm

08-159 - 08-162
DESJARDINS
 Probe and catch with flexible shaft
 300 mm

08-163 - 08-170
LUER-KOERTE modif
 with malleable shaft
 310 mm

Gall Stone Forceps

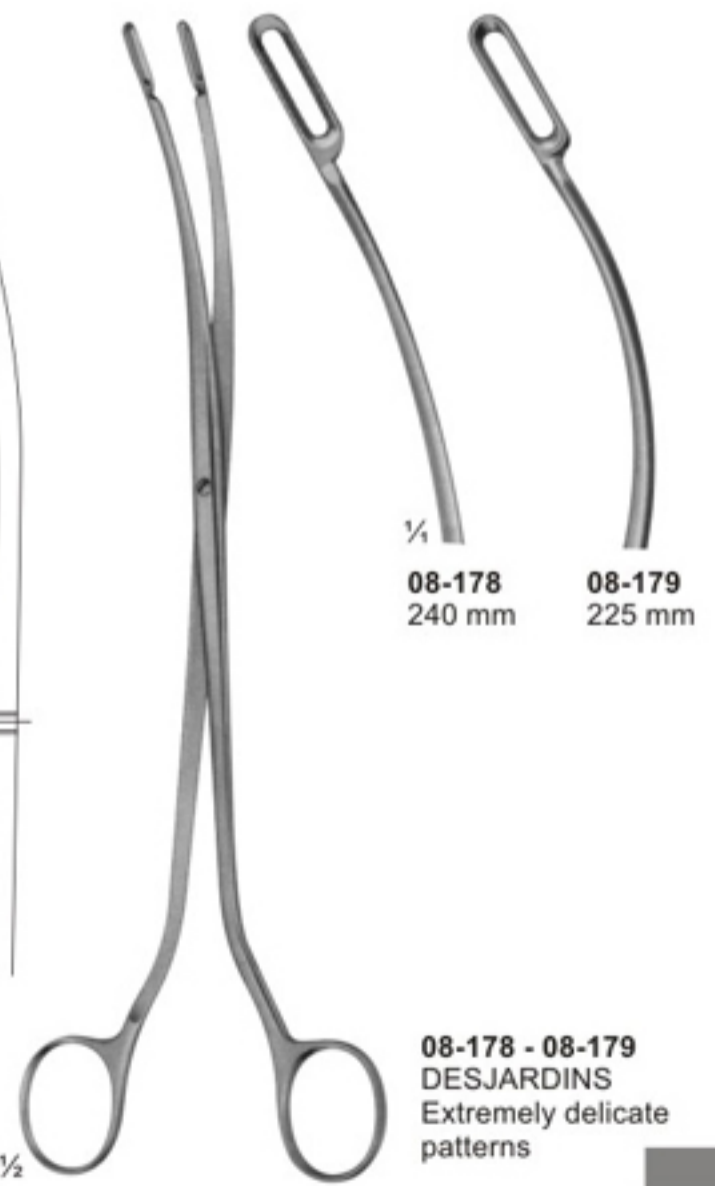
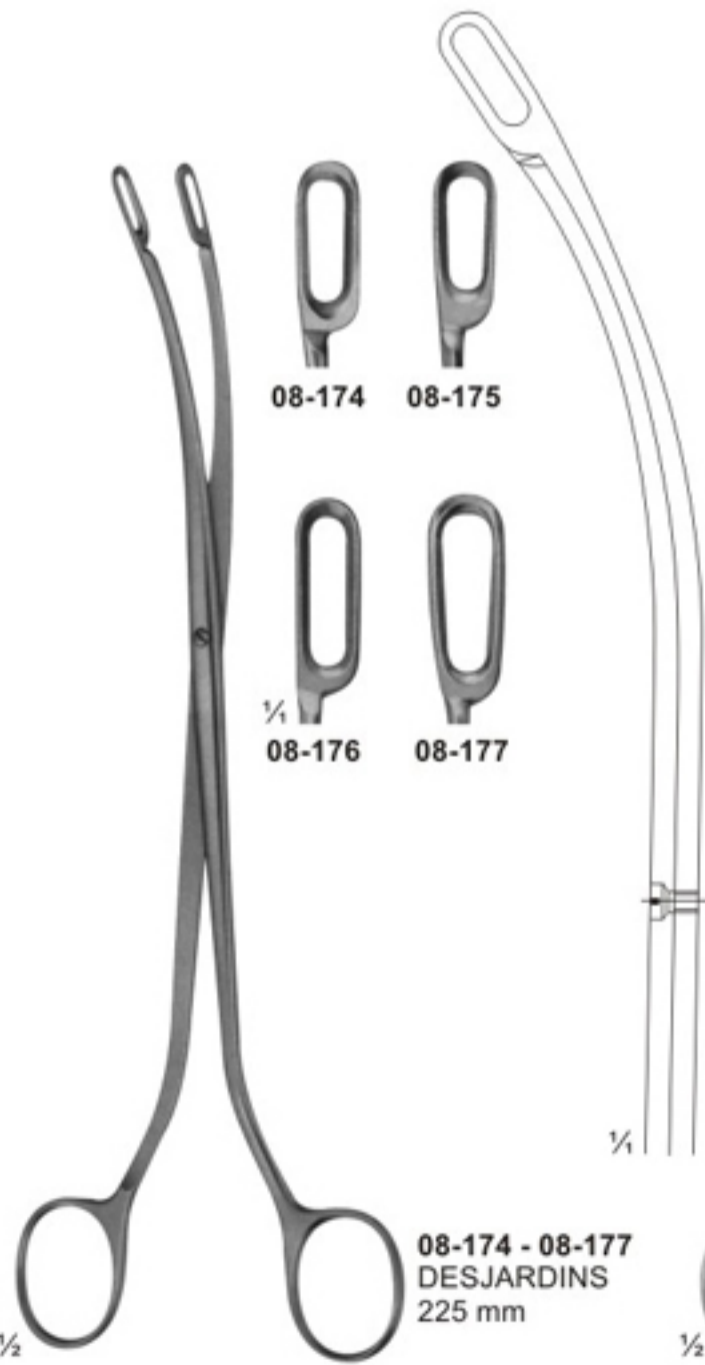
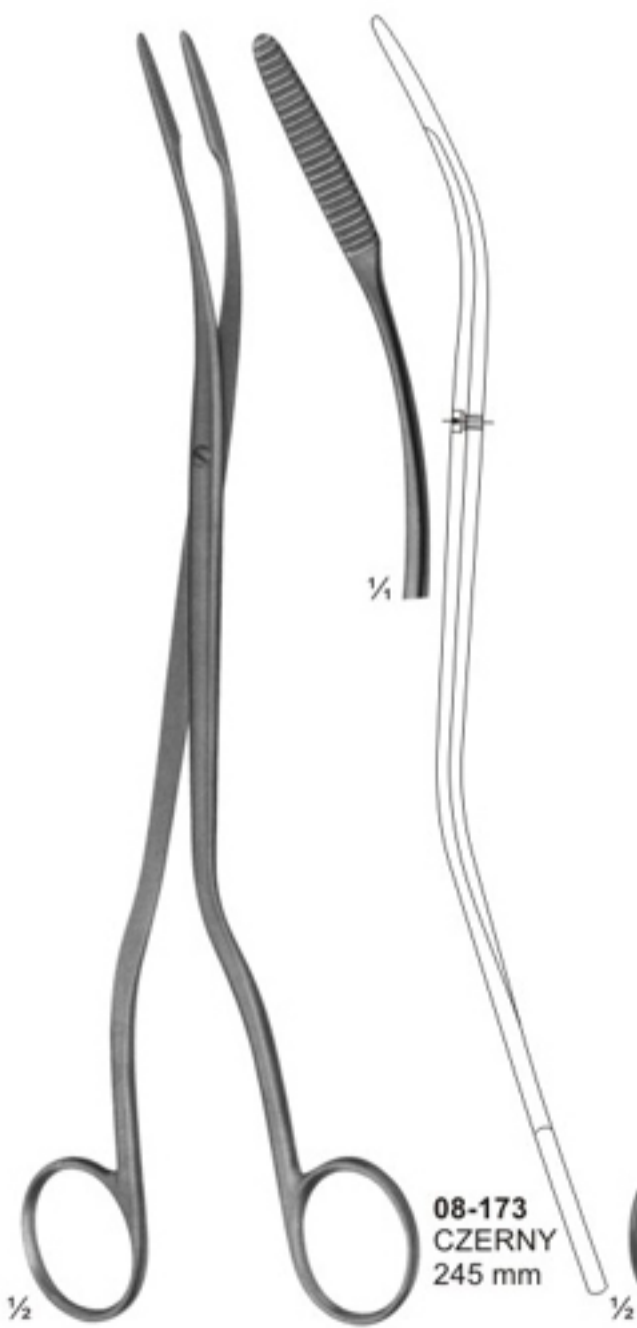
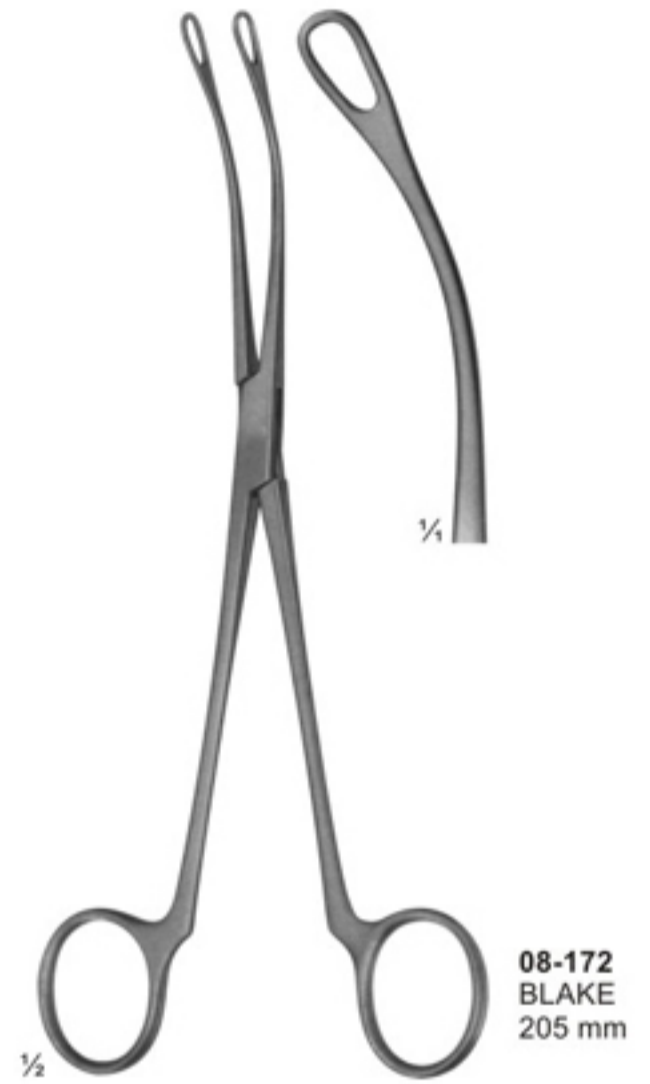

Kidney Clamps

ATRAUMATA

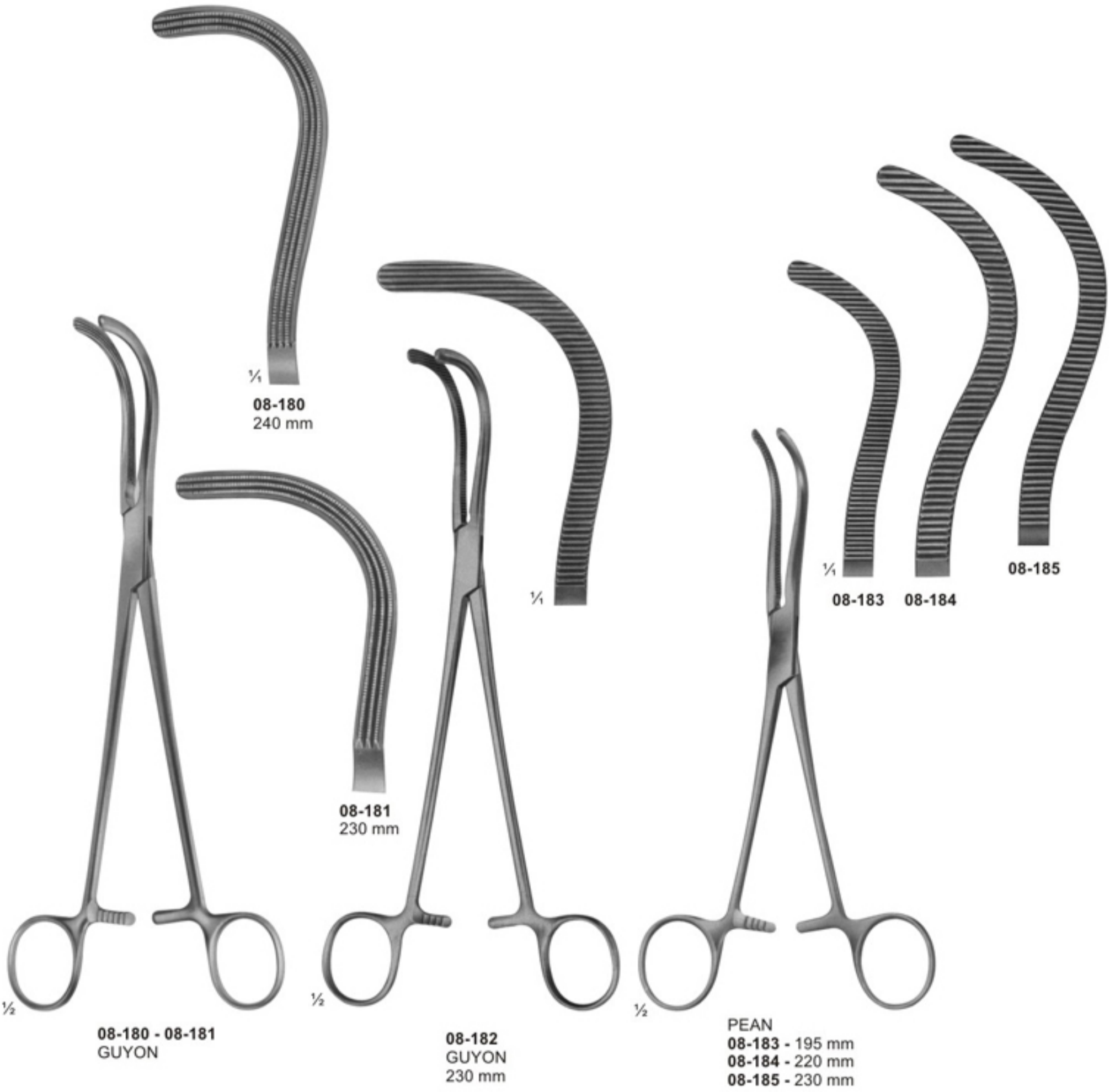

Kidney Stone Forceps



08-186



08-187



08-188



$\frac{1}{4}$
08-189



08-190



08-191



$\frac{1}{4}$
08-192



$\frac{1}{2}$

08-186 - 08-189
RANDALL
225 mm



$\frac{1}{2}$

08-190 - 08-192
RANDALL
190 mm

Bladder Retractors

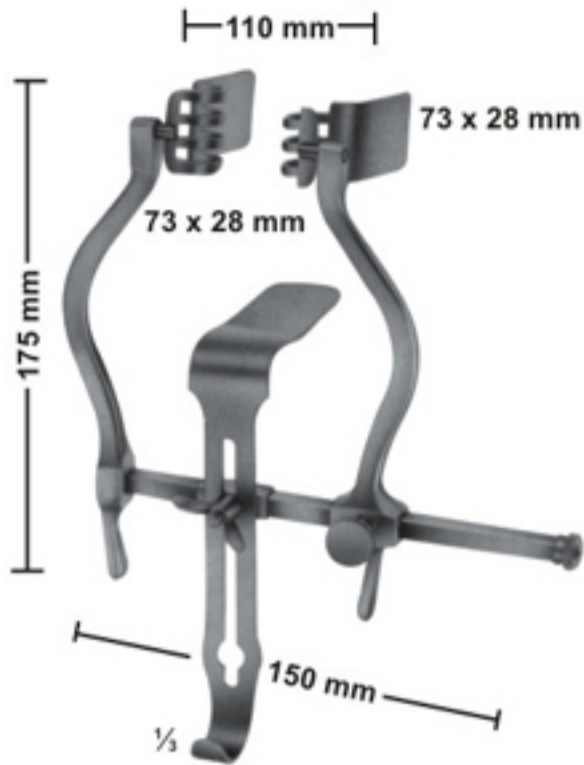

09-101
JUDD-MASSON
Bladder-and suprapubic
retractor

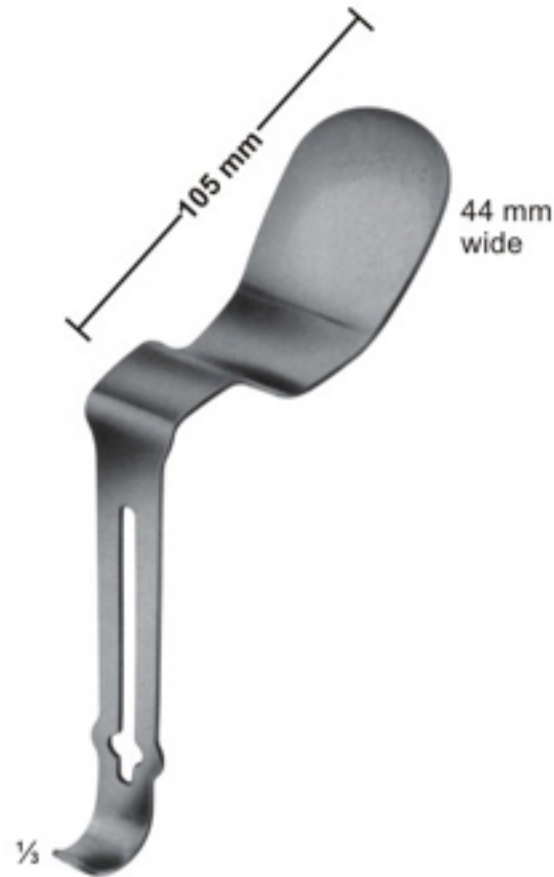

09-102
MILLIN
Center bladder for
retro pubic prostatectomy



09-103
MILLIN
Bladder retractor, complete
105X45 mm



09-104
LEGUEU
Bladder retractor
Center blade
80 x 31 mm



09-105
KOCHER
Bladder spatula
235 mm

Trocars



09-106
 KLIMA ROSEGGER
 35 X 1,8 mm
 Sternal puncture needle



09-107
 Universal trocar
 with 4 tips



NELSON

09-108 - 112
 Inside diam. Outside diam
09-108 2,2 mm 3,0 mm
09-109 3,0 mm 4,0 mm
09-110 4,0 mm 5,0 mm
09-111 5,0 mm 6,0 mm
09-112 5,5 mm 6,5 mm
 for hydrocele and abdominal puncture



09-113 - 116
 Inside diam. Outside diam
09-113 2,2 mm 3,0 mm
09-114 3,0 mm 4,0 mm
09-115 4,0 mm 5,0 mm
09-116 5,0 mm 6,0 mm
 for abdominal puncture,
 with stop-cock and lateral
 drain



09-117 - 118
 Inside diam. Outside diam
09-117 6,5 mm 8,0 mm
09-118 9,0 mm 10,0 mm
 Empyema trocar
 BUELEU

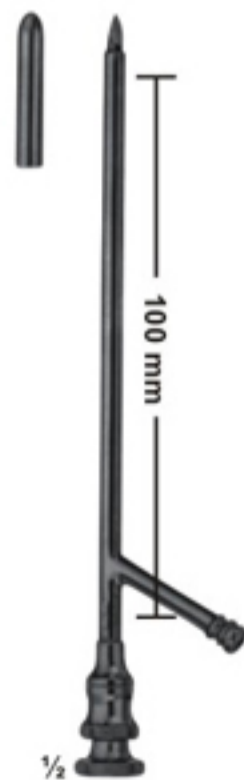

09-119 - 122
 Inside diam. Outside diam
09-119 3,0 mm 4,0 mm
09-120 3,6 mm 4,6 mm
09-121 4,3 mm 5,3 mm
09-122 5,0 mm 6,0 mm
 Gall bladder trocars. OCHSNER



09-123
 PIERCE
 Antrum trocar
 Ø 4,0 mm



09-124
 COAKLEY
 Antrum trocar
 3,0 mm

Vaginal Specula

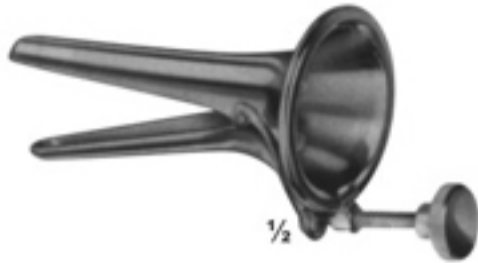

10-101
 COLLIN
 for children
 53 x 10 mm

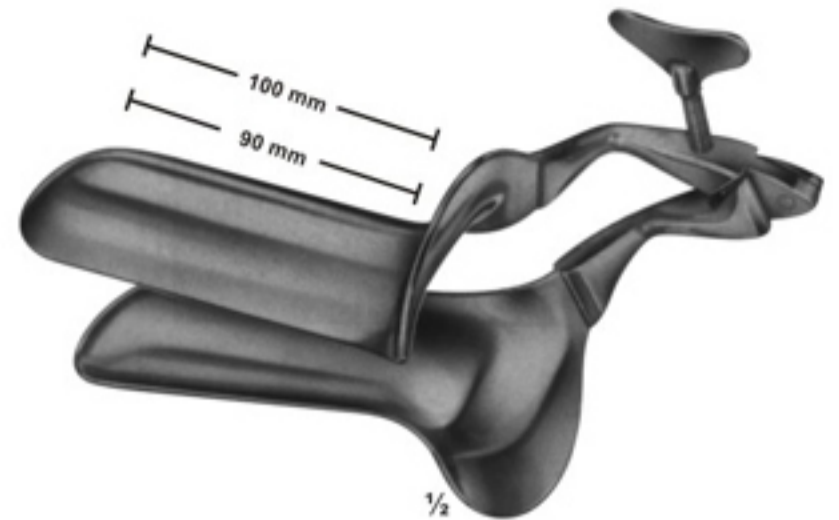

10-102 - 105
 COLLIN

10-102	100/90mm	28 mm
10-103	100/90mm	32 mm
10-104	105/95mm	35 mm
10-105	115/105mm	40 mm
Total length/working length		width



10-106
 COLLIN
 for virgins
 95/85 x 18 mm



10-107
 CUSCO
 for virgins
 75 x 17 mm



10-108
 CUSCO
 for virgins
 75 x 17 mm

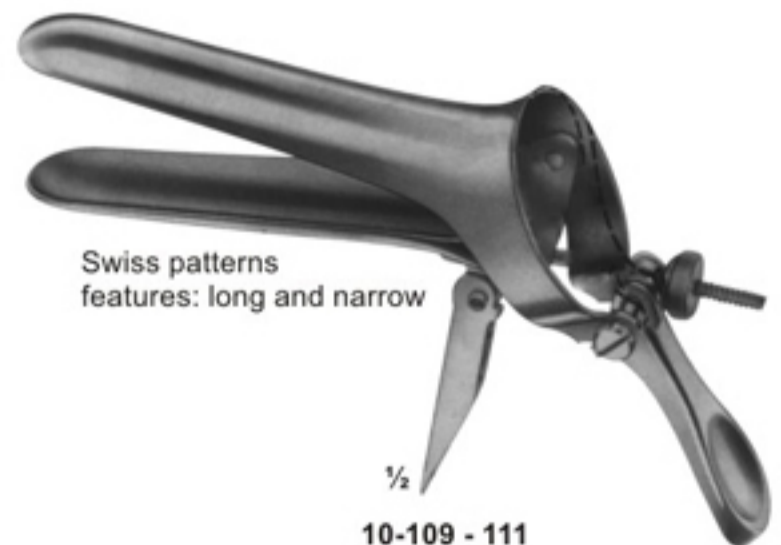

10-109 - 111
 CUSCO

10-109	92X23-25 mm
10-110	100x25-27 mm
10-111	110x27-30 mm

Vaginal Specula- Sets, upper and lower blades



10-112 - 114
GRAVE
 10-112 75X20 mm
 10-113 95X30 mm
 10-114 105X33 mm

½



10-115 - 116
PEDERSON
 10-115 100X22 mm
 10-116 120X25 mm

½



10-117 - 118
BRIESKY
 10-117 72X25 mm / 77X30 mm 140 mm
 10-118 75X30 mm / 92X38 mm 170 mm

½



½

10-119
SIMS
 70 X 26 mm / 75 X 30 mm
 75 X 30 mm / 80 X 35 mm
 80 X 36 mm / 90 X 40 mm
 175 mm



½

10-120 - 122
SEIDL
 10-120 80X8 mm
 10-121 80X10 mm
 10-122 90X14 mm
 For children and infants
 170 mm



½

10-123
KRISTELLER
 70X15 mm, (170 mm)
 For children



½

10-124 - 10-126
KRISTELLER
 10-124 70X27 mm
 10-125 75X30 mm
 10-126 90X36 mm
 175 mm

Vaginal Specula- upper and lower blades



10-127 - 131
KRISTELLER
10-127 110X18 mm
10-128 110X20 mm
10-129 110X27 mm
10-130 110X30 mm
10-131 110X36 mm
220 mm

10-132 - 10-135
KRISTELLER
Upper blades

10-136 - 10-139
KRISTELLER
Lower blades

Vaginal Specula

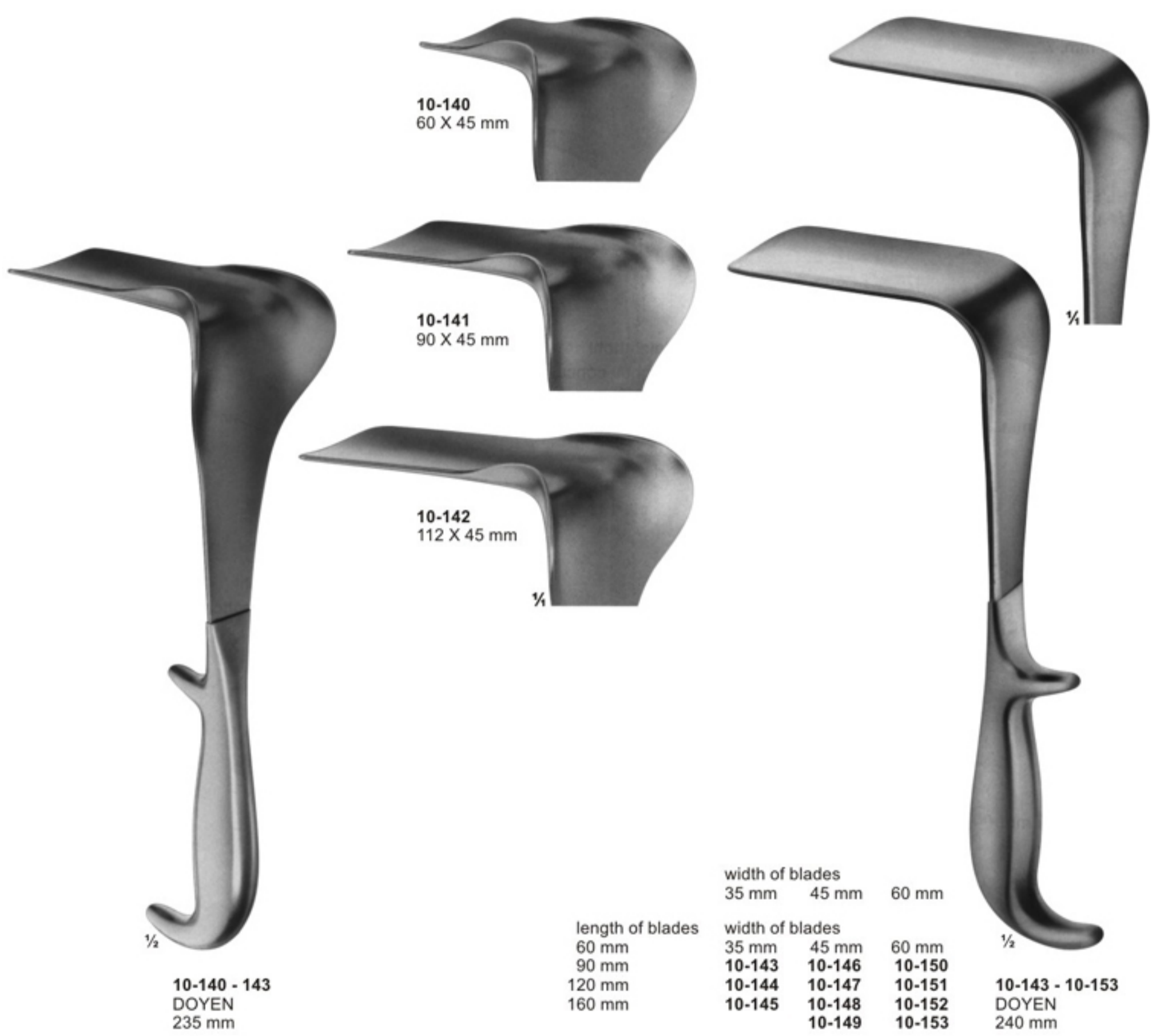

Vaginal Retractors



10-154
JOLL (FRIEDMAN)
155 mm



10-155
RICHTER
170 mm



10-156
GELPI
135 mm



10-157
GELPI
175 mm

Uterine Dilators



11-101 - 143
 HEGAR
 with very conical point
 185 mm

11-101	1	mm	11-123	23	mm
11-102	2	mm	11-124	24	mm
11-103	3	mm	11-125	25	mm
11-104	4	mm	11-126	26	mm
11-105	5	mm	11-127	1	½mm
11-106	6	mm	11-128	2	½mm
11-107	7	mm	11-129	3	½mm
11-108	8	mm	11-130	4	½mm
11-109	9	mm	11-131	5	½mm
11-110	10	mm	11-132	6	½mm
11-111	11	mm	11-133	7	½mm
11-112	12	mm	11-134	8	½mm
11-113	13	mm	11-135	9	½mm
11-114	14	mm	11-136	10	½mm
11-115	15	mm	11-137	11	½mm
11-116	16	mm	11-138	12	½mm
11-117	17	mm	11-139	13	½mm
11-118	18	mm	11-140	14	½mm
11-119	19	mm	11-141	15	½mm
11-120	20	mm	11-142	16	½mm
11-121	21	mm	11-143	17	½mm
11-122	22	mm			



11-144 - 152
 HEGAR
 205 mm

11-144	1+2	mm
11-145	3+4	mm
11-146	5+6	mm
11-147	7+8	mm
11-148	9+10	mm
11-149	11+12	mm
11-150	13+14	mm
11-151	15+16	mm
11-152	17+18	mm

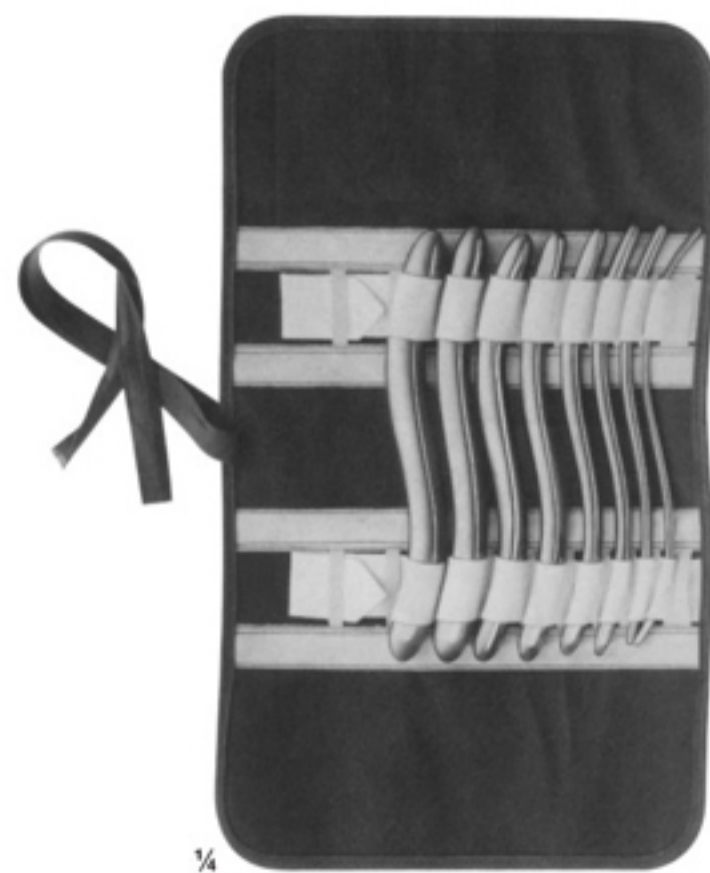

11-153
 HEGAR
 Uterine dilator set, in canvas
 roll with 8 dilators.

Uterine Probes

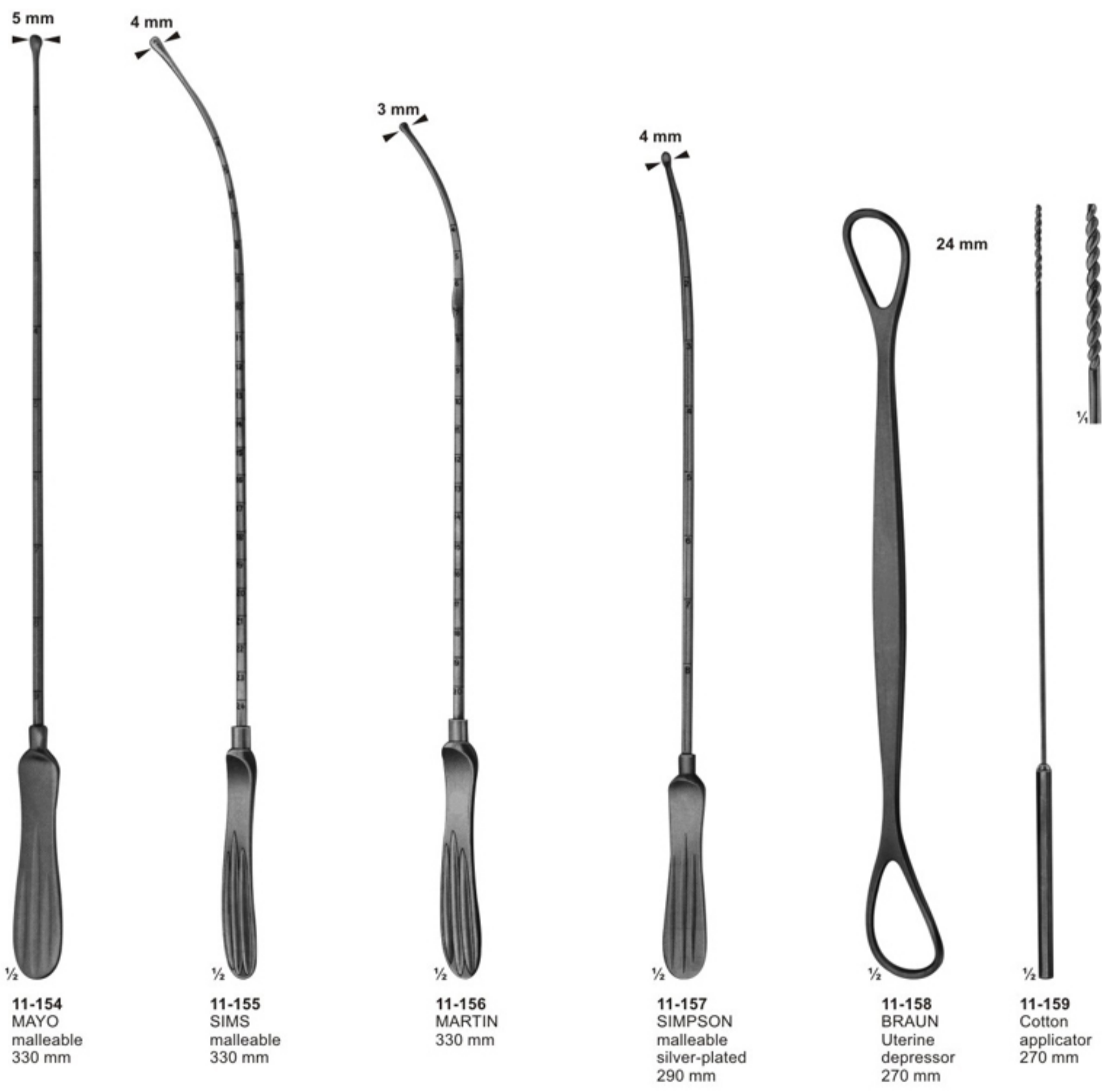

11-154
MAYO
malleable
330 mm

11-155
SIMS
malleable
330 mm

11-156
MARTIN
330 mm

11-157
SIMPSON
malleable
silver-plated
290 mm

11-158
BRAUN
Uterine
depressor
270 mm

11-159
Cotton
applicator
270 mm

Uterine Dressing Forceps



11-160
PELMANN
260 mm



11-161
PELMANN
260 mm

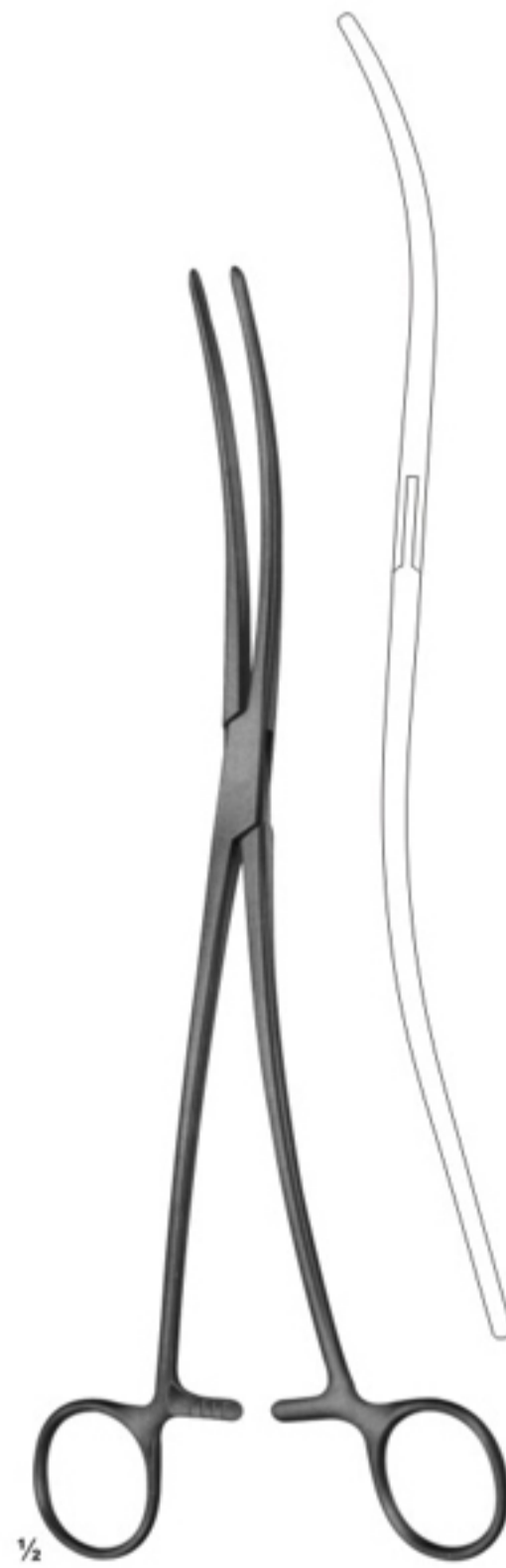

11-162
BOZEMANN
250 mm



11-163
BOZEMANN
255 mm

Jaws with longitudinal groove

Polypus-and Ovum Forceps

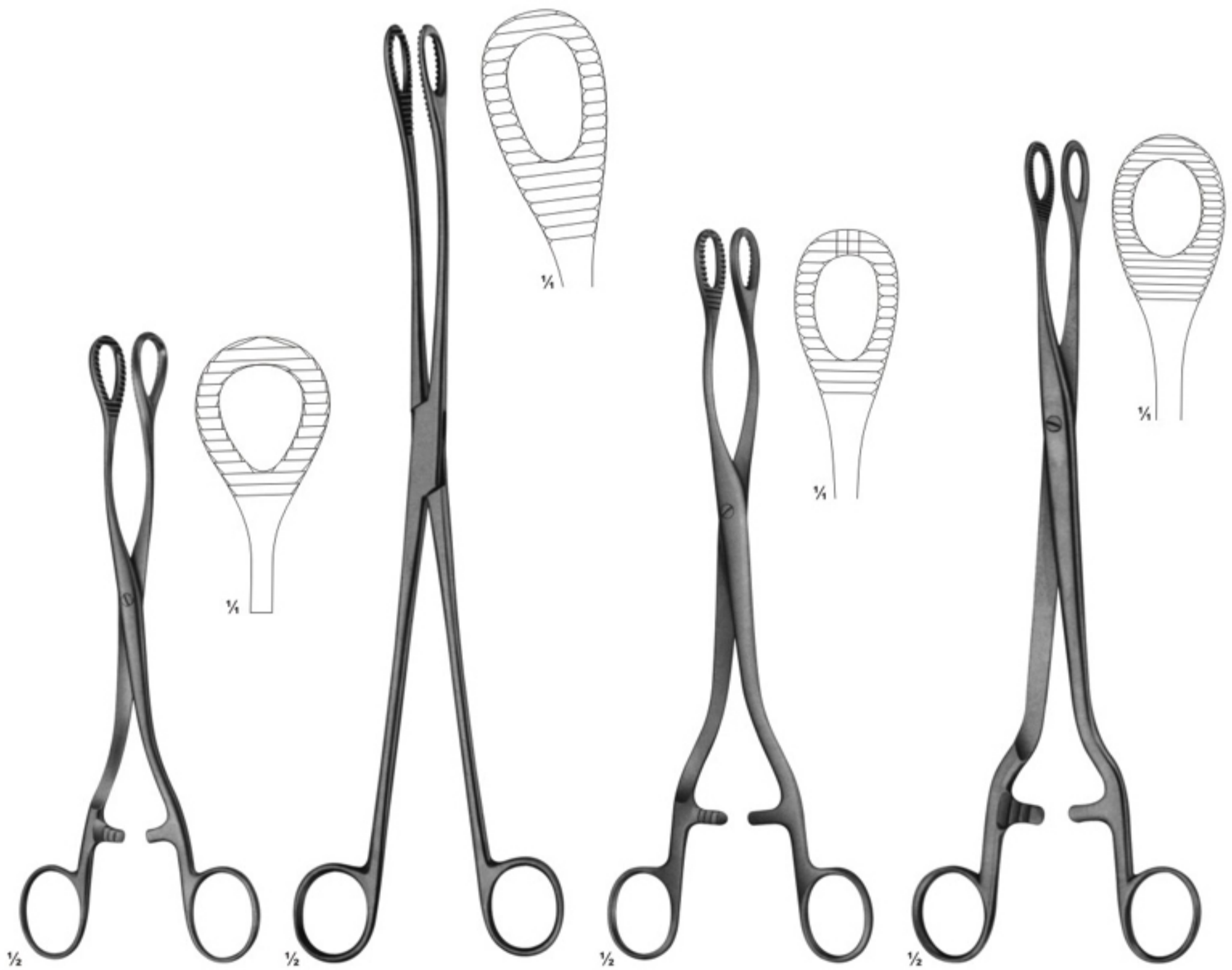

11-164
HEYWOOD-SMITH
200 mm

11-165
KELLY
320 mm

11-166
HEYWOOD-SMITH
250 mm

11-167
NOTO
280 mm

Ear Curettes



12-101
 Langenbeck
 13 cm / 5 1/8"

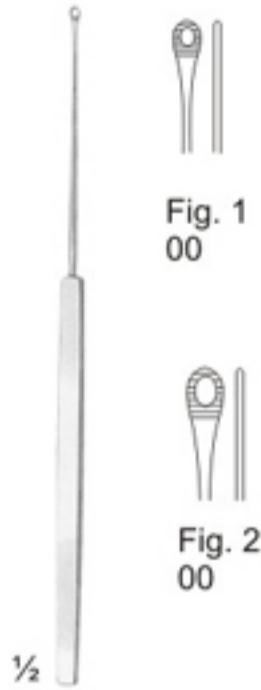

12-102
 Shapleigh
 15 cm / 5 1/8"

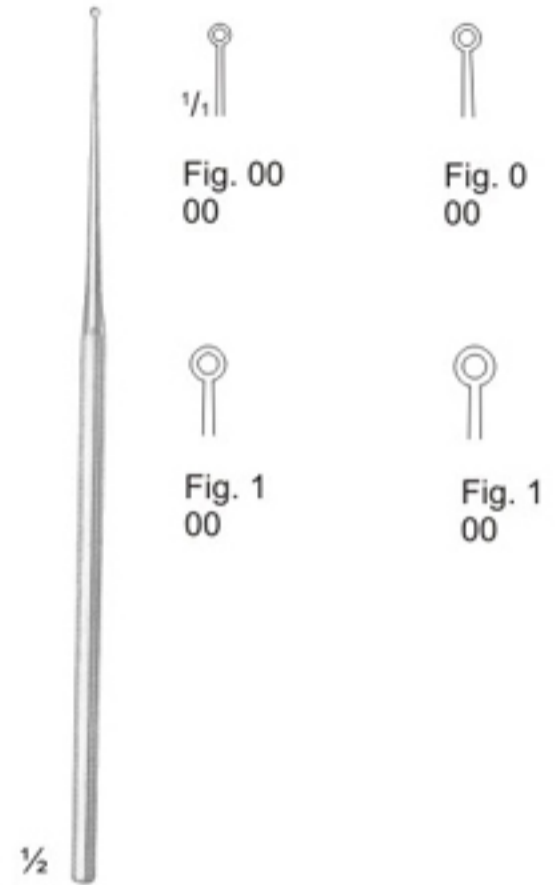

12-103
 Buck
 17cm / 6 6/8"



12-104
 Buck
 15 cm / 6 6/8"

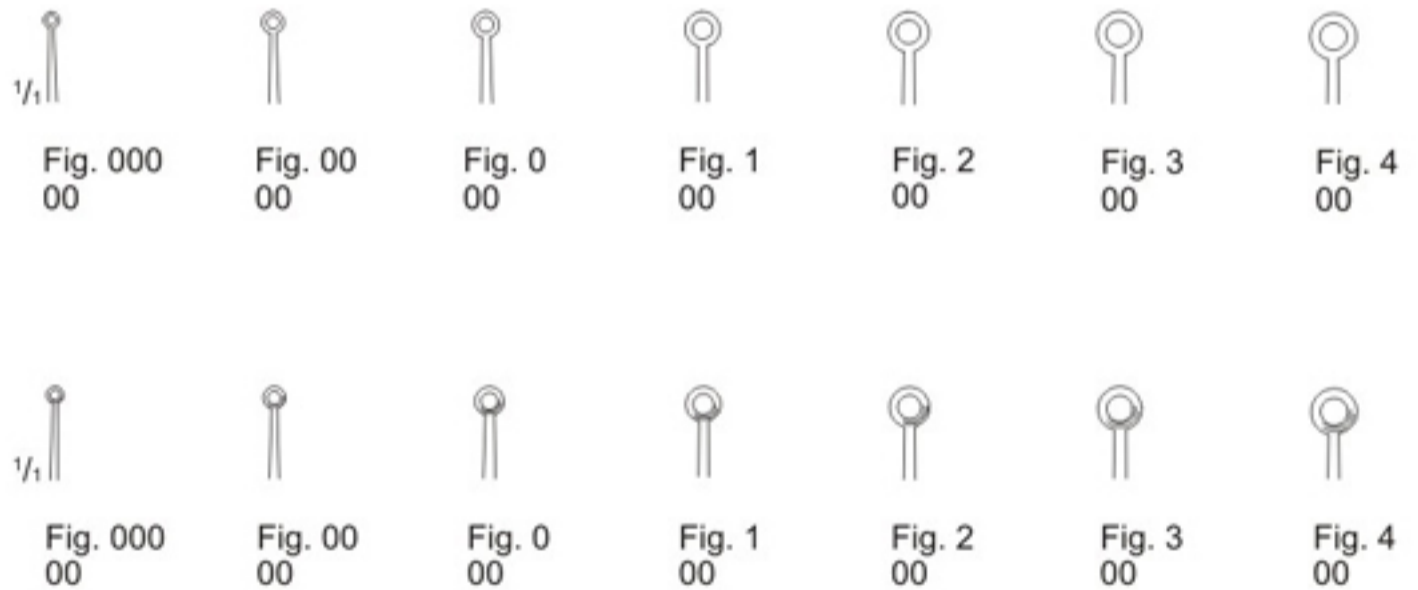

Biopsy Curettes

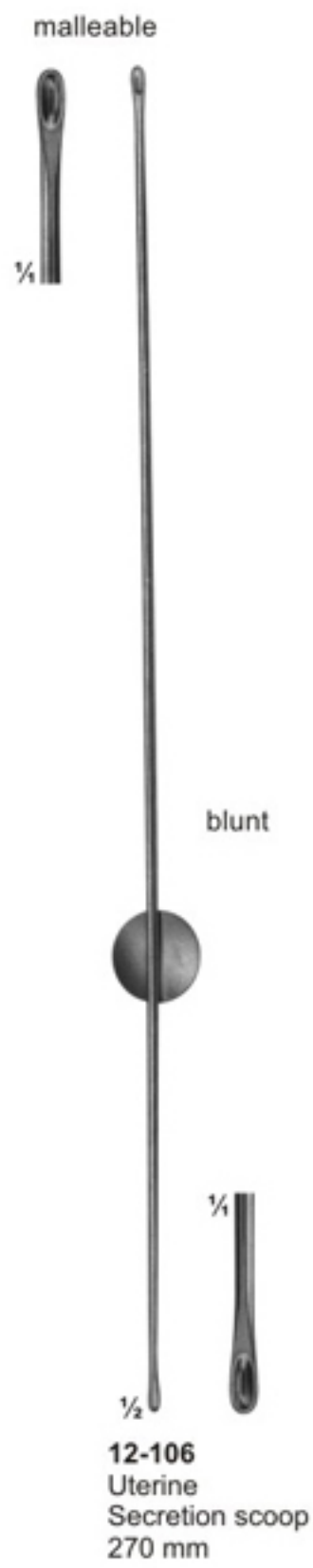
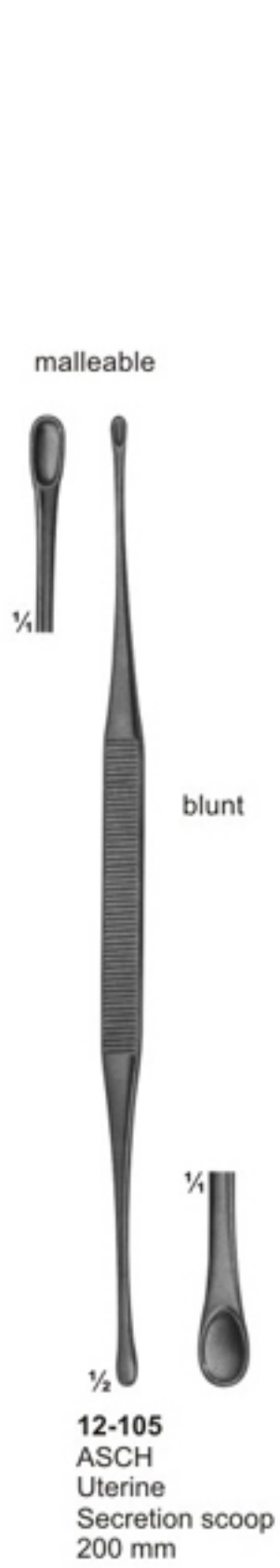

Ear Polypus Forceps



12-109
 Hartmann-Wullstein
 shaft length
 85 mm



12-110
 Hartmann-Wullstein
 shaft length
 85 mm



12-111
 Hartmann
 shaft length
 85 mm



12-112
 Hartmann
 shaft length
 85 mm



$\frac{1}{2}$
12-109 - 12-119

12-113
 14 cm / 5 4/8"
 shaft length
 140 mm



$\frac{1}{3}$
12-114
 Hartmann-Herzfelr
 2,0 mm
 shaft length
 85mm



12-115
 Hartmann
 3 mm
 shaft length
 85mm

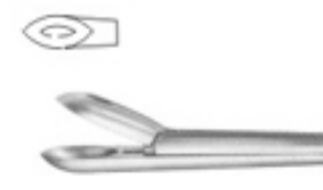

12-116
 shaft length
 85mm

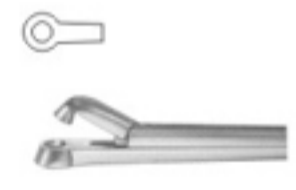

12-117
 Hartmann-Hoffmar
 2,0 mm
 85mm

12-118
 2,5 mm
 85 mm

12-119
 3,0 mm
 85 mm

Biopsy forceps for rectum

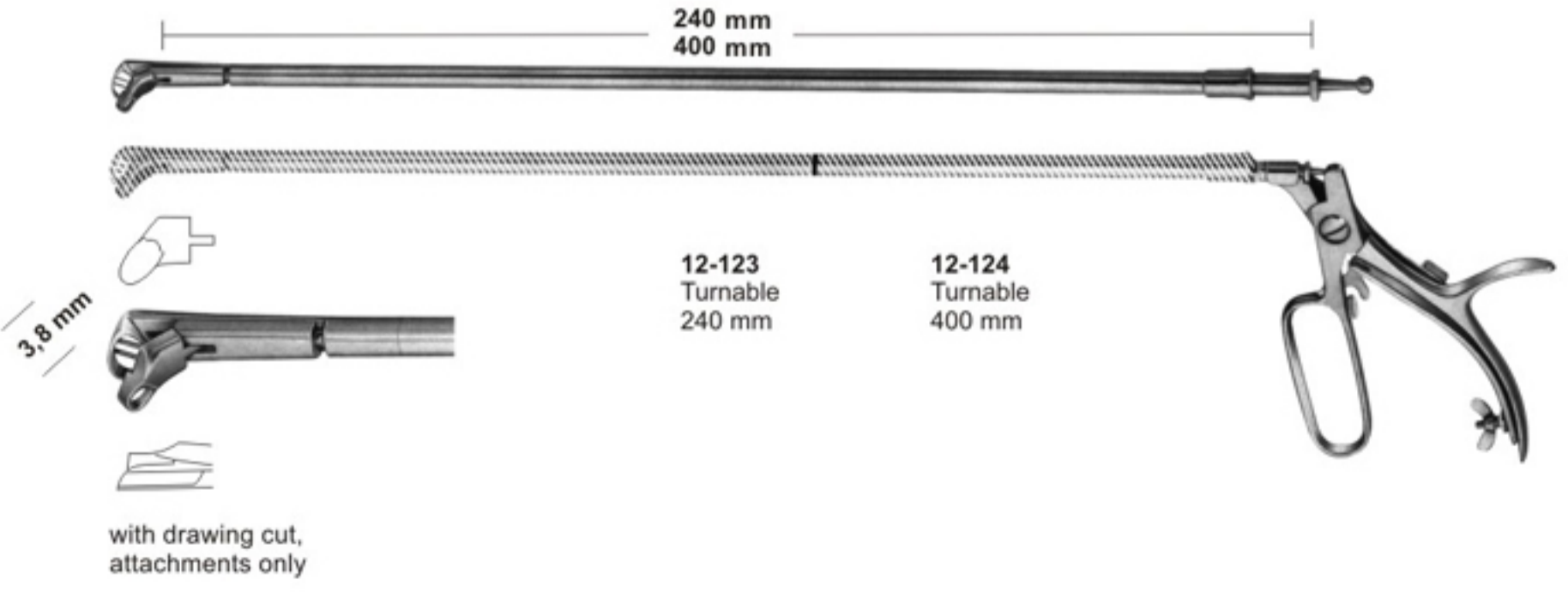
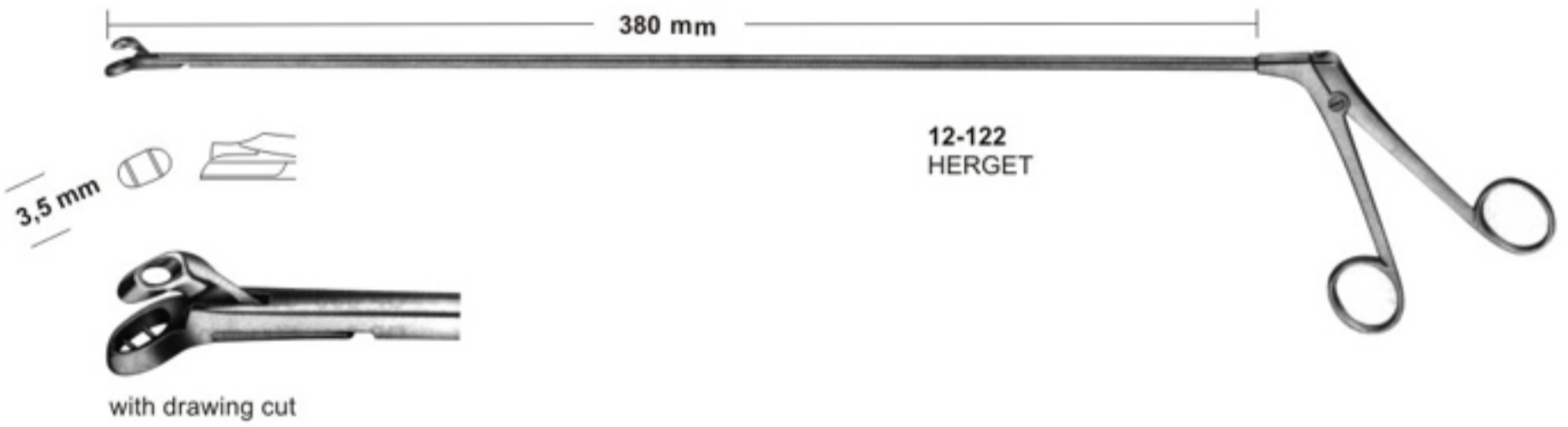
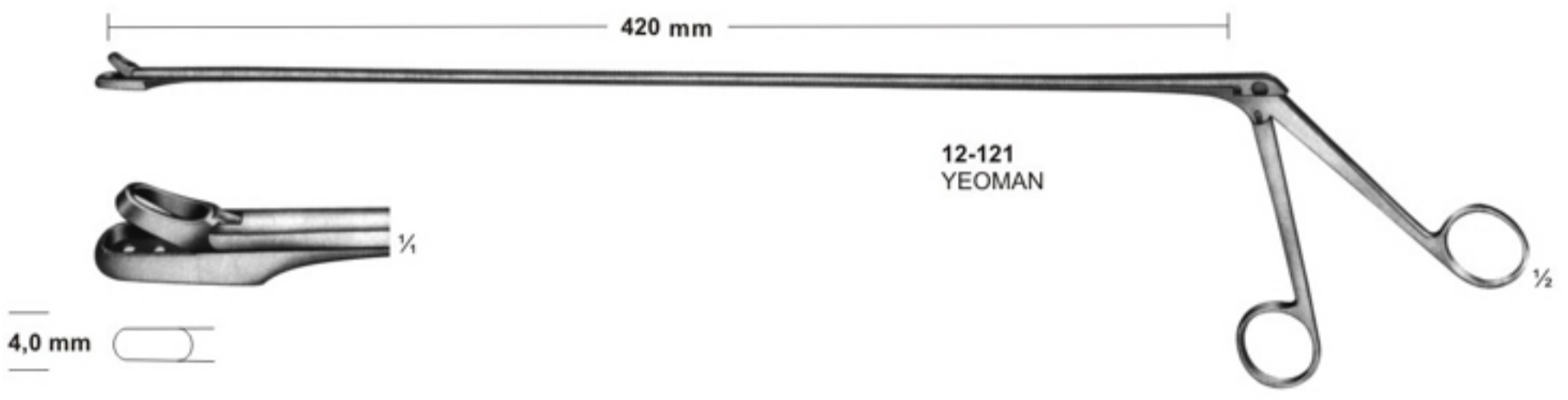
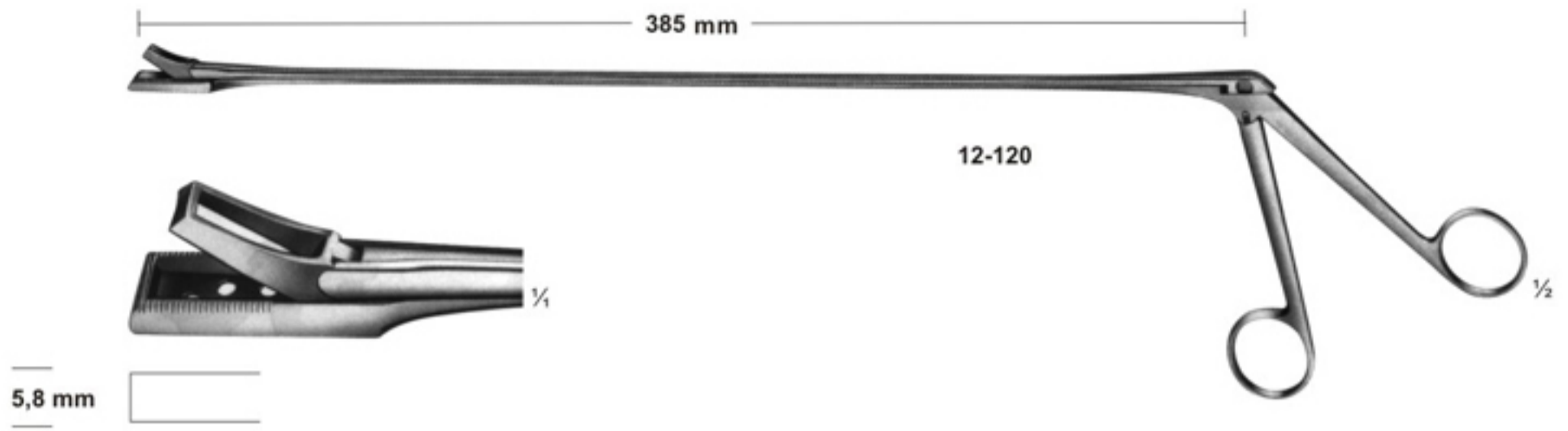

Biopsy Forceps

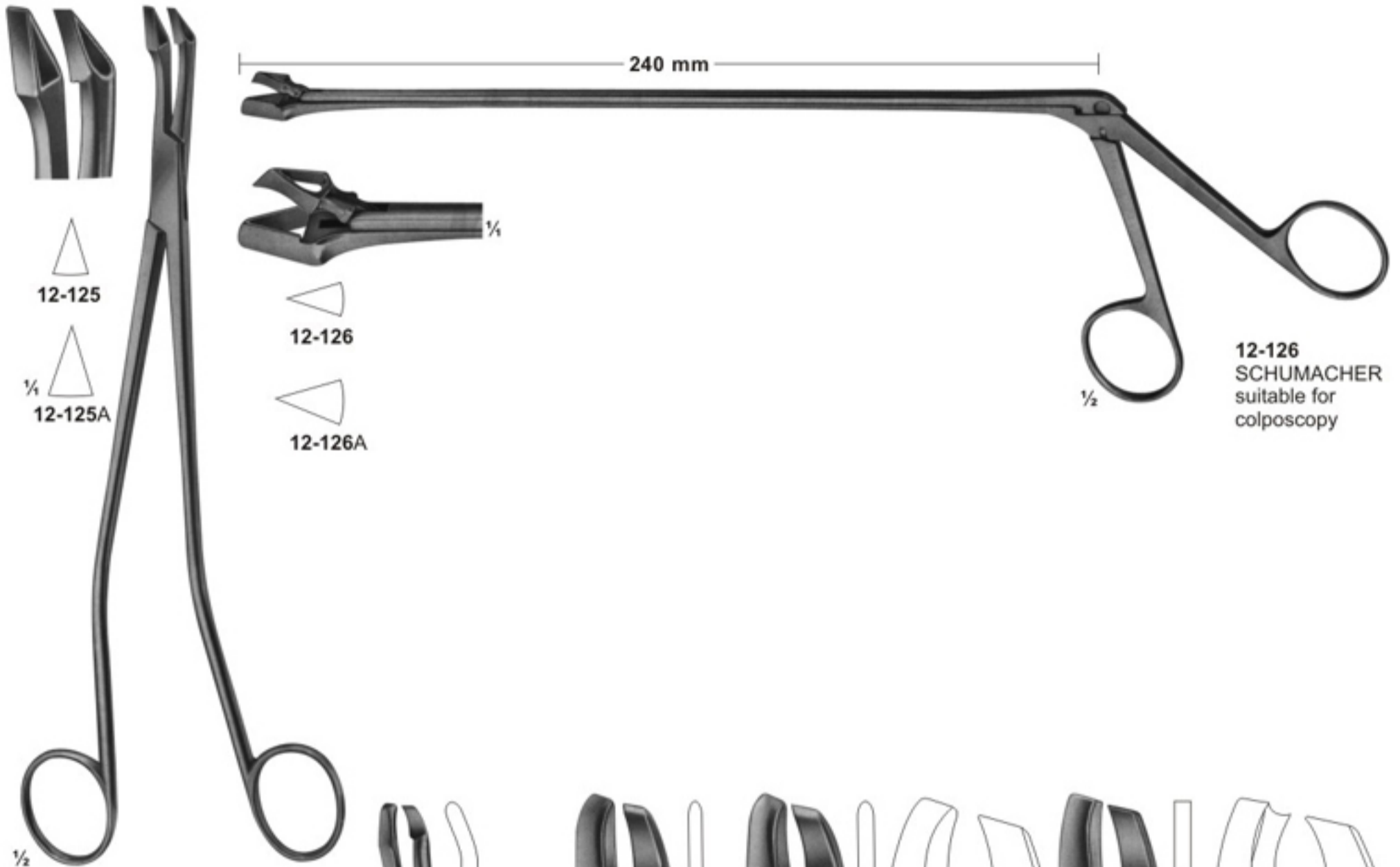

12-125
SCHUMACHER
240mm

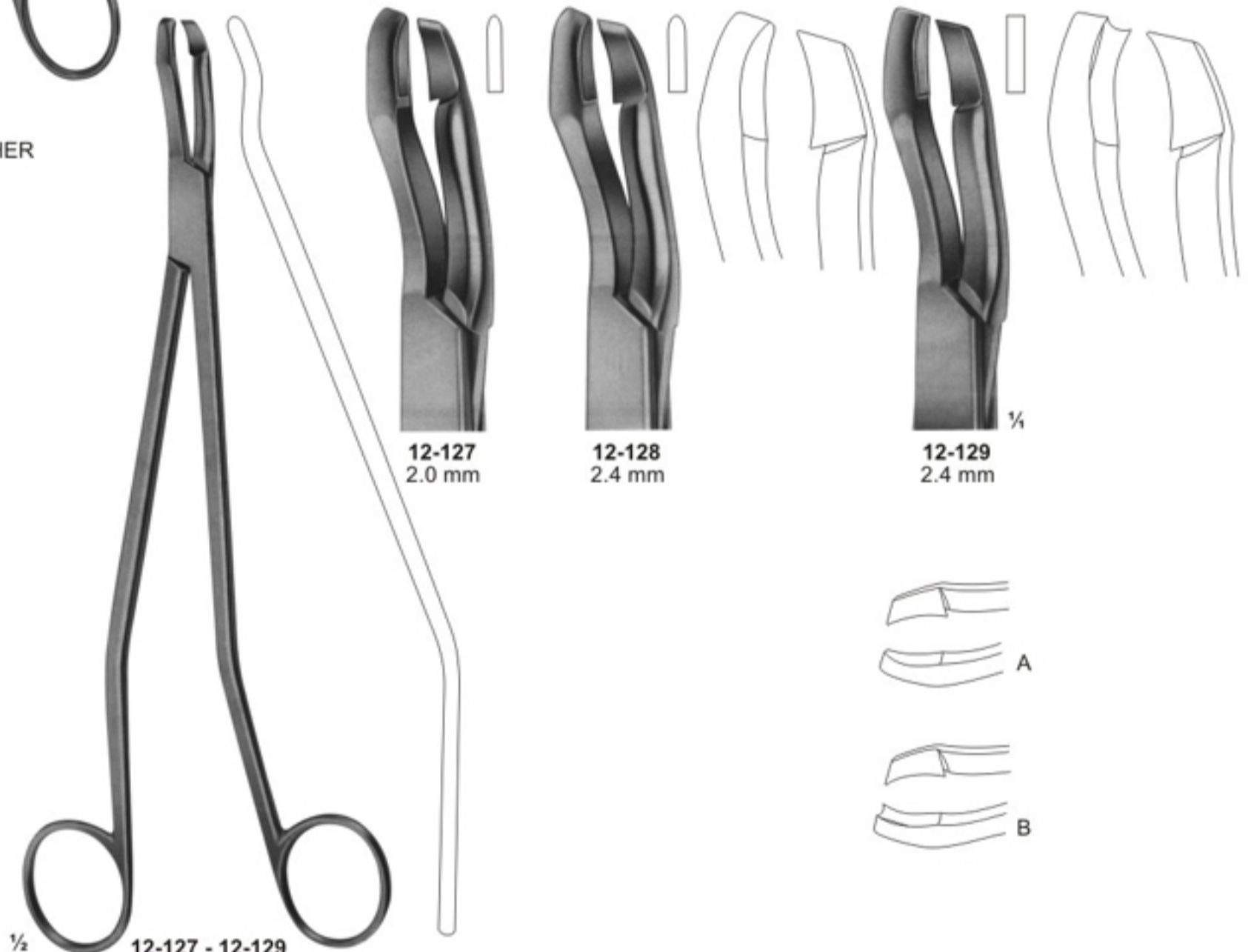

12-127 - 12-129
SEIDL DBP
Biopsy forceps, bayonet shaped
for portio, vagina and vulva
240mm

Biopsy Forceps

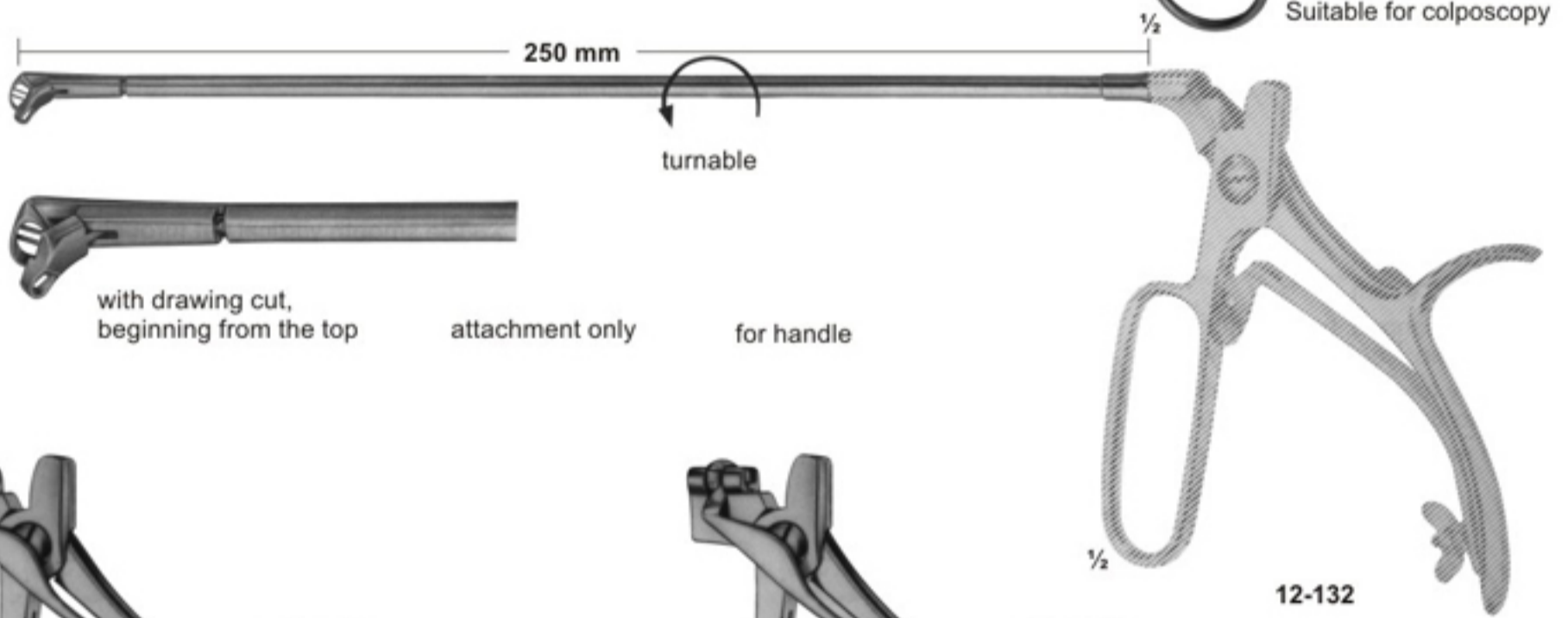
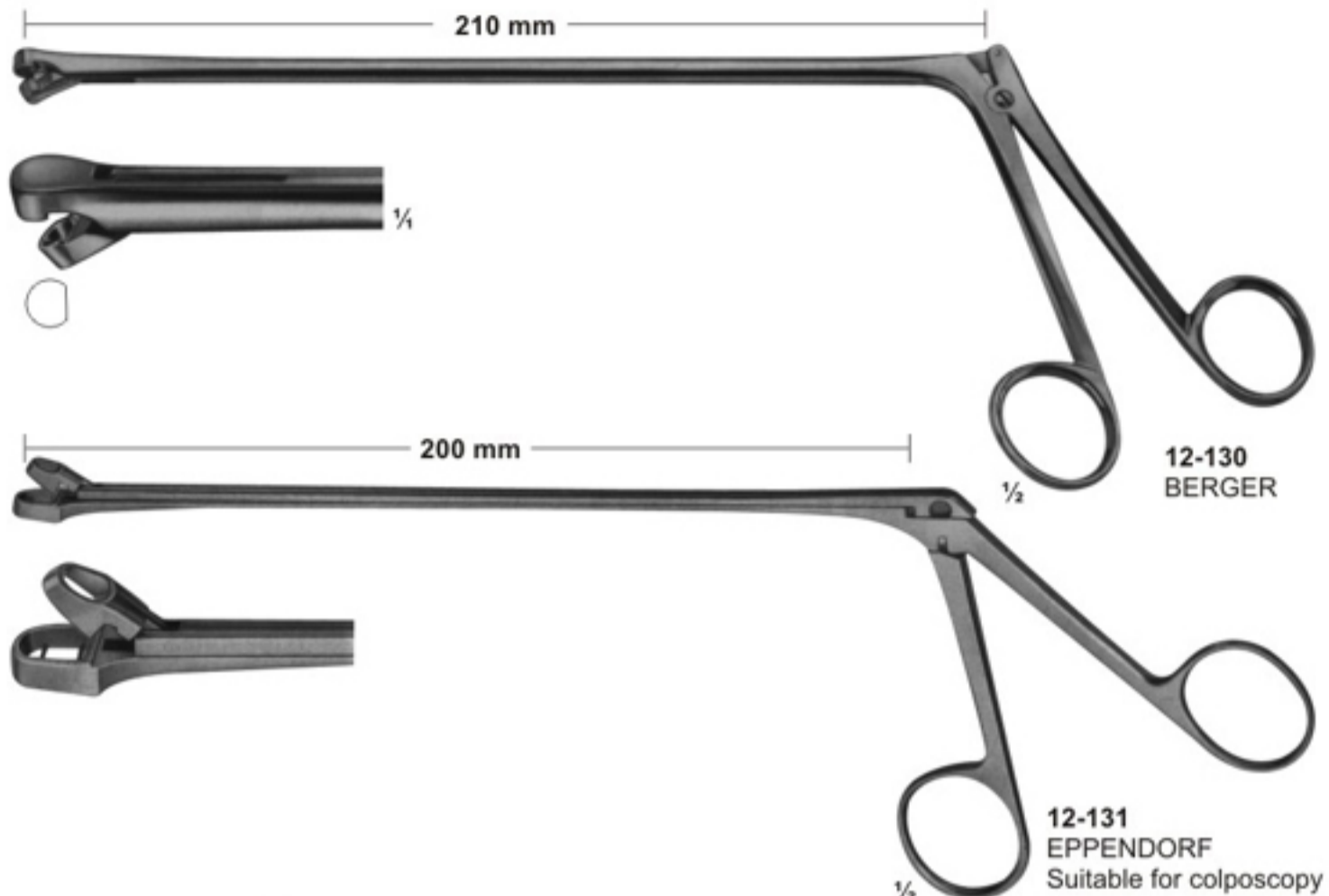

Uterine Scoops

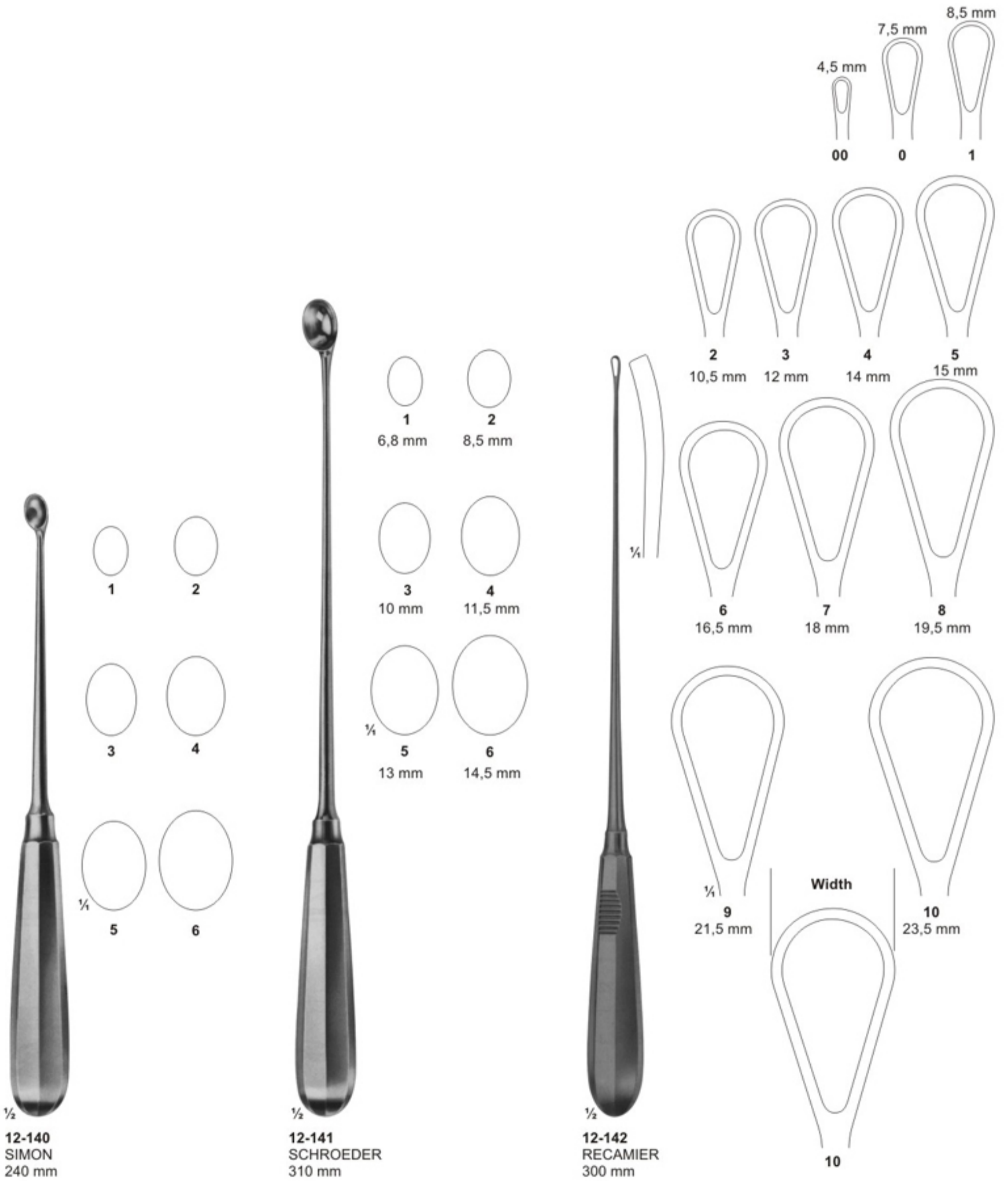

Obstetrical Forceps



1/3

13-101
NAEGELE
355 mm



1/3

13-102
NAEGELE
400 mm



1/3

13-103
SIMPSON-BRAUN
305mm

Obstetrics- Placenta and Ovum Forceps

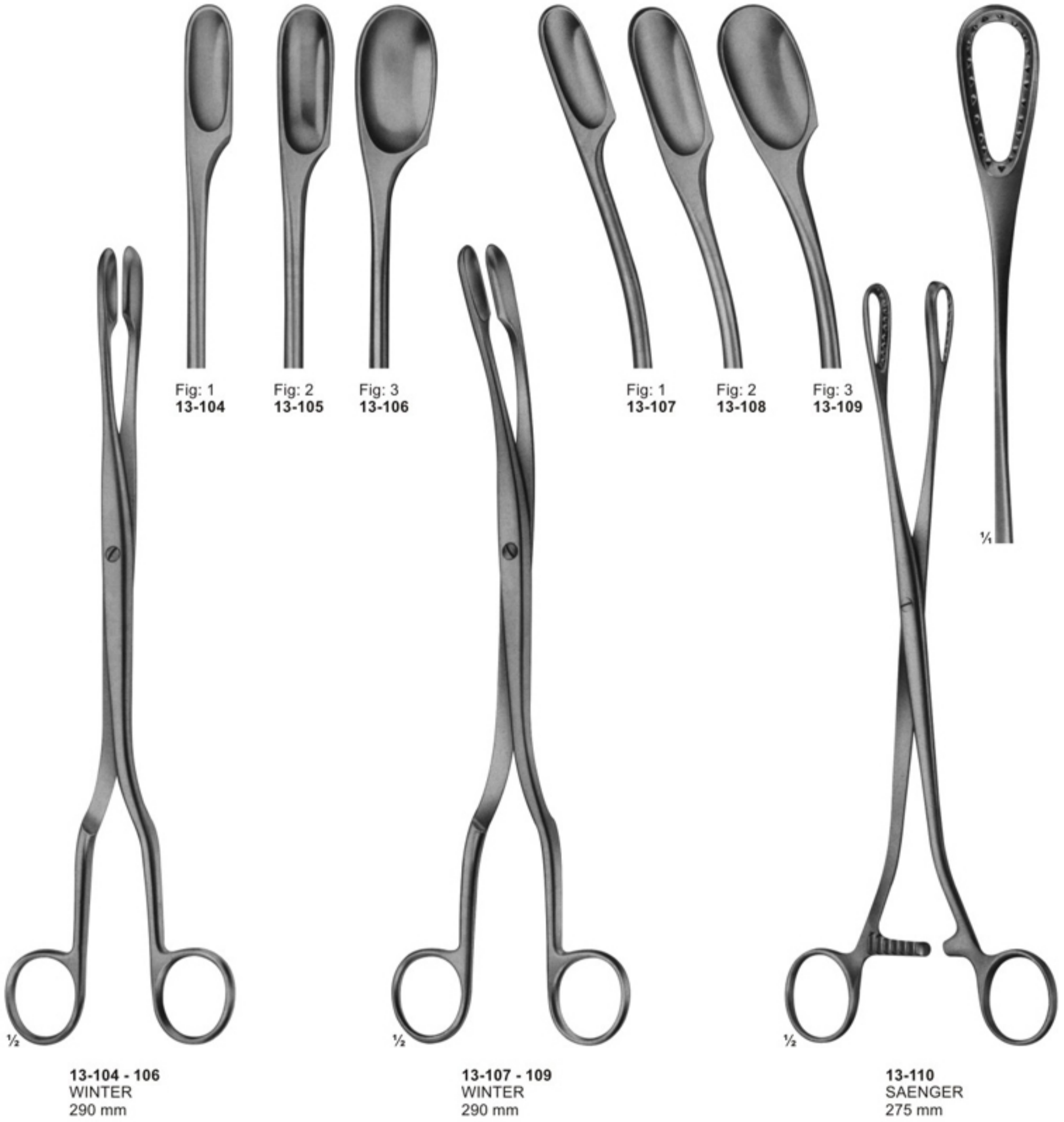

Toung-and Tracheal Hooks and Dilators



**13-111
BOSE**
165 mm



**13-112
BOSE**
165 mm



13-113 - 115
180 mm

13-113
sharp



13-114
blunt



13-115
stumpf/blunt



**13-116
FINSEN**
50 mm



**13-117
FINSEN**
70 mm



**13-118
TROUSSEAU**
120 mm



**13-119
LABORDE**
125 mm



**13-120
LABORDE**
strong pattern
135 mm



13-121
Cleaning Brush
for tracheal tubes
285 mm

Vascular Spatulas

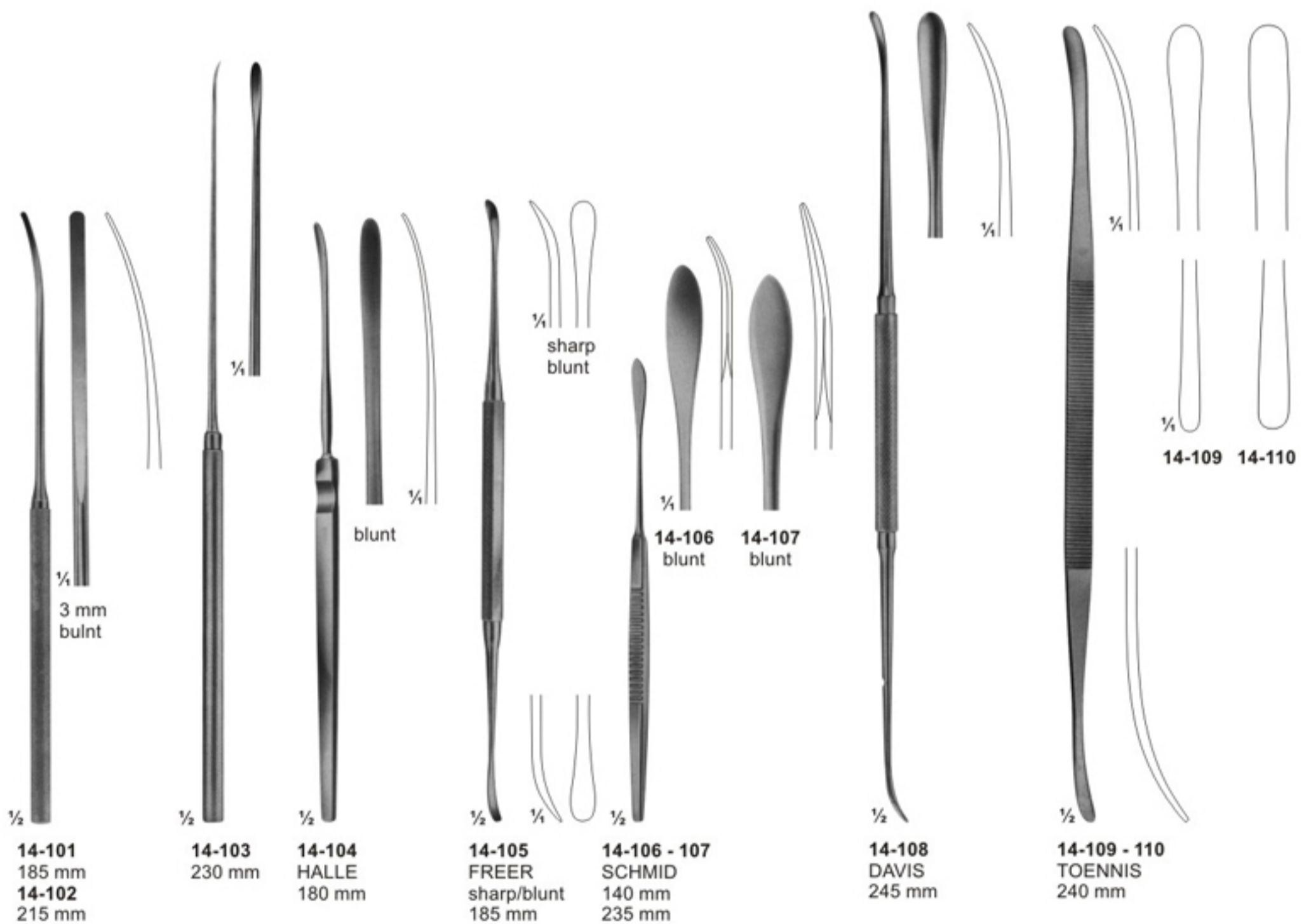

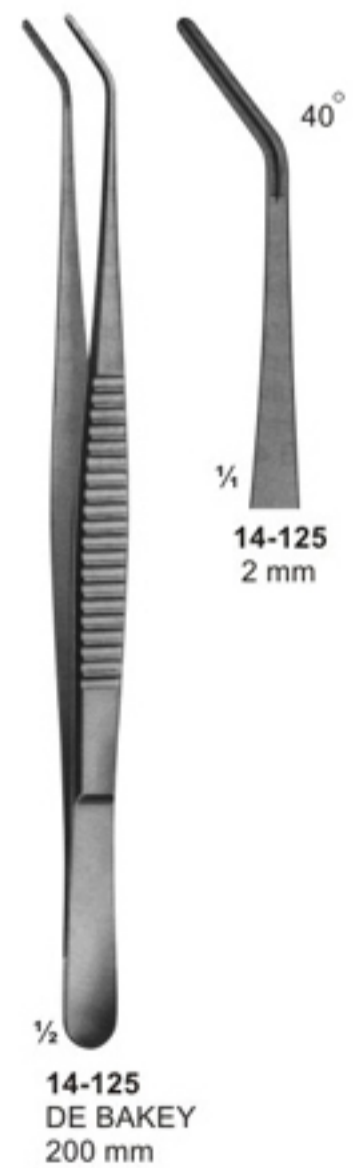
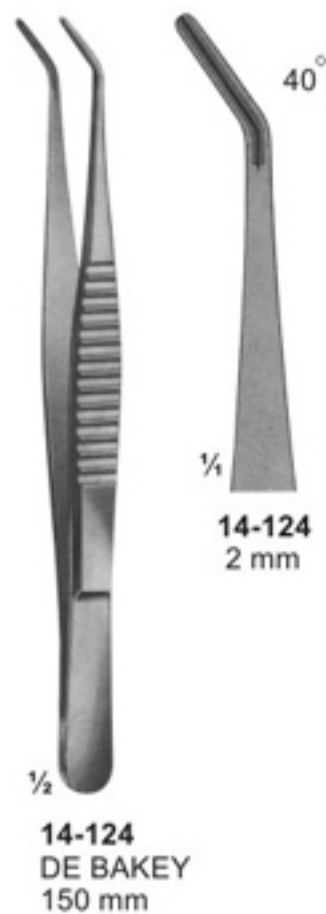
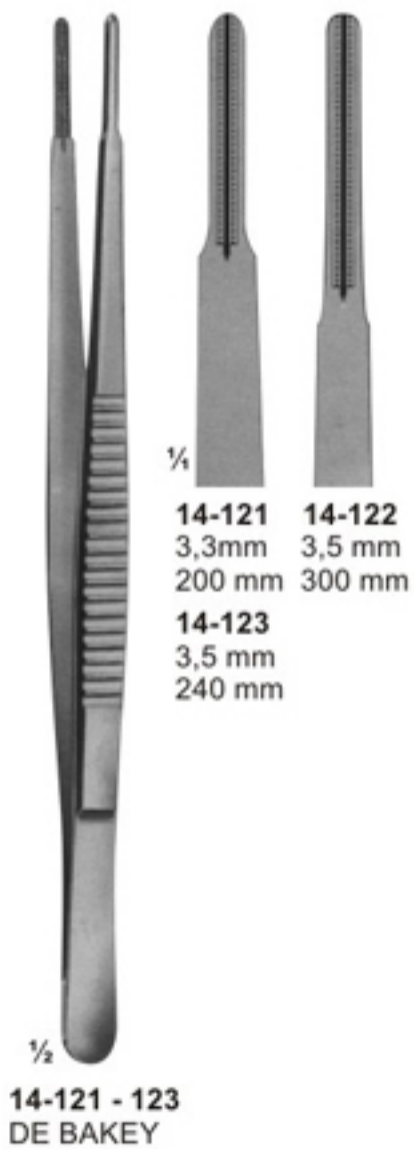
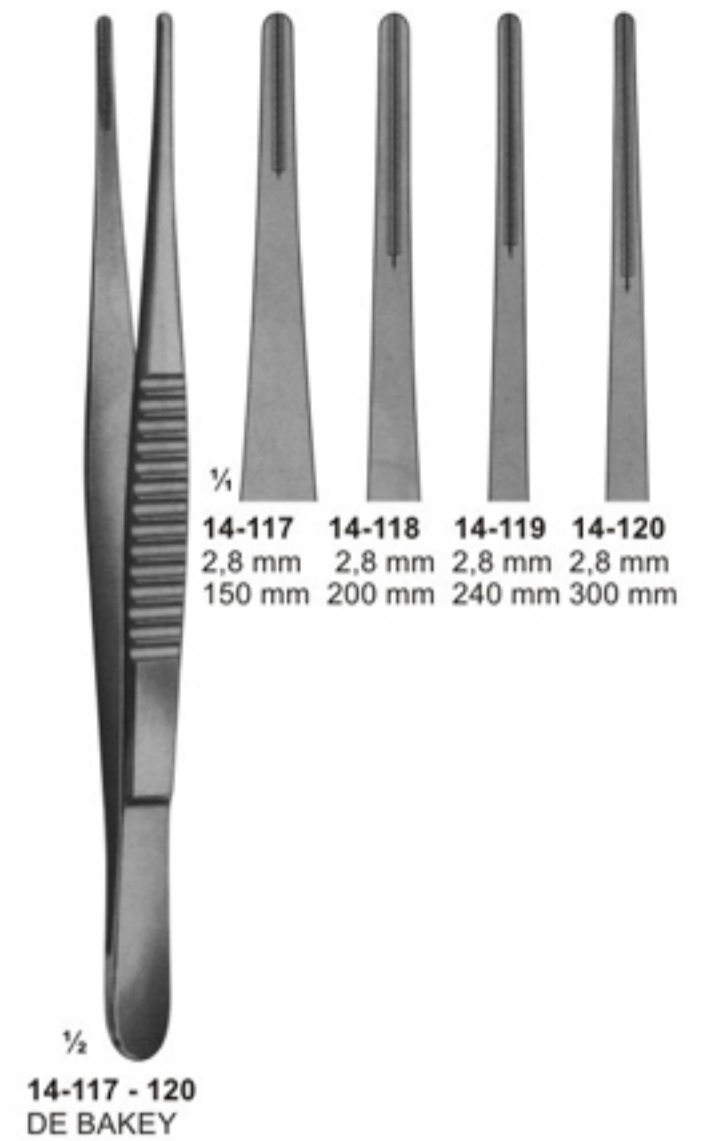
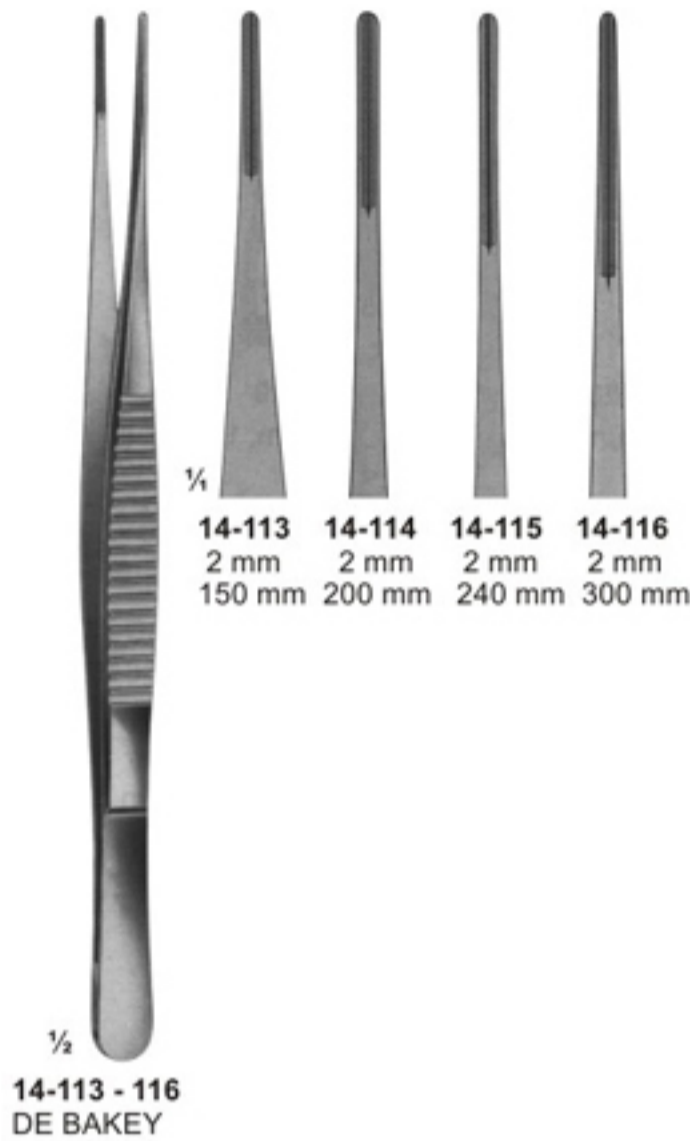
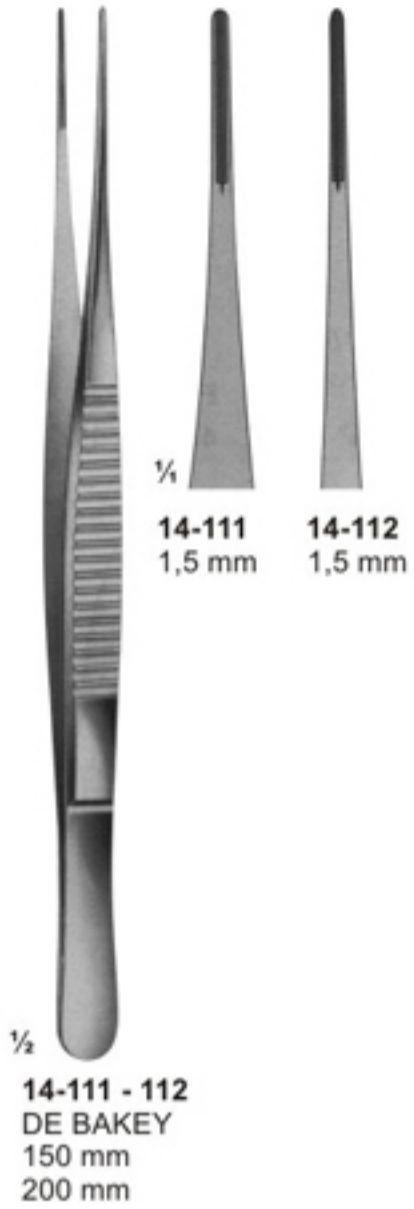
ATRAUMATA
Forceps

ATRAUMATA

Anastomosis- and Multi- Purpose- Clamps- Pediatric types

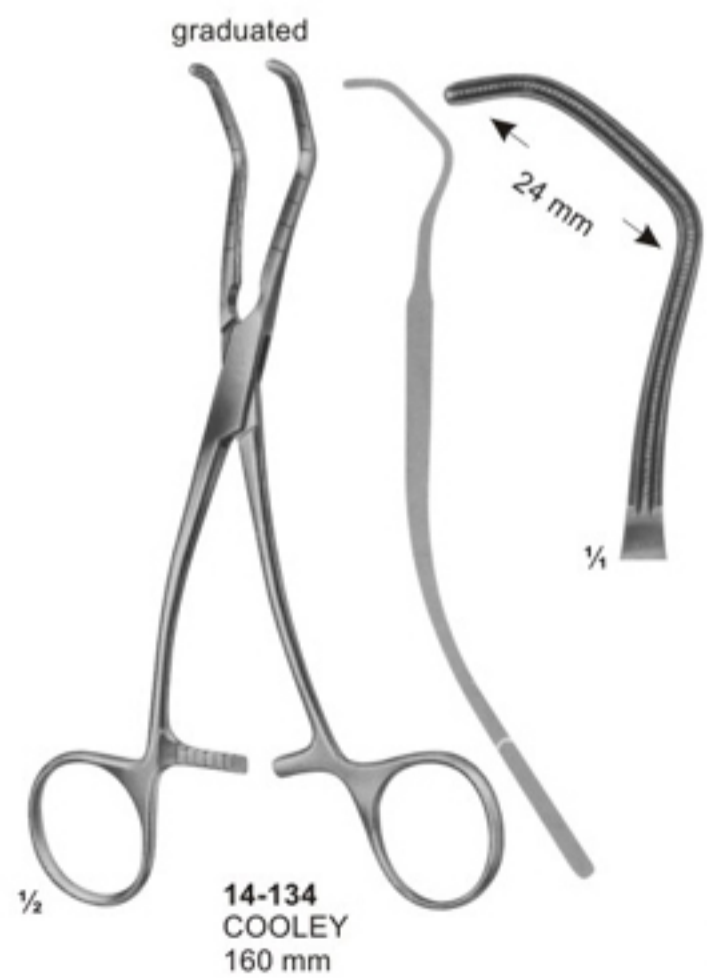
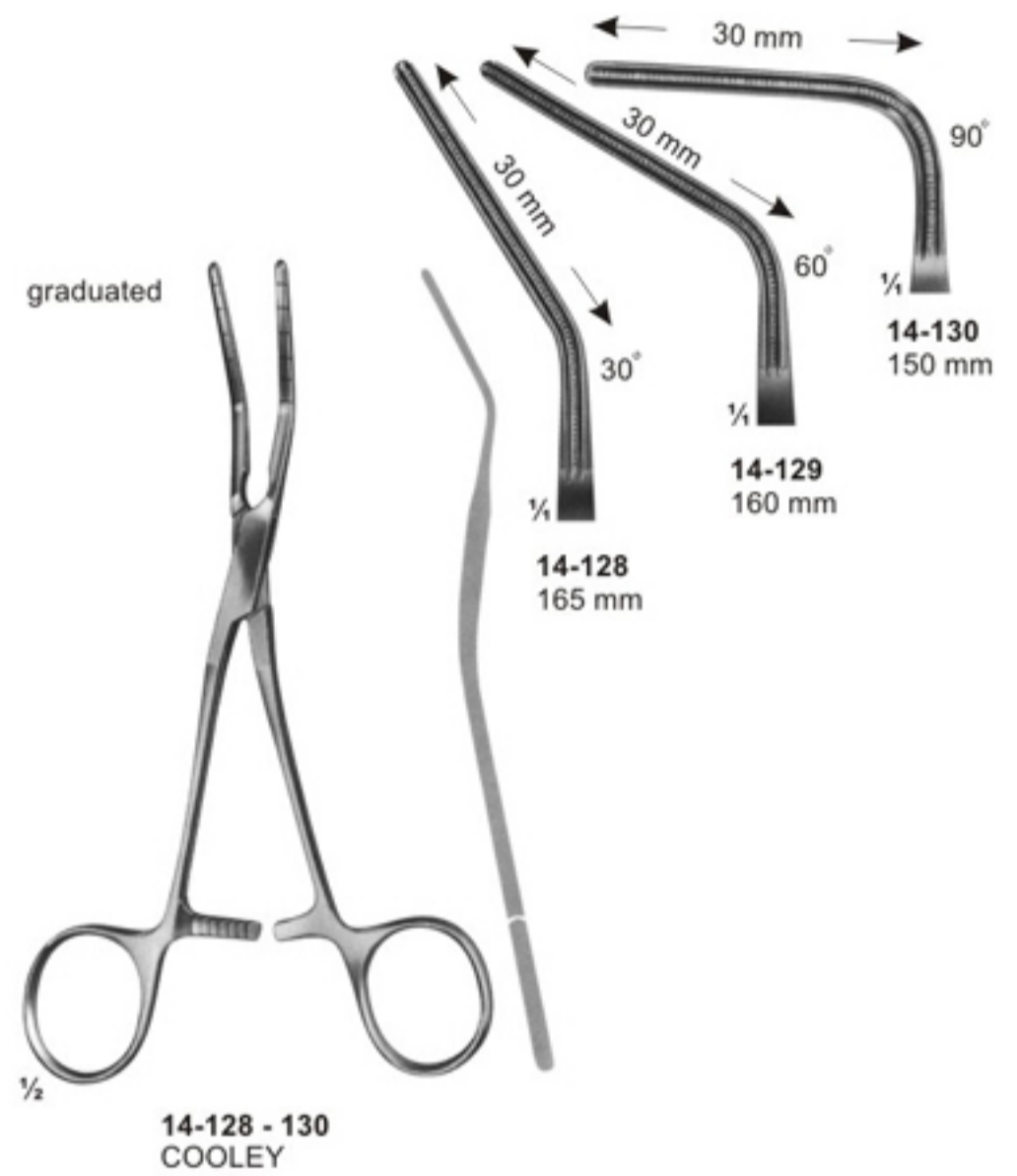
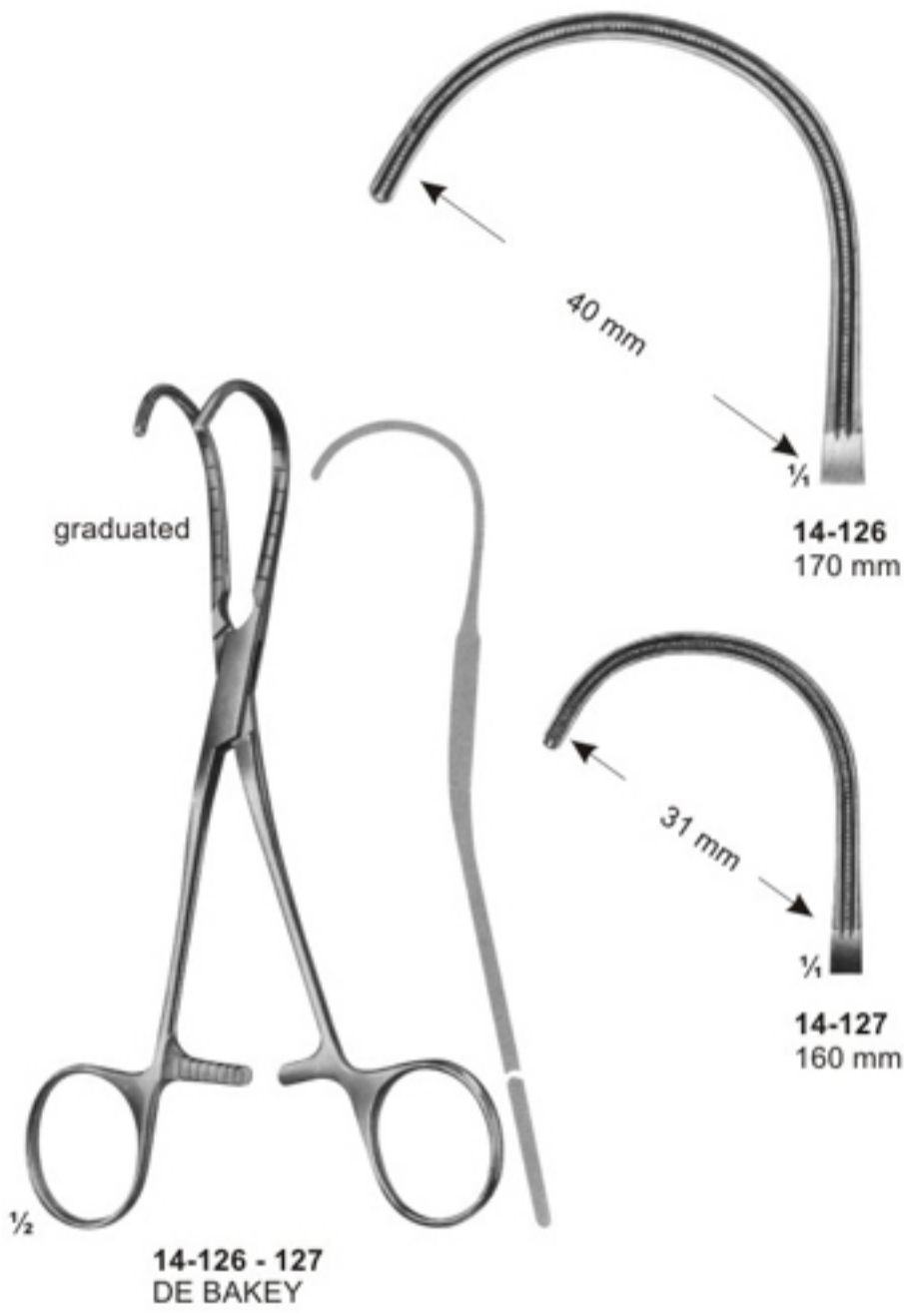

ATRAUMATA
Coarctation Clamps, Patent-Ductus & Peripheral-Vascular Clamps

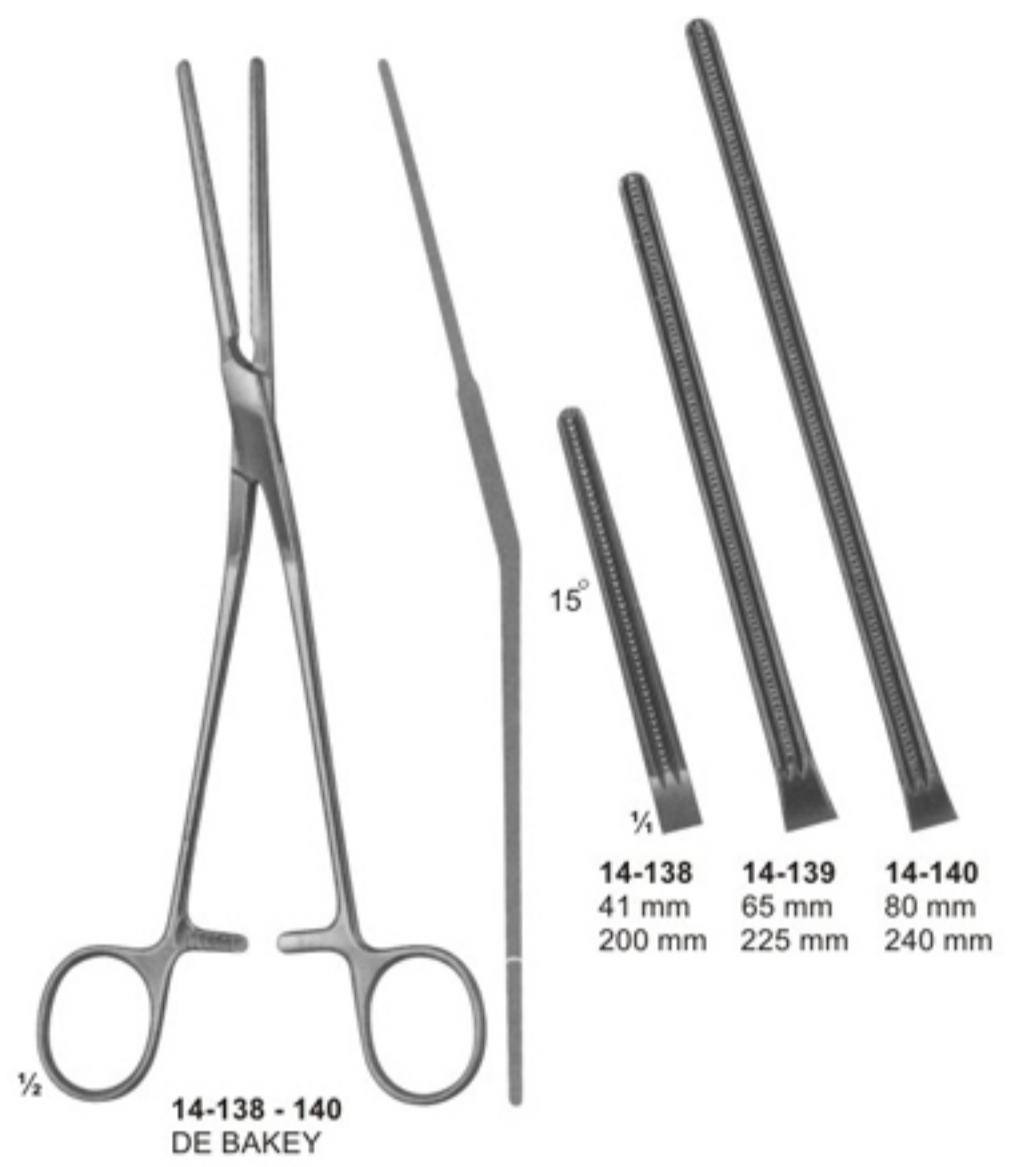

Aorta- Anastomosis Clamps



L
14-144
WEBER
260 mm

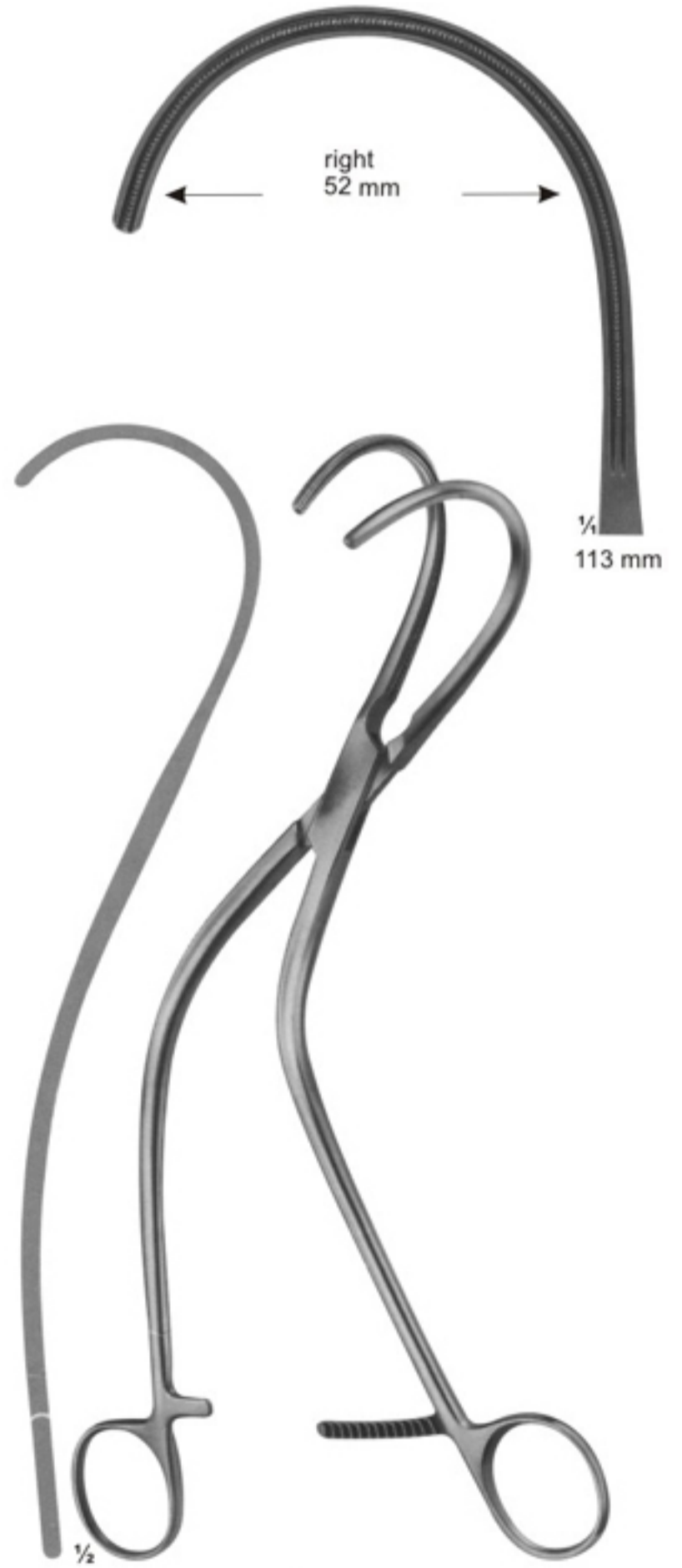

R
14-145
WEBER
260 mm

Multi- Purpose-Clamps



1/2
14-146 - 149
 DE BAKEY

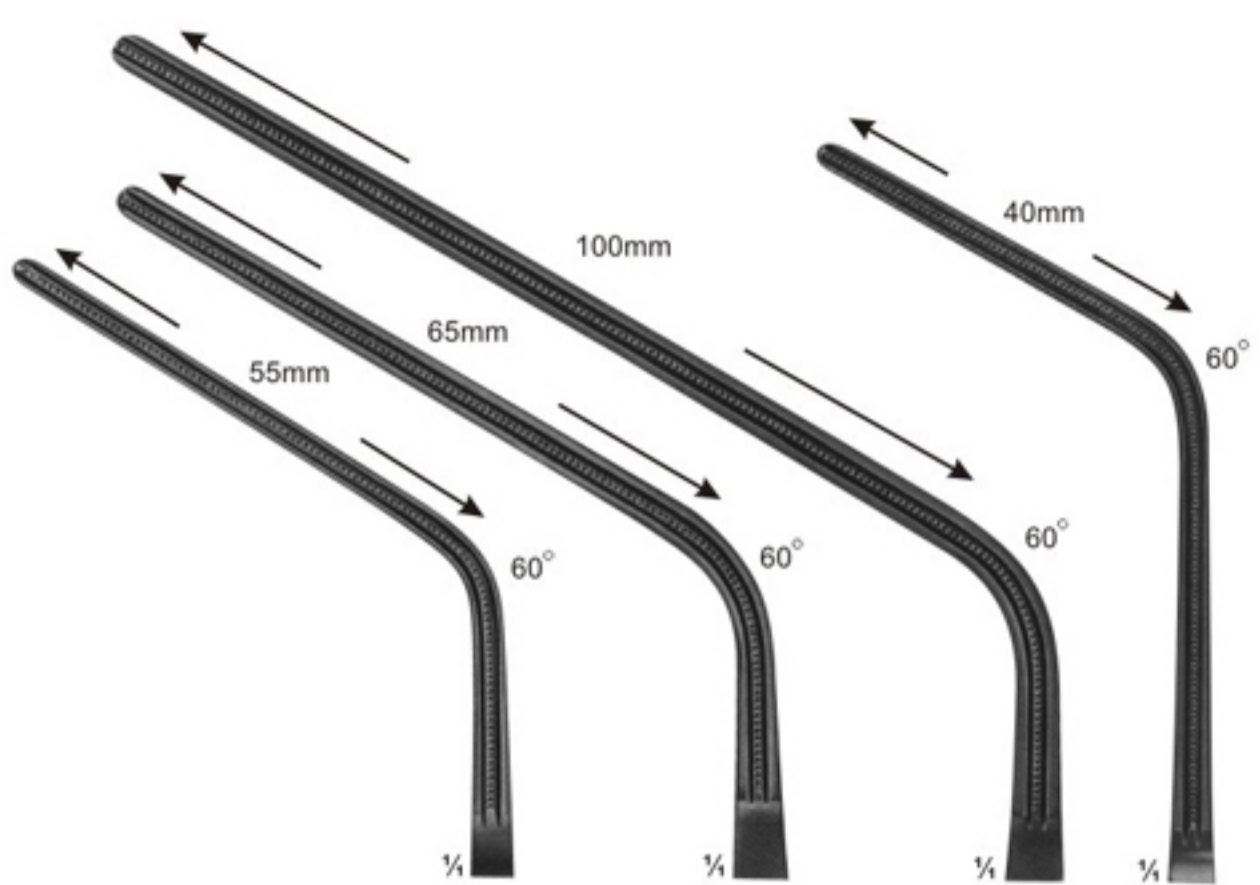

14-146 **14-147** **14-148** **14-149**

Total Length:	230 mm	280 mm	305 mm	240 mm
Length of jaws:	85 mm	100 mm	135 mm	93 mm



1/2
14-150 - 153
 DE BAKEY

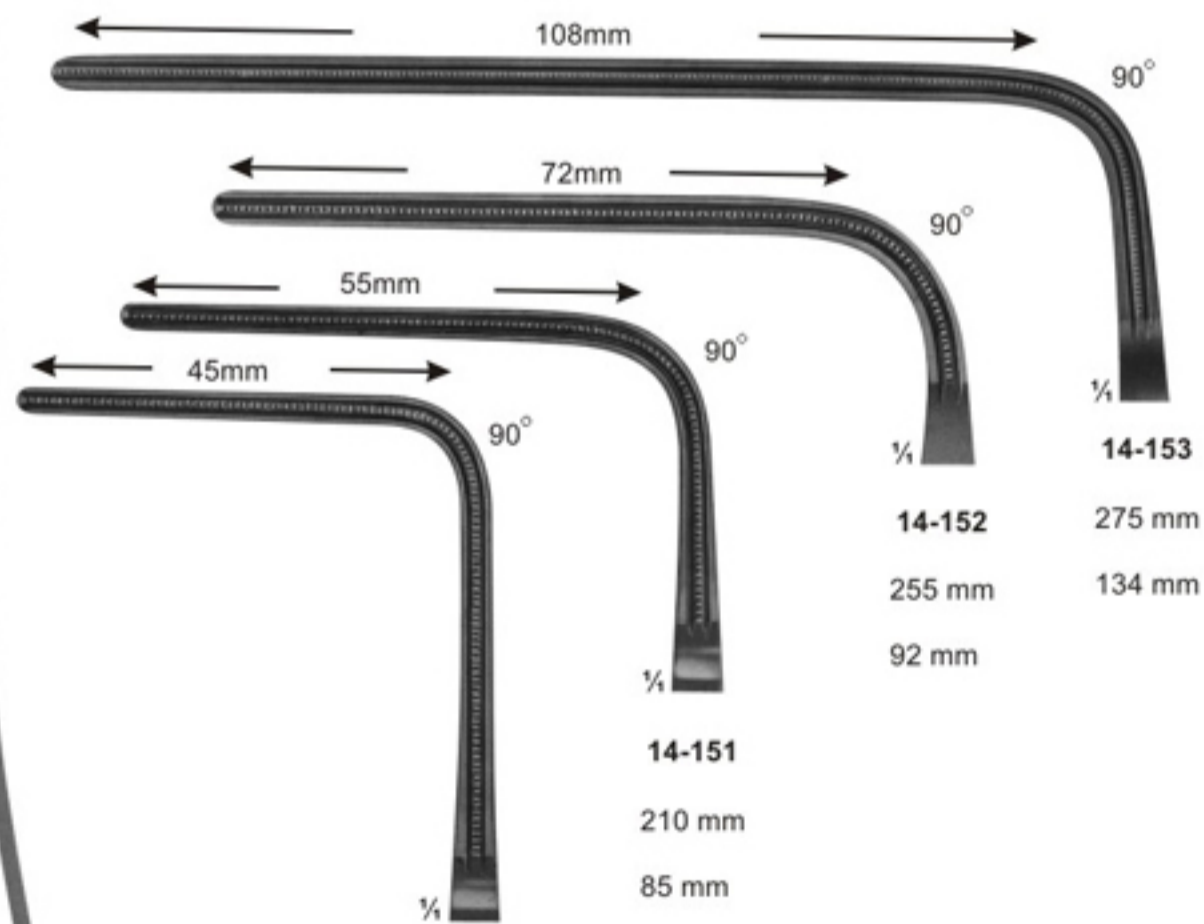

14-150 **14-151** **14-152** **14-153**

Total Length:	225 mm	255 mm	275 mm	
Length of jaws:	85 mm	92 mm	134 mm	

Sternum Instruments and Rib Shears



14-154
SCHUMACHER
Sternum shears
210 mm



14-155
LEBSCHKE
Sternum chisel
200 mm



14-156
230 mm



14-157
COLLIN
195 mm



14-158
GLUCK
190 mm



14-159
BETHUNE
340 mm



14-160
BRUNNER
Universal pattern
340 mm



14-161
GIERTZ-STILLE
250 mm

Rib Spreaders

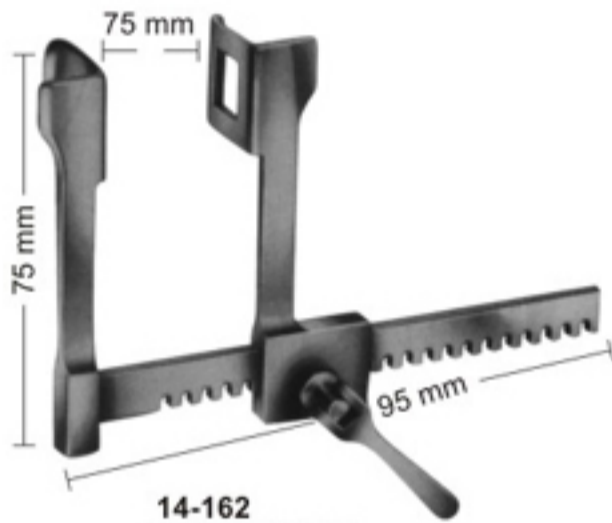

14-162
FINOCHIETTO
Blades
18X21 mm

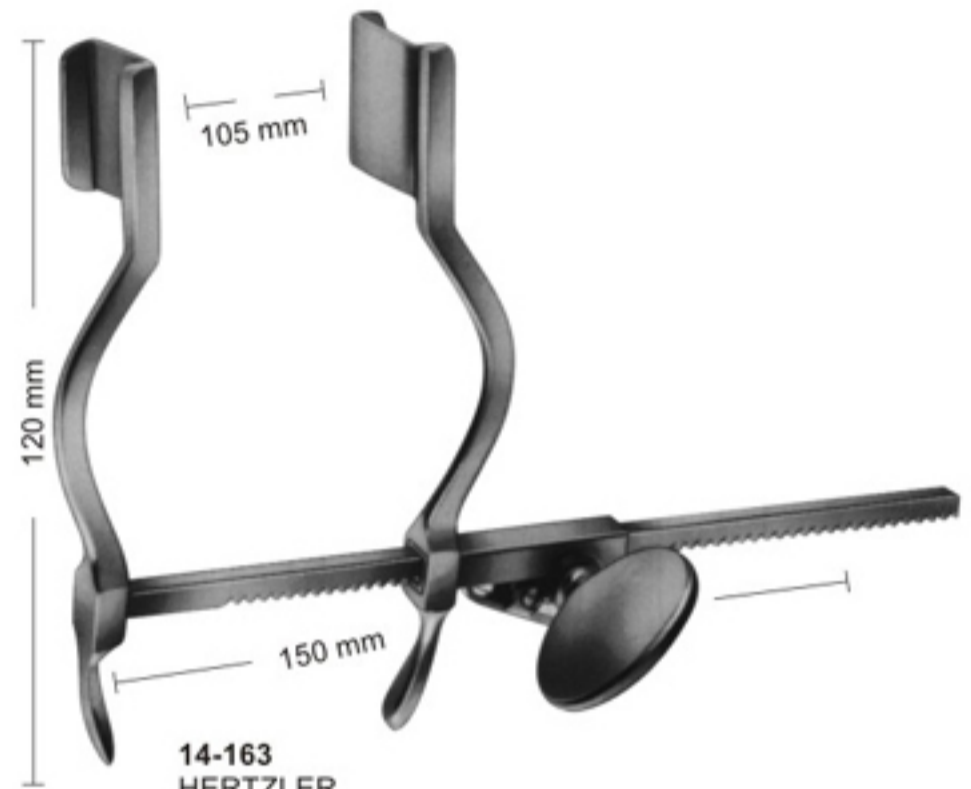

14-163
HERTZLER
Blades
20X25 mm

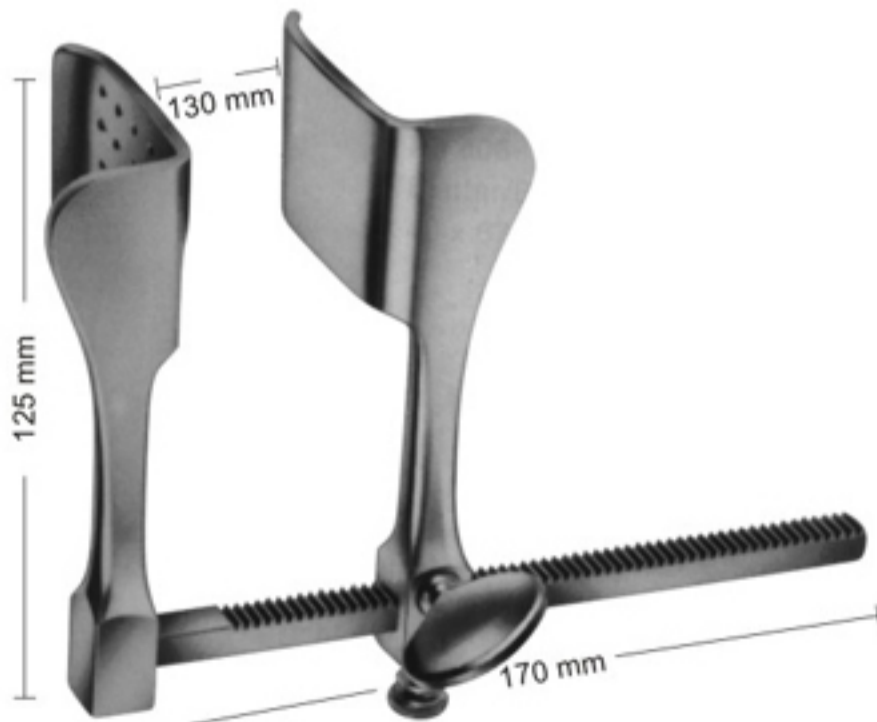

14-164
TUFFIER
Blades
43X53 mm

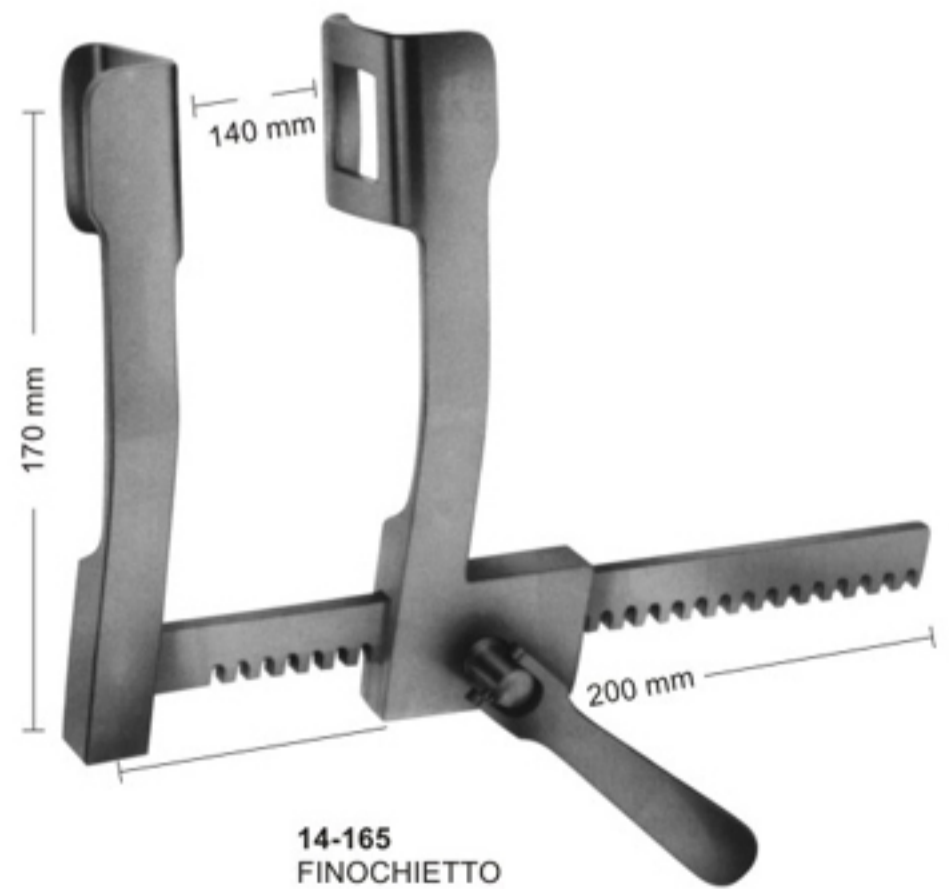

14-165
FINOCHIETTO
Blades
36X45 mm

Rib Spreaders-and Contractors



14-166
SELLORS
Rib spreader-and contractor
with swivel blades
200 mm



14-167
BAILEY
150 mm



14-168
for children

14-169
for adults

14-168 - 169
BAILEY
200 mm

Punches

130° upwards cutting

15-101
1 mm 
KERRISON - JACOBY

FERRIS-SMITH-KERRISON

15-102
2 mm 

15-103
3 mm 

15-104
4 mm 

15-105
5 mm 

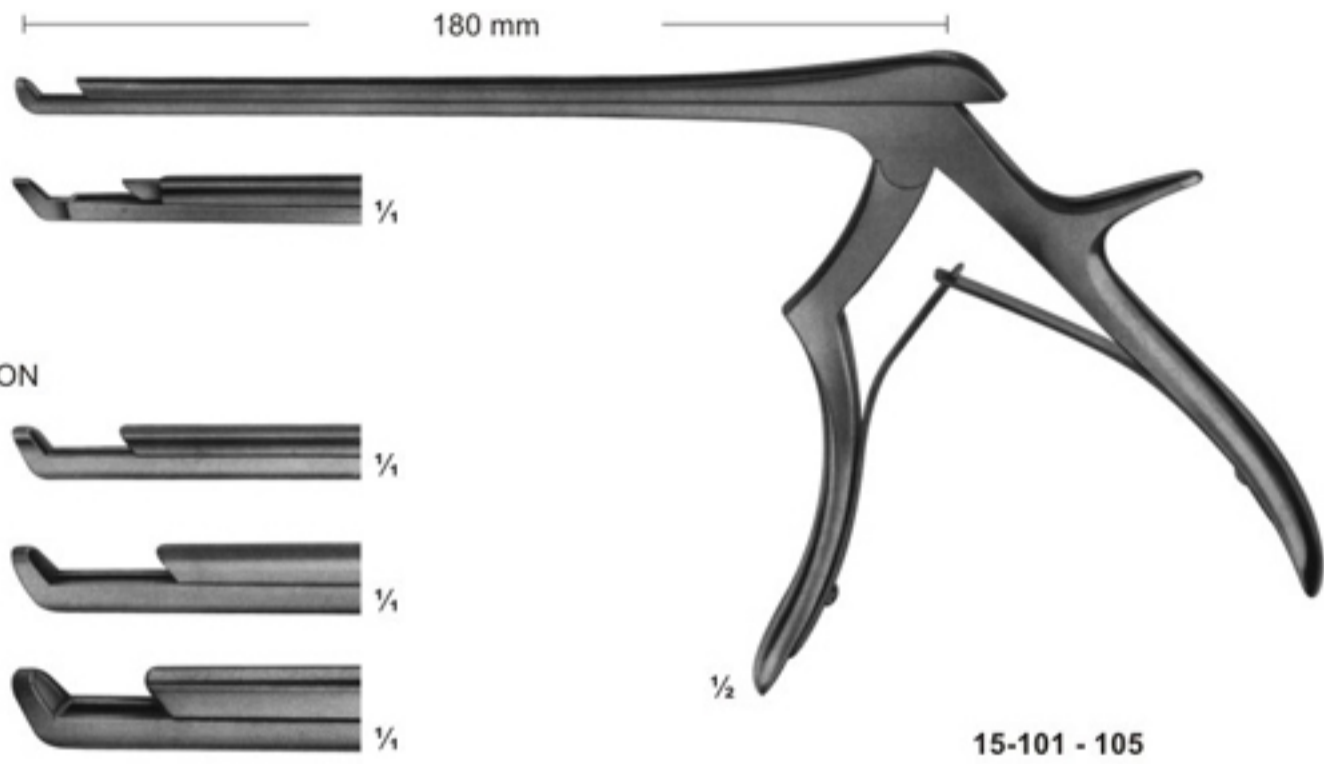

15-101 - 105

90° upwards cutting

KERRISON - JACOBY

15-106
1 mm 

15-107
2 mm 

FERRIS-SMITH-KERRISON

15-108
3 mm 

15-109
4 mm 

15-110
5 mm 

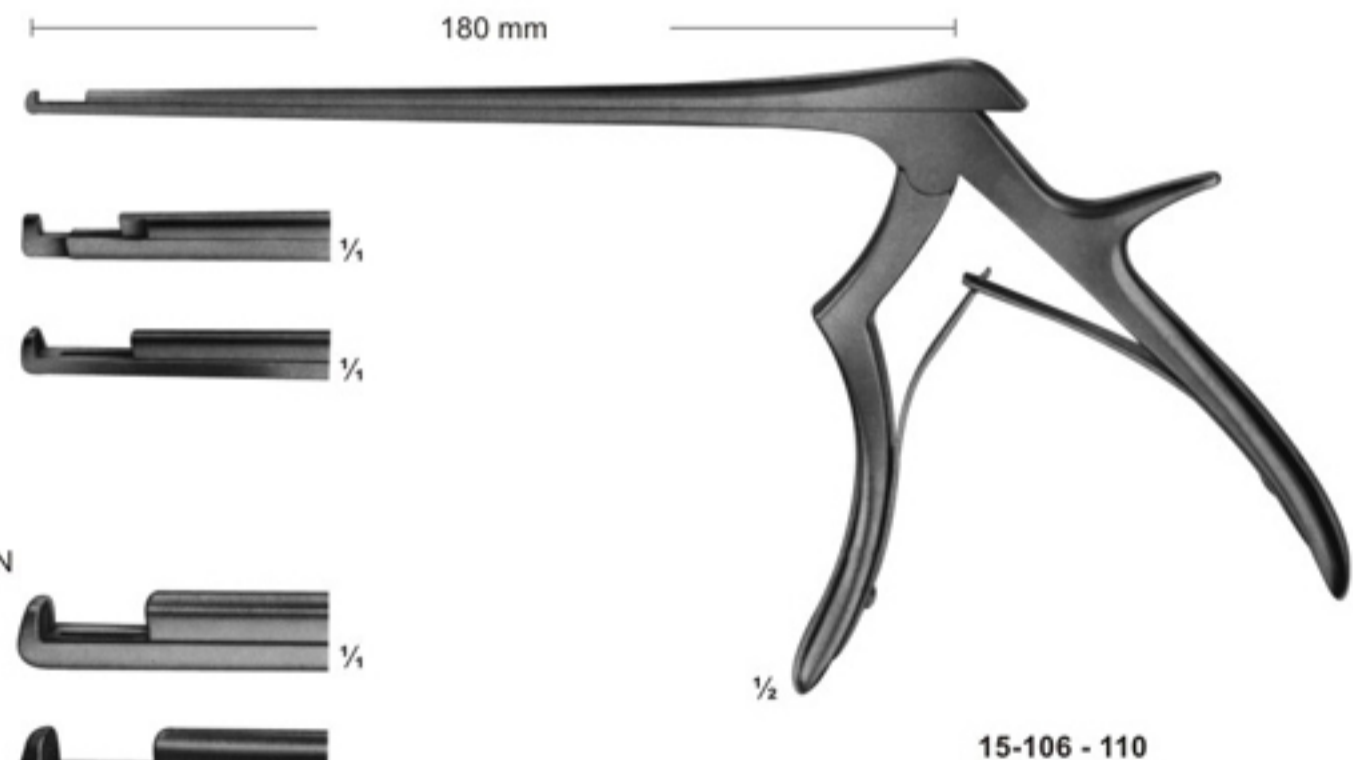

15-106 - 110

Punches

90° upwards cutting

85 mm

15-111
4 mm



15-112
5 mm

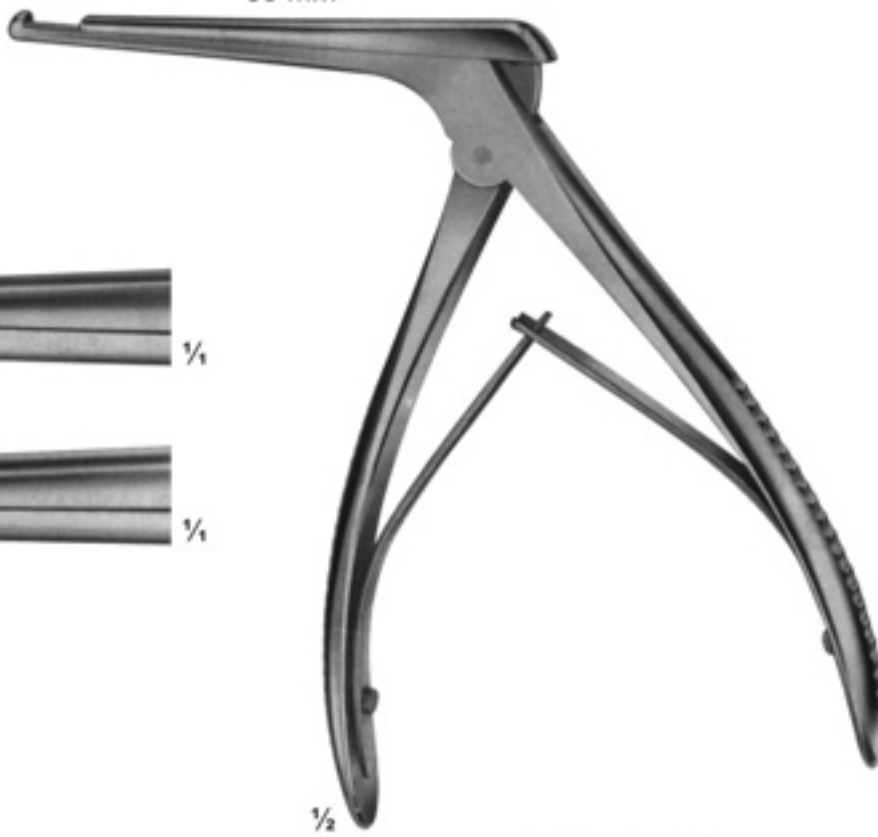

15-111 - 15-112
KERRISON

90° upwards cutting

140 mm

15-113
3,3 mm



15-114
4,0 mm

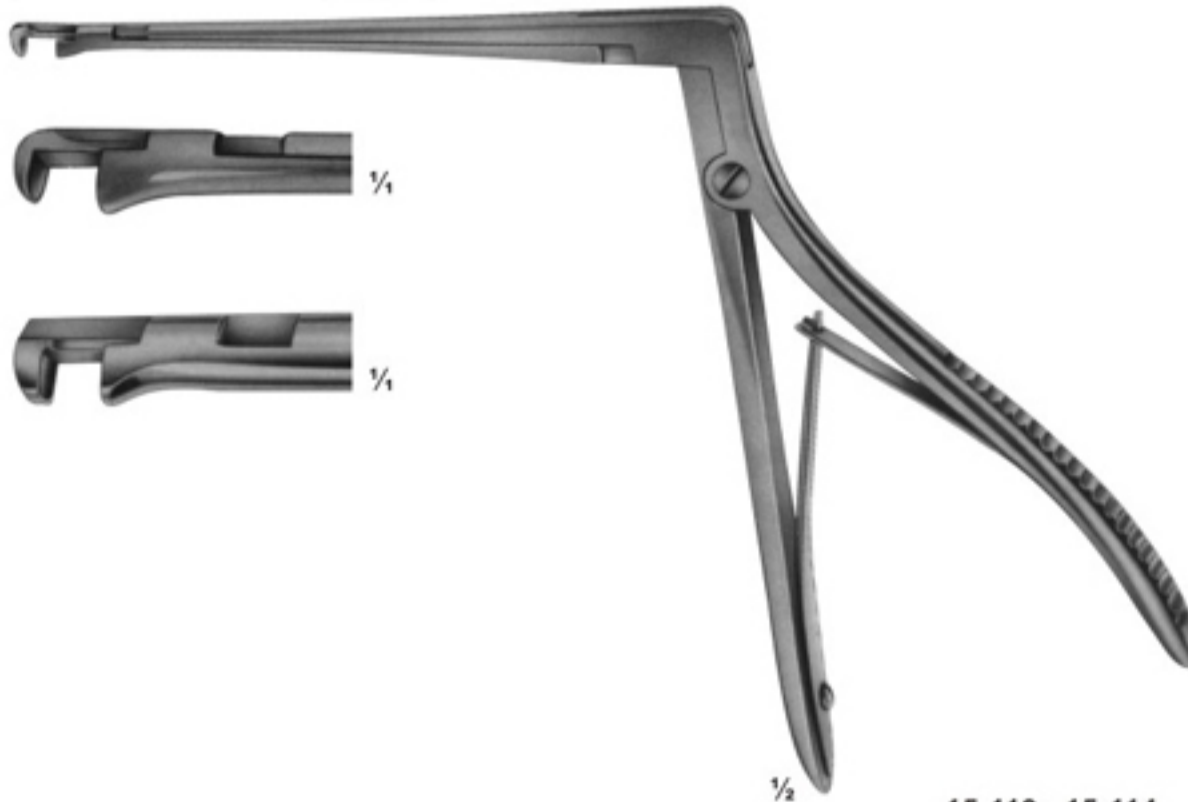

15-113 - 15-114
HAJEK-KOFLER

Rongeurs

LOVE-GRUENWALD

15-115
2 X 10 mm



15-116
3 X 10 mm



SPURLING

15-117
4 X 10 mm



15-115 - 15-117

15-118
2 mm



15-119
3 mm



15-120
4 mm



15-121
5 mm

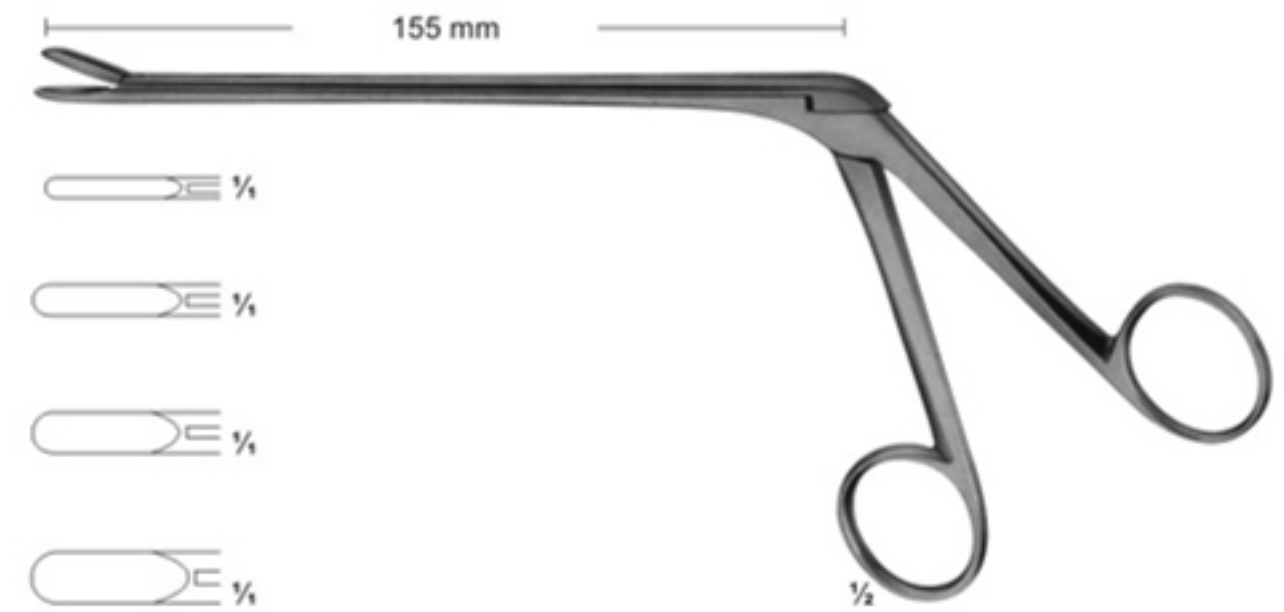

15-118 - 15-121
CASPAR

150°

15-122
2 mm



15-123
3 mm



15-124
4 mm

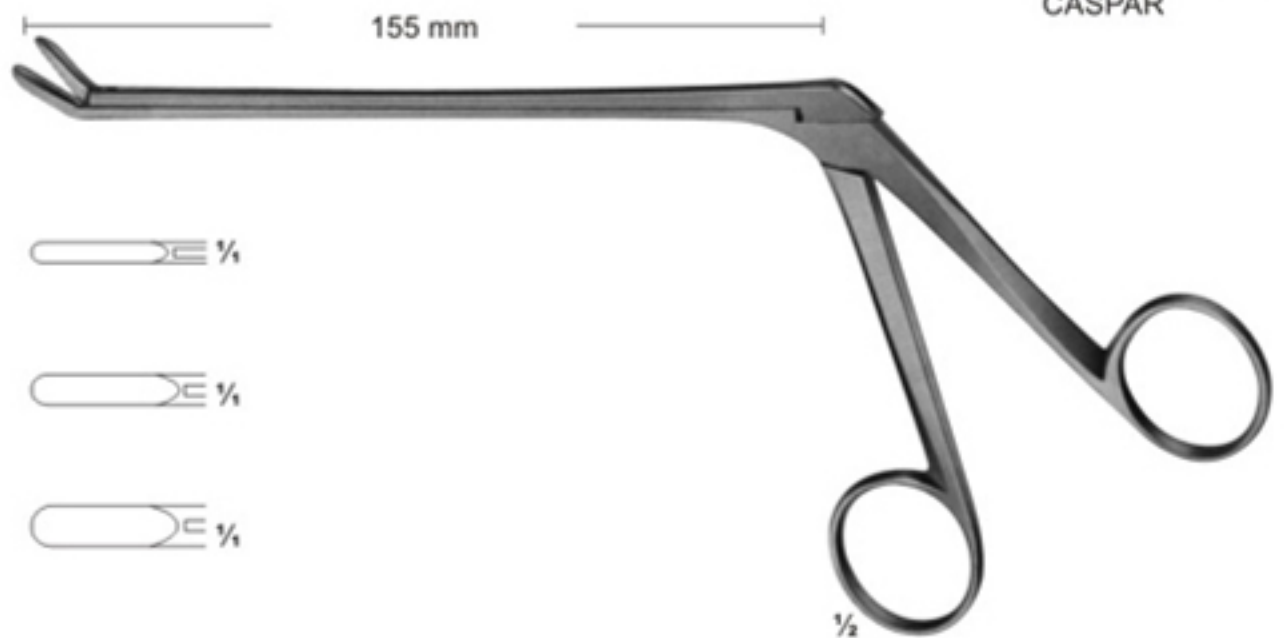

15-122 - 15-124
CASPAR

Rongeurs

Angled positions for rongeurs

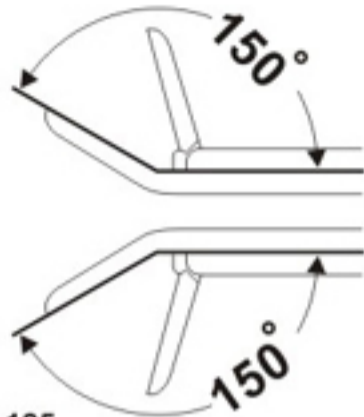

- 15-125
3,0 mm
- 15-126
3,6 mm
- 15-127
4,2 mm
- 15-128
4,8 mm
- 15-129
5,8 mm

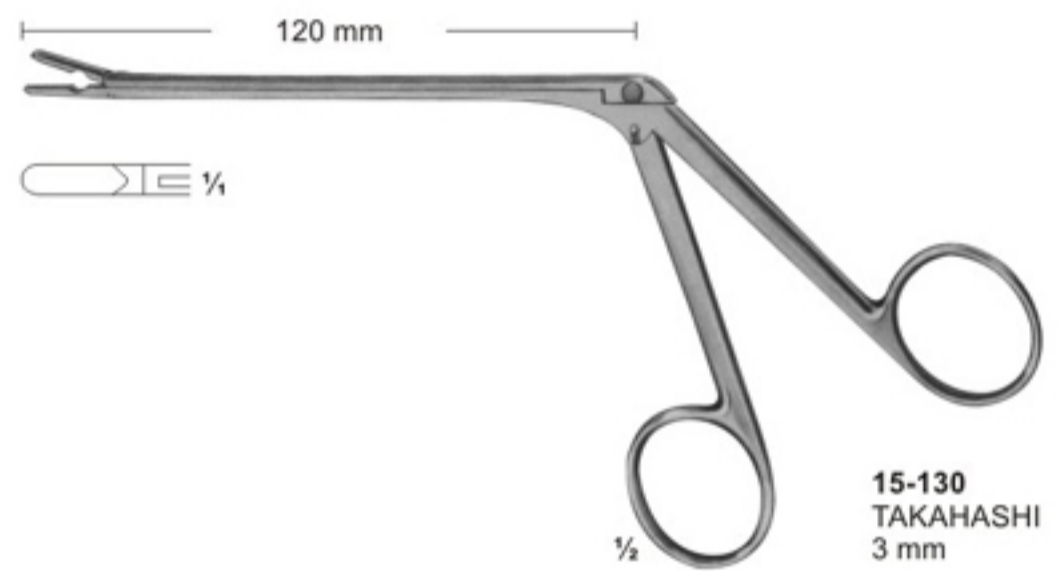
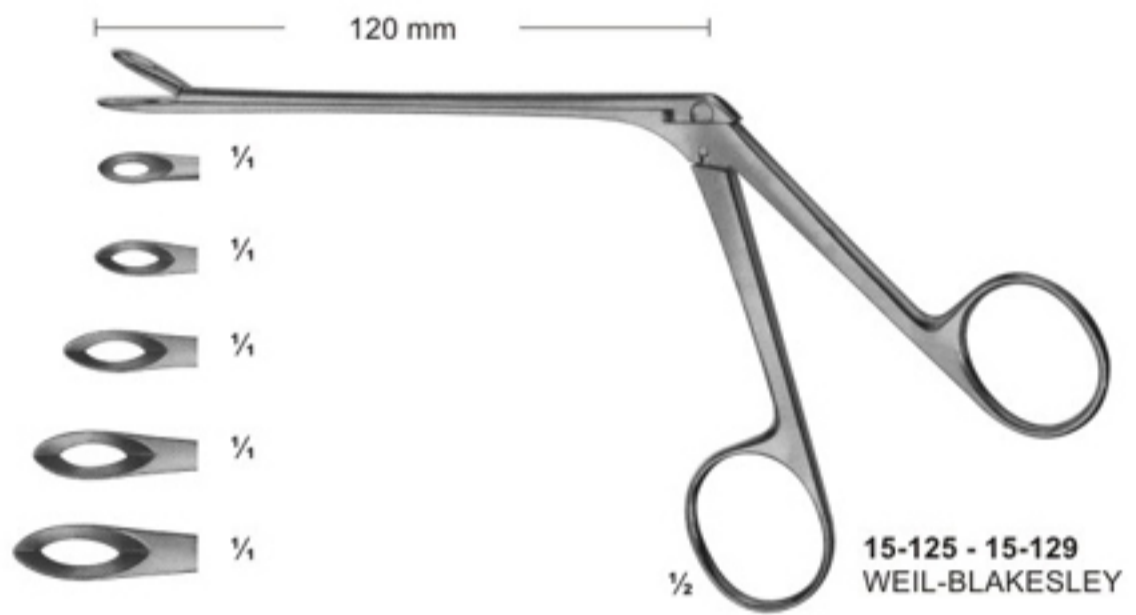
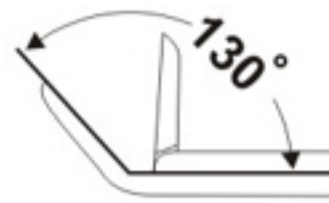
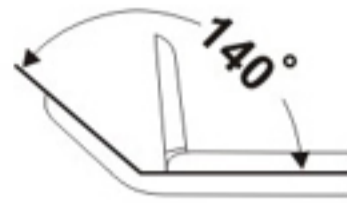

130°

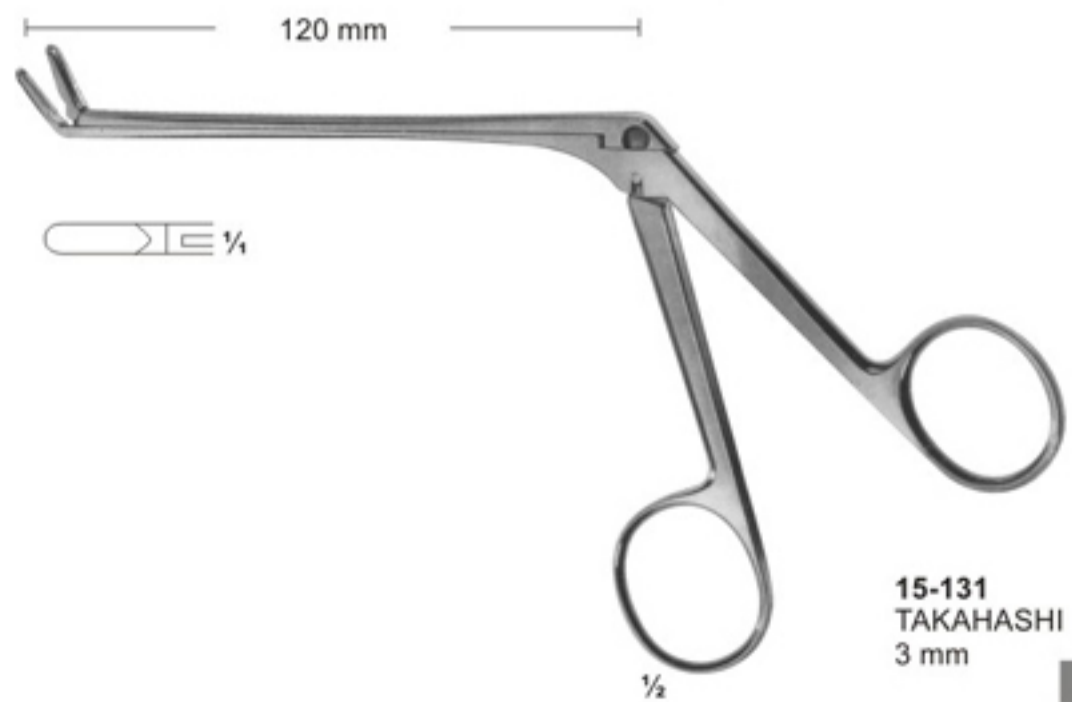

Rongeurs

150°

Lower part of jaws movable

15-132
2 mm



15-133
3 mm



15-134
4 mm

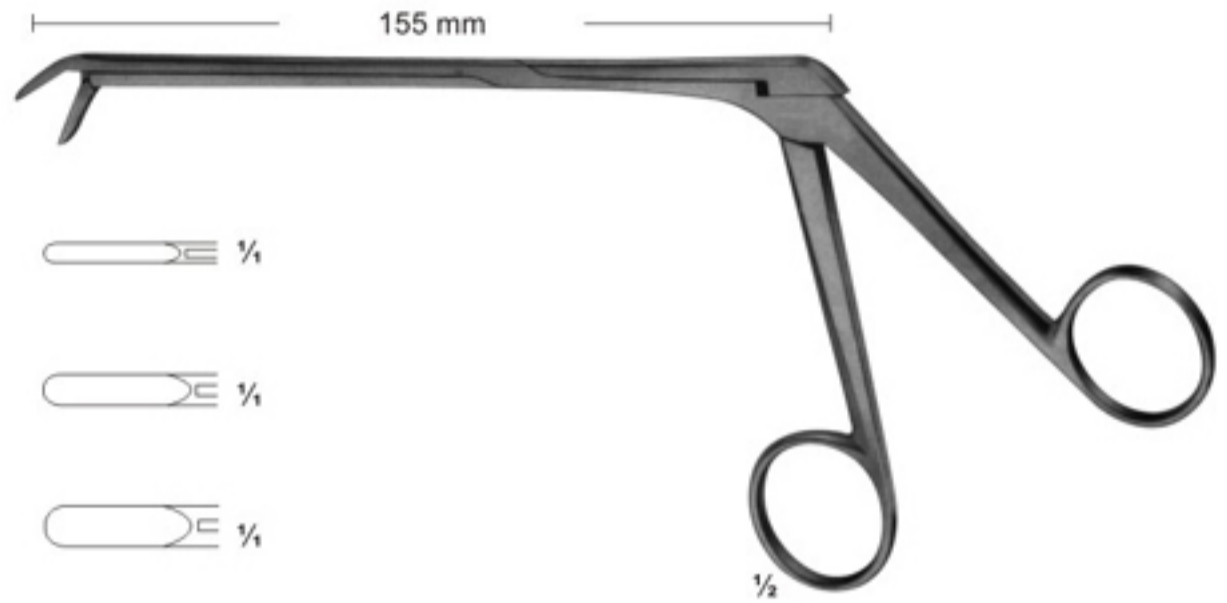

15-132 - 15-134
CASPAR

Length of shaft 140 mm	Length of shaft 160 mm	Length of shaft 185 mm	size of jaws
15-135	15-140	15-145	2 X12 mm
15-136	15-141	15-146	3 X12 mm
15-137	15-142	15-147	4 X14 mm
15-138	15-143	15-148	5 X14 mm
15-139	15-144	15-149	6 X16 mm

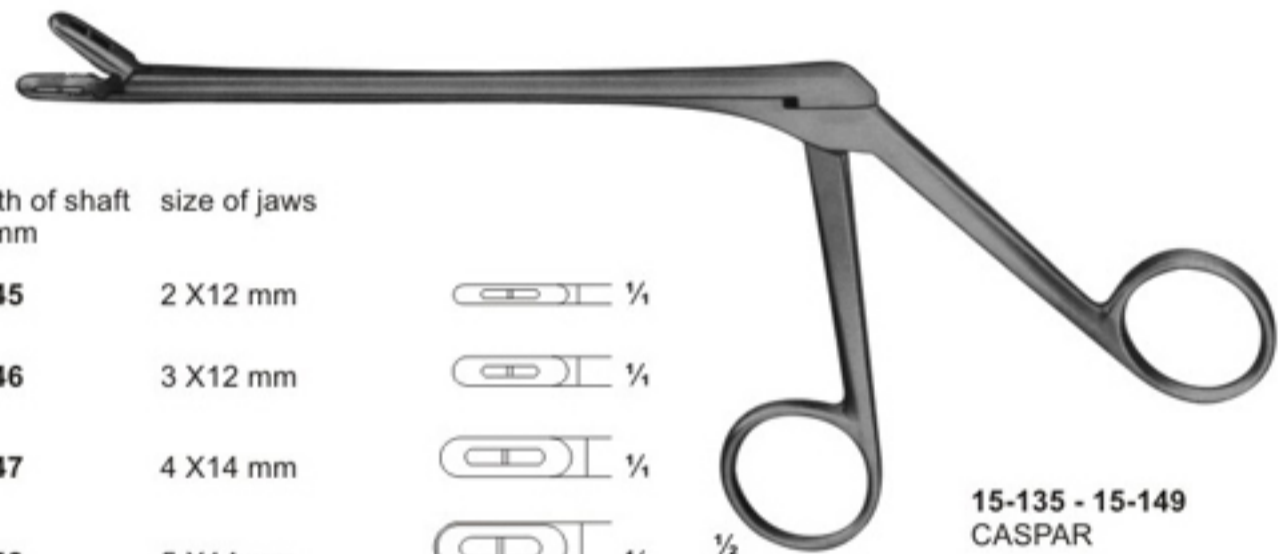
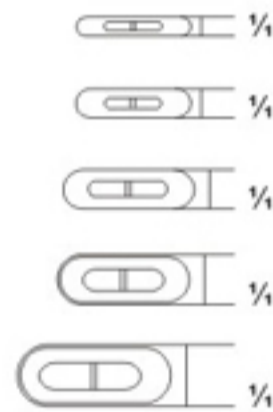

15-135 - 15-149
CASPAR

150°

Length of shaft 140 mm	Length of shaft 160 mm	Length of shaft 185 mm	size of jaws
15-150	15-153	15-156	3 X12 mm
15-151	15-154	15-157	4 X14 mm
15-152	15-155	15-158	5 X14 mm

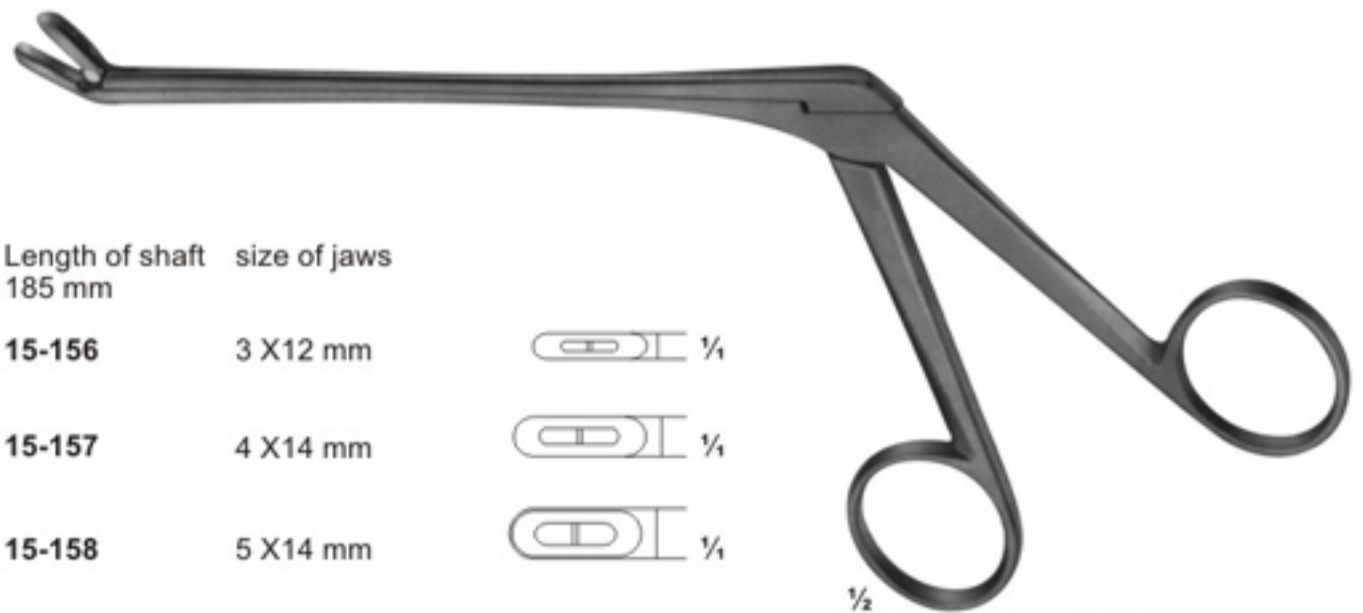
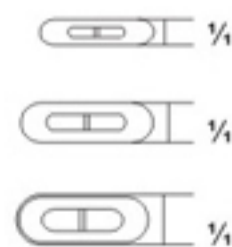

15-150 - 15-158
CASPAR

Rongeurs

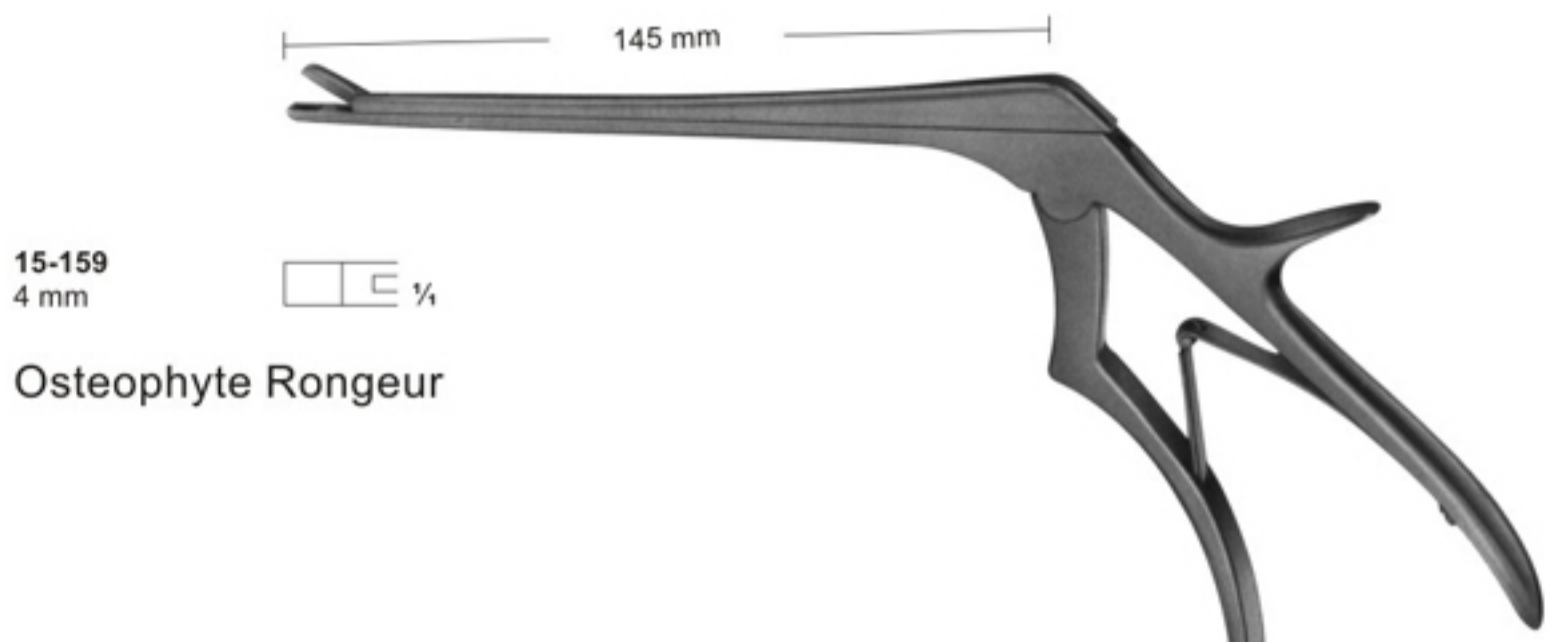

15-159
4 mm
Osteophyte Rongeur

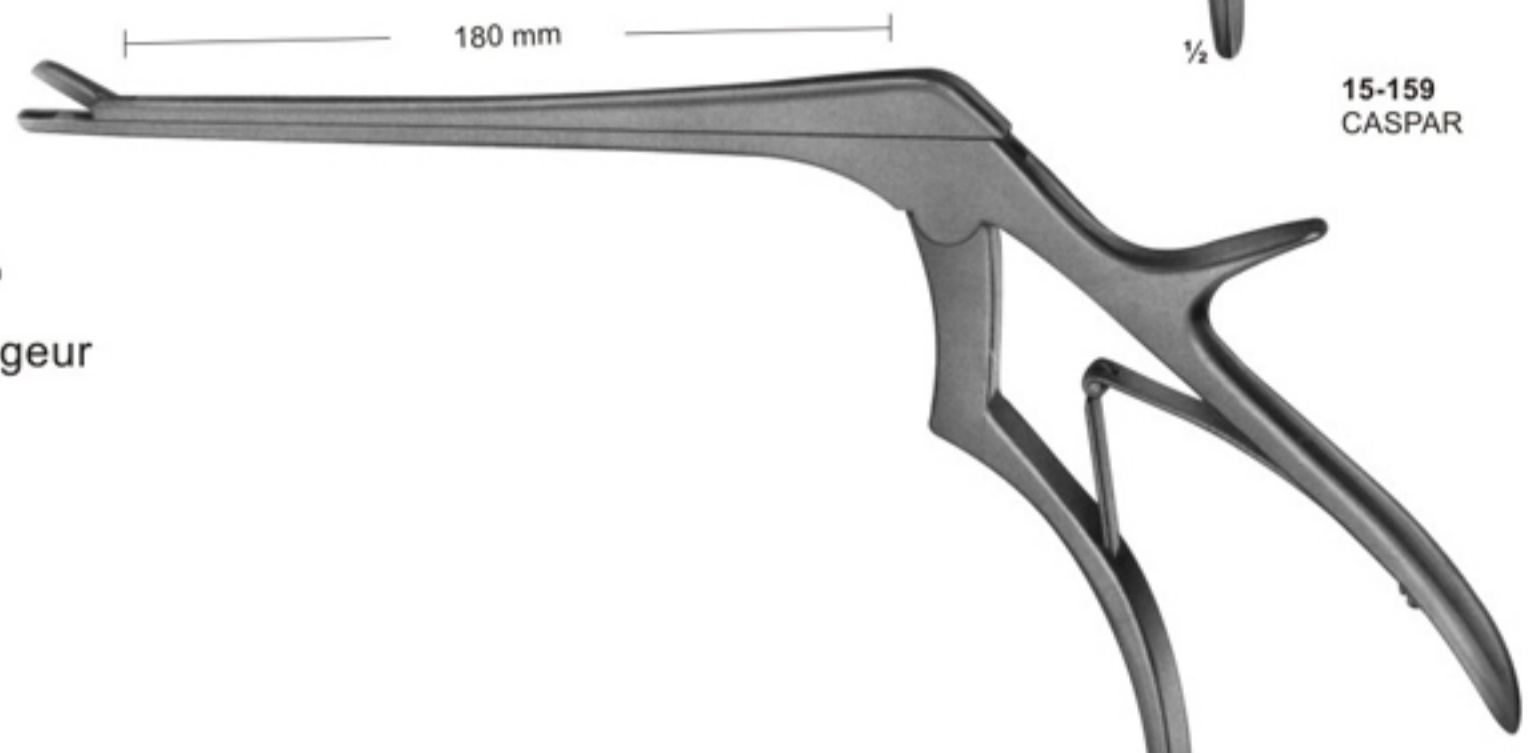

15-160
4 mm
Osteophyte Rongeur

15-159
CASPAR

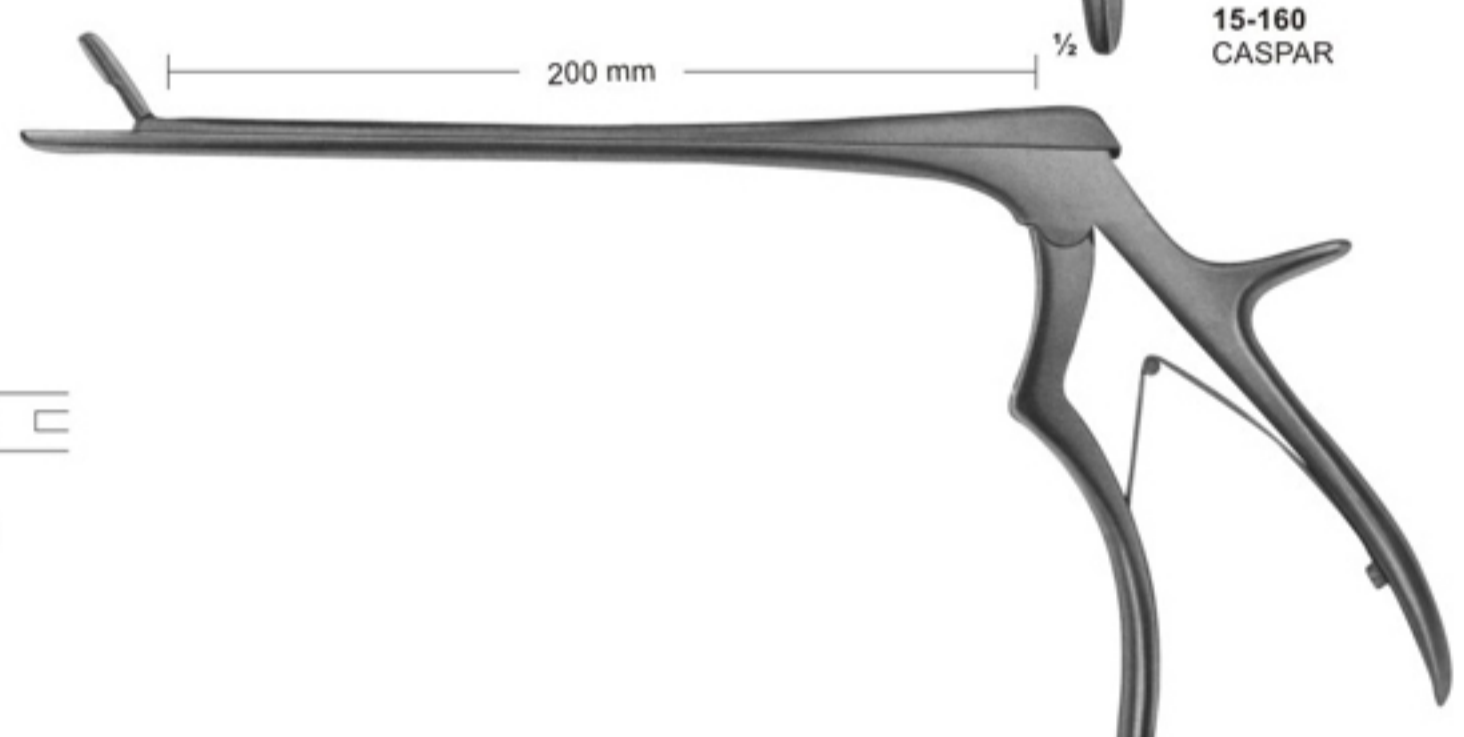

15-161
5,5 mm
Very Heavy Pattern

15-160
CASPAR

15-161
WAGNER

Elevators and Bone Levers

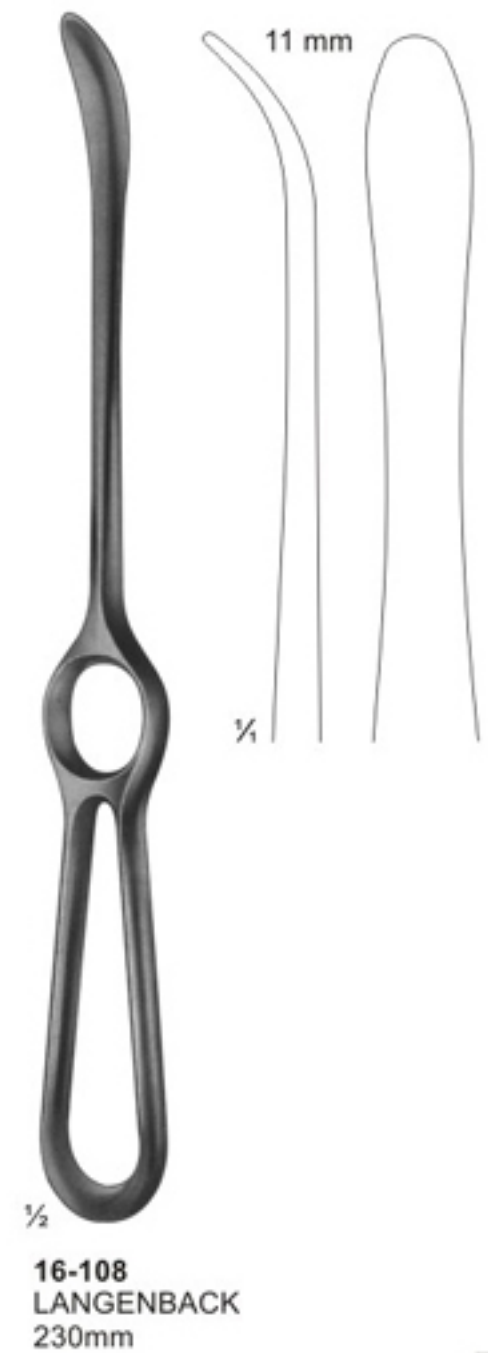
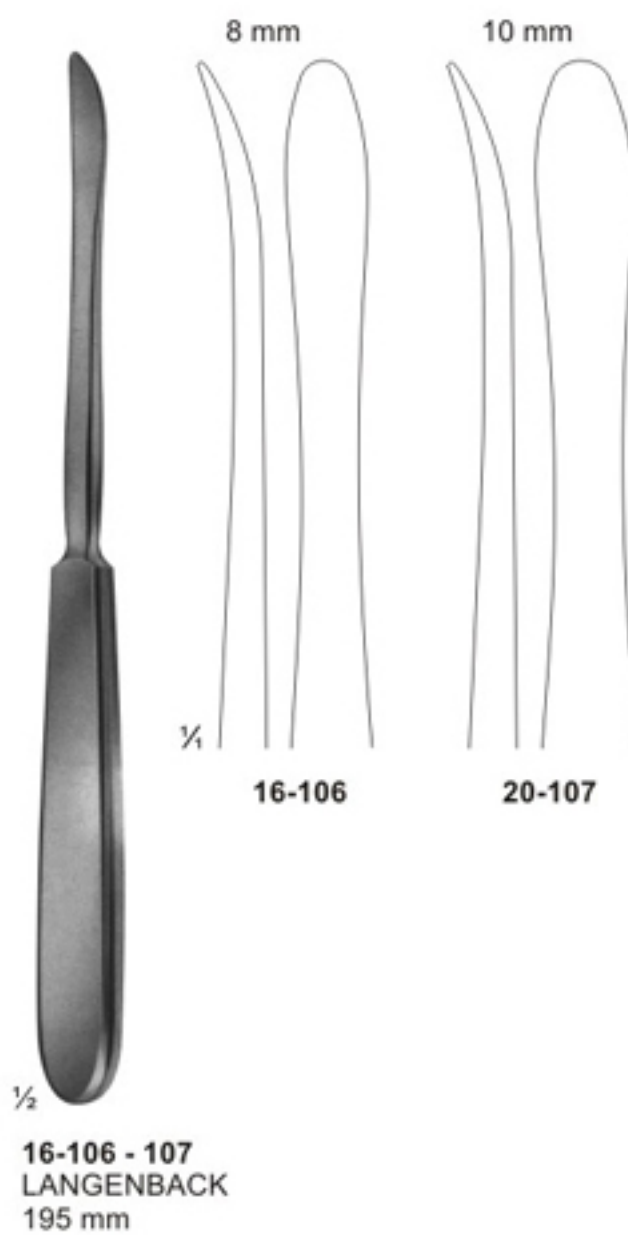
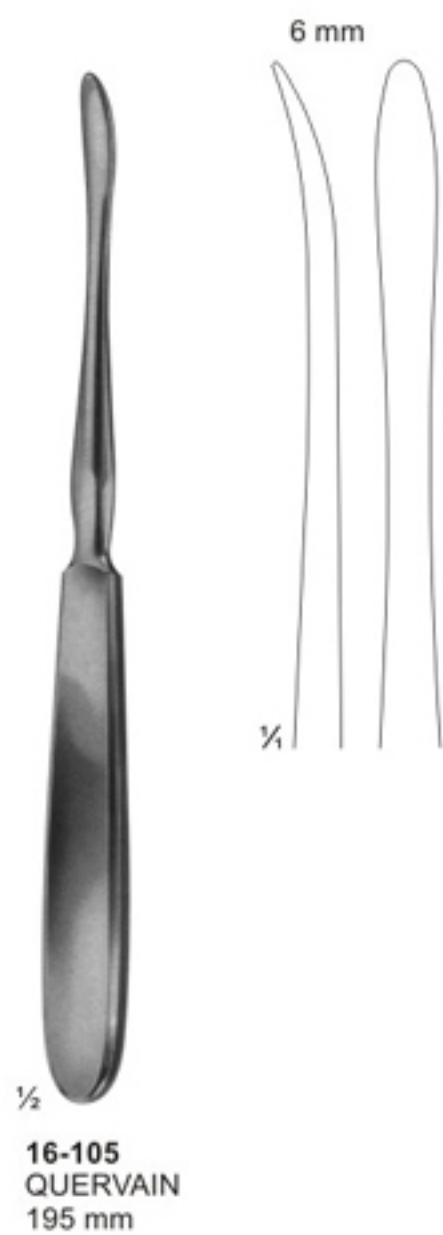
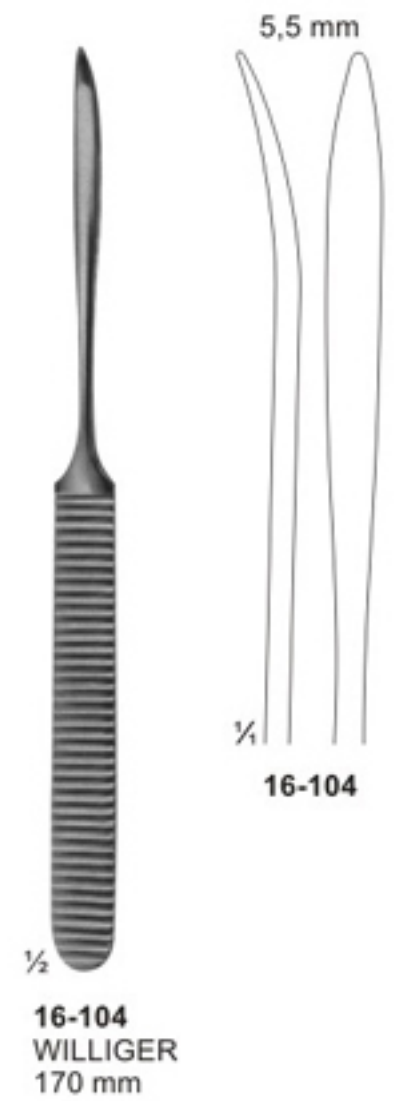
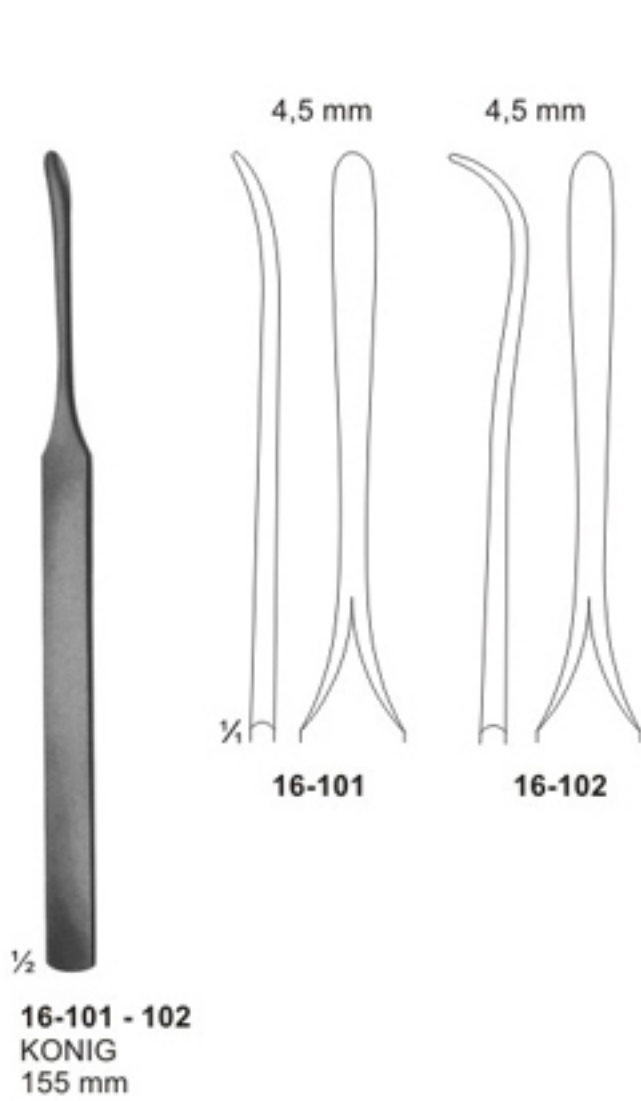

Bone Levers



$\frac{1}{2}$
16-109
LANE TRETOWAN
215mm

$\frac{1}{2}$
16-110
LANE
255mm

$\frac{1}{2}$
16-111
LANGE-HOHMANN
250mm

$\frac{1}{2}$
16-112 - 113
LANGE-HOHMANN modif.
16-112 265mm
16-113 280mm

16-112
30 mm
16-113
33 mm

Raspatories



16-114
PARTSCH
150 mm

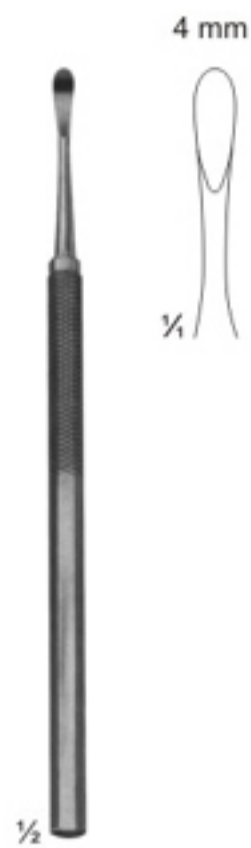

16-116
PARTSCH mod. LANGE
145 mm



16-117
MC KENTY
155 mm

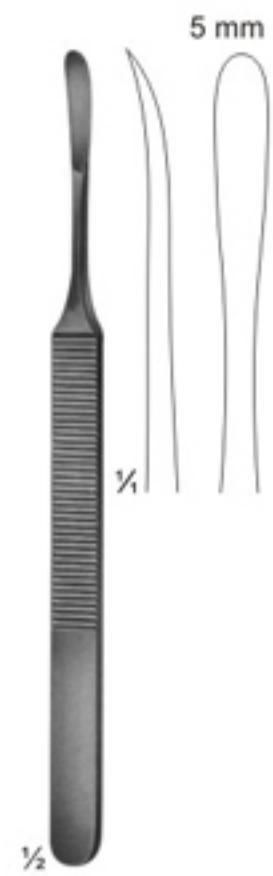

16-118
KOENIG
155 mm

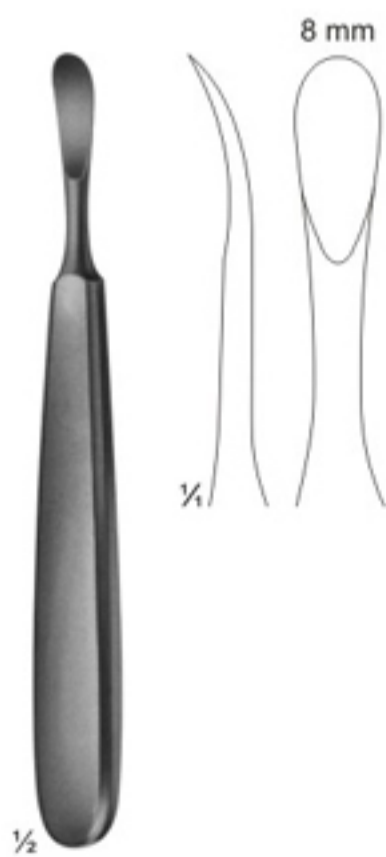

16-119
TRELAT
150 mm

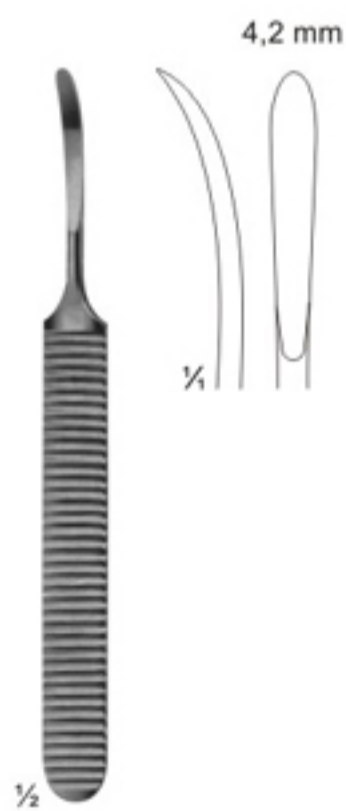

16-120
WILLIGER
140 mm



16-121
WILLIGER
160 mm

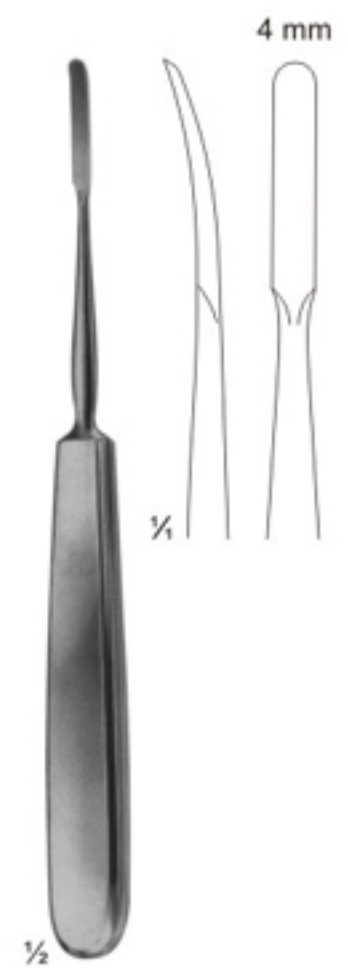

16-122
JOSEPH
170 mm

Bone File and Rasps

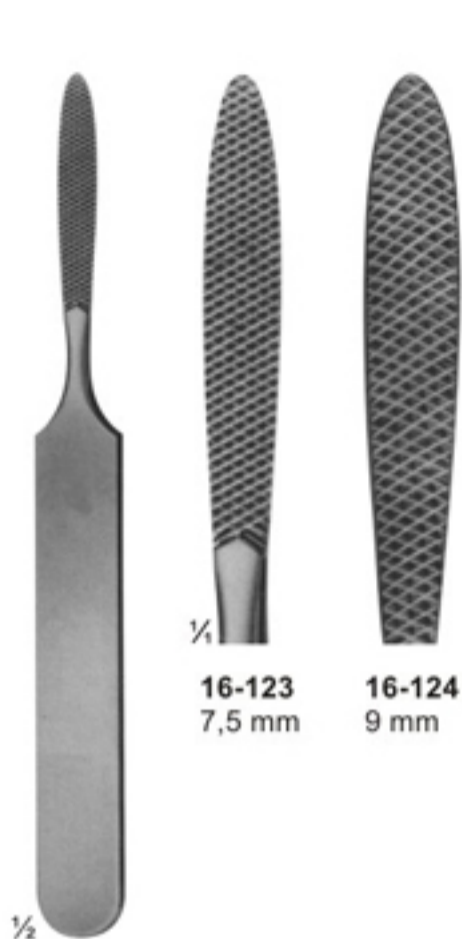

16-123
JOSEPH
fine, chequered

16-124
coarse, chequered
165 mm

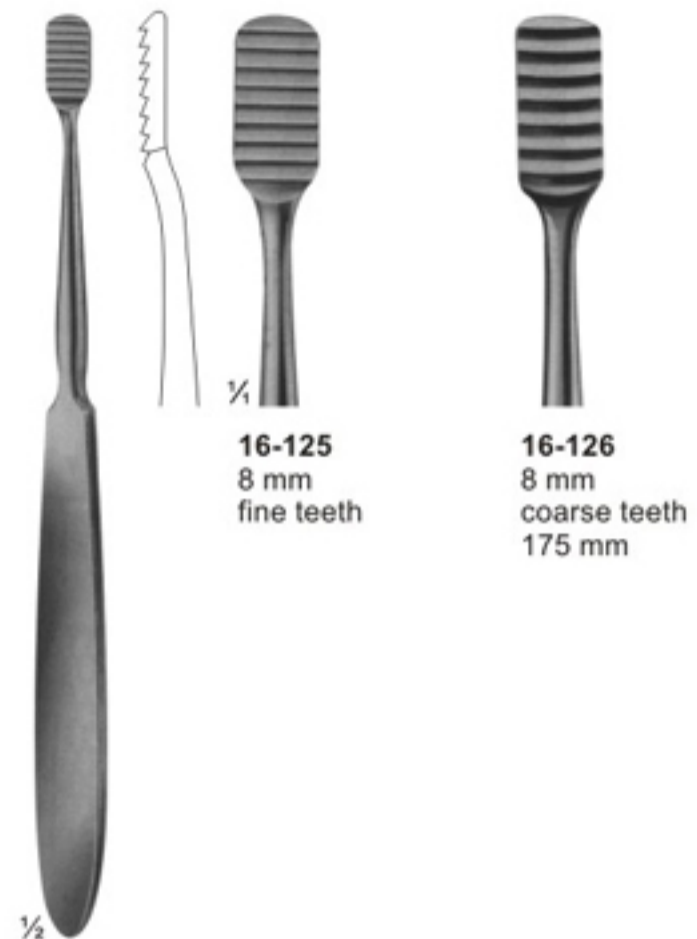

16-125 - 16-126
LEWIS



16-127
MALTZ
down stroke
180 mm

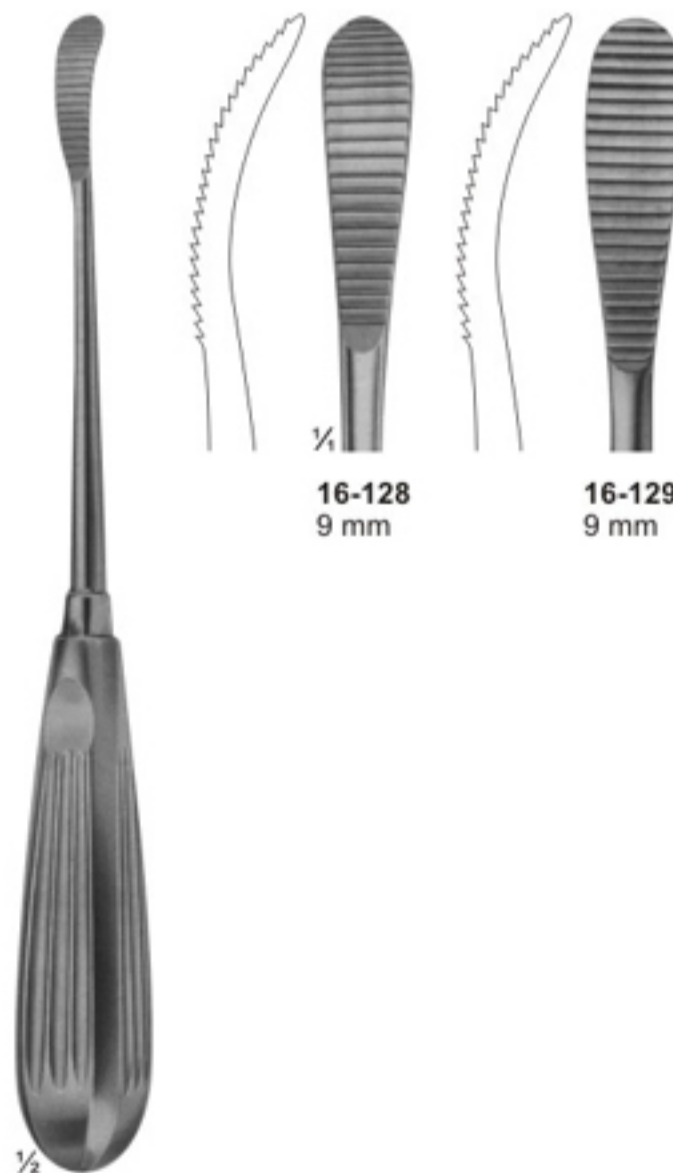

16-128 - 16-129
AUFRICHT
up stroke
16-129
down stroke
220 mm



16-130
GALLAHER
190 mm

Bone Currettes



16-131
JACOBSON
140 mm



16-132
MARTINI
140 mm



16-133
MARTINI
140 mm



16-134
WILLIGER
145 mm



16-135
JANSEN
160 mm



16-136
BARTH
180 mm



16-137
VOLKMANN
130 mm

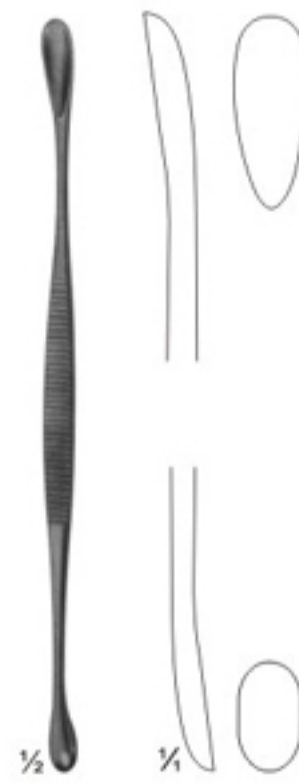

16-138
VOLKMANN
145 mm

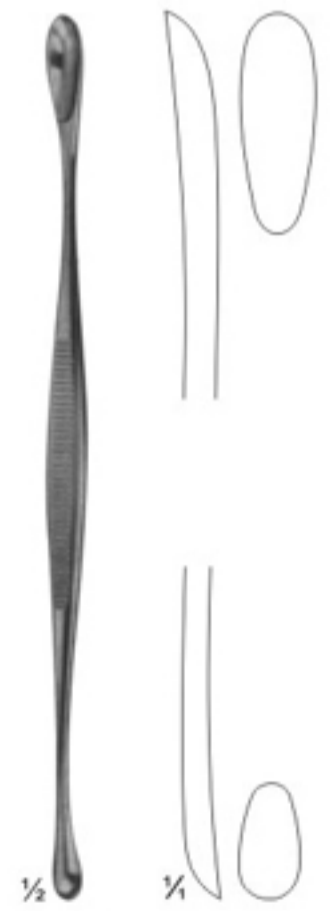

16-139
VOLKMANN
170 mm

Mallets Weights refer to the heads of the mallets
Hammer Die Gewichtsangaben beziehen sich auf den Kopf des jeweiligen Hammers



∅ 20 mm

½

17-101
MEAD
185 g
with interchangeable
plastic disks
190 mm
17-102
pair of spare disks



∅ 25 mm

½

17-103
140 g
with interchangeable
plastic disks
185 mm
17-104
pair of spare disks



∅ 30 mm

½

17-105
COTTLE
140 g
1 Side Flat
1 Side convex
185 mm



∅ 22 mm

½

17-106
165 g
lead filled head
190 mm

Osteotomes, Chisels and Gouges



17-107
MANNERFELT
 Gouge
 155 mm

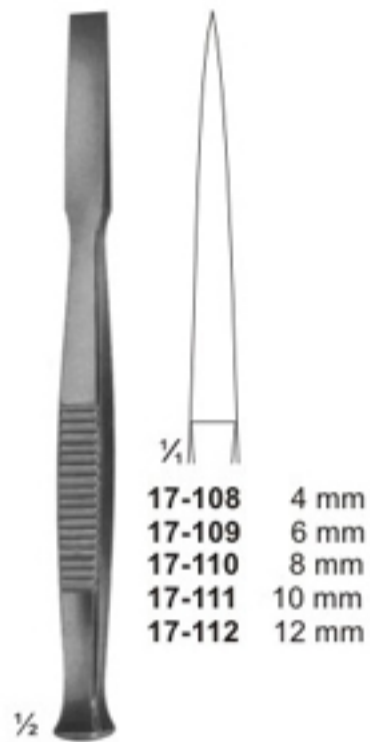

17-108 - 112
 Osteotomes
 140 mm

17-108 4 mm
17-109 6 mm
17-110 8 mm
17-111 10 mm
17-112 12 mm

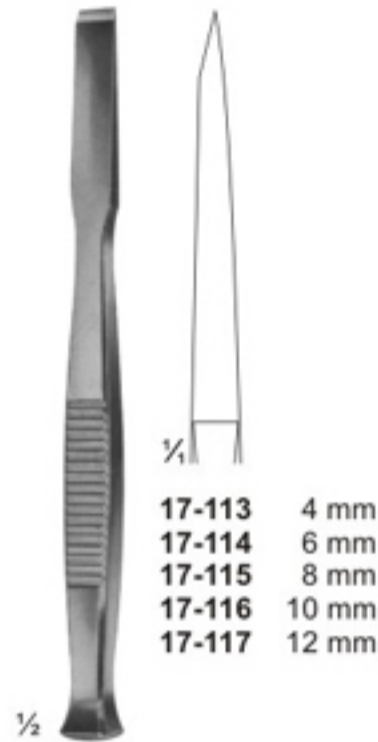

17-113 - 117
 Chisels
 140 mm

17-113 4 mm
17-114 6 mm
17-115 8 mm
17-116 10 mm
17-117 12 mm

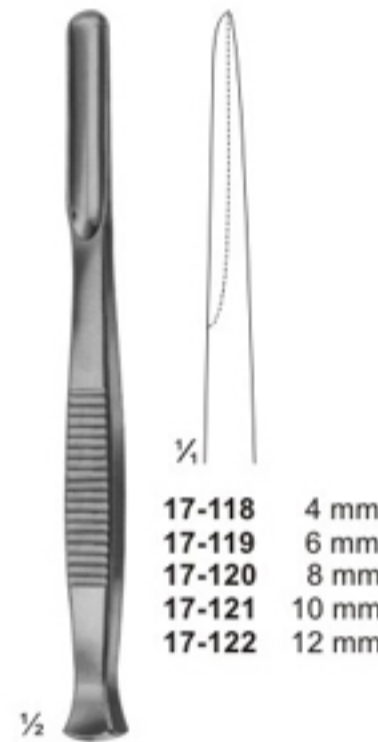

17-118 - 122
 Gouges
 140 mm

17-118 4 mm
17-119 6 mm
17-120 8 mm
17-121 10 mm
17-122 12 mm

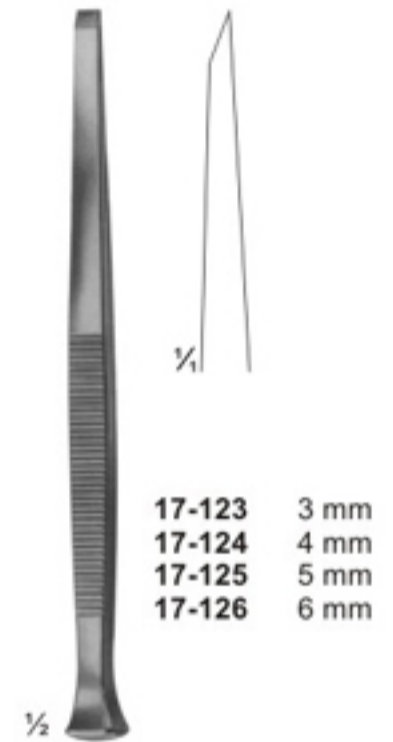

PARTSCH
17-123 - 126
 Chisels
 140 mm

17-123 3 mm
17-124 4 mm
17-125 5 mm
17-126 6 mm

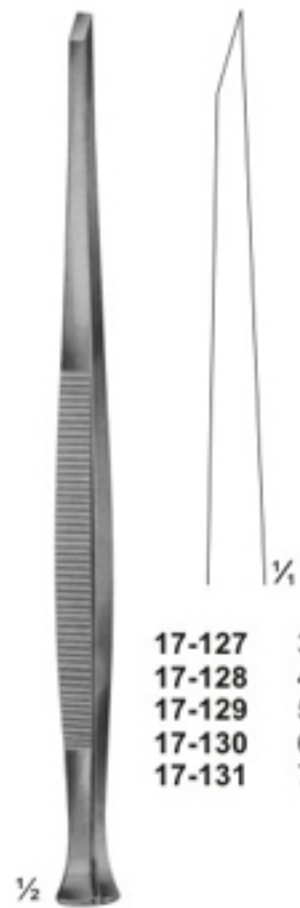

PARTSCH
17-127 - 131
 Chisels
 170 mm

17-127 3 mm
17-128 4 mm
17-129 5 mm
17-130 6 mm
17-131 7 mm

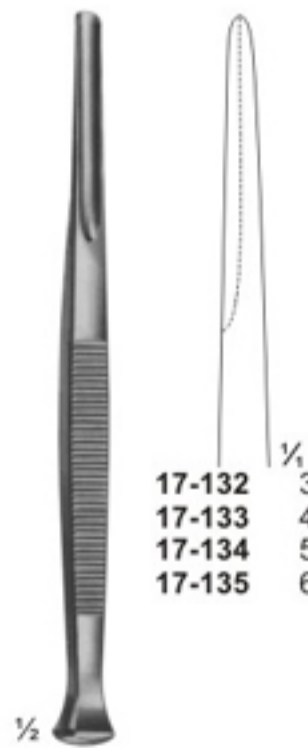

PARTSCH
17-132 - 135
 Gouges
 140 mm

17-132 3 mm
17-133 4 mm
17-134 5 mm
17-135 6 mm

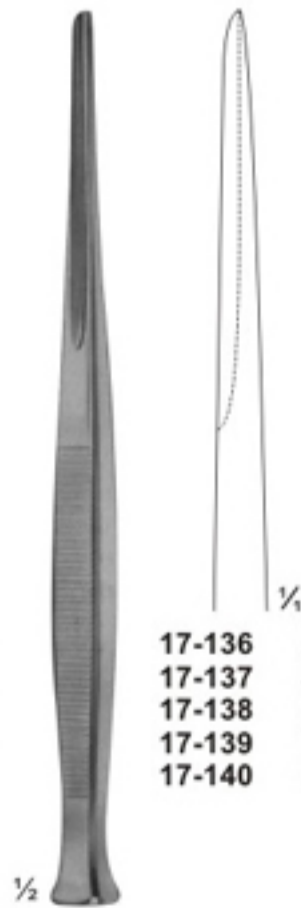

PARTSCH
17-136 - 140
 Gouges
 170 mm

17-136 3 mm
17-137 4 mm
17-138 5 mm
17-139 6 mm
17-140 7 mm



LUCAS
17-141 - 142
 Chisels
 160 mm

17-141 4 mm
17-142 6 mm

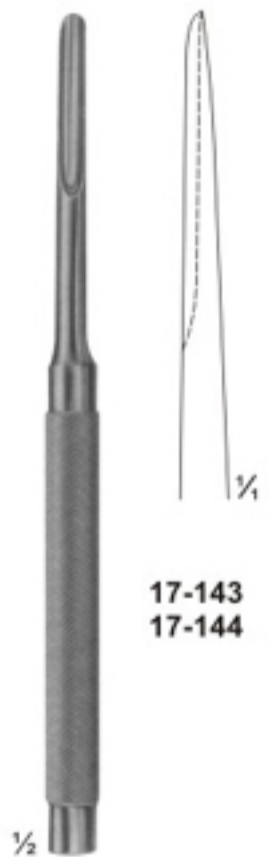

LUCAS
17-143 - 144
 Gouges
 160 mm

17-143 3 mm
17-144 5 mm

Reposition Forceps, Bone Holding Forceps



17-145
Patella forceps
185 mm



17-146
Forceps with
ratchet fixation
140 mm



17-147
Forceps with
thread fixation
170 mm



17-148
Forceps with
thread fixation
235 mm

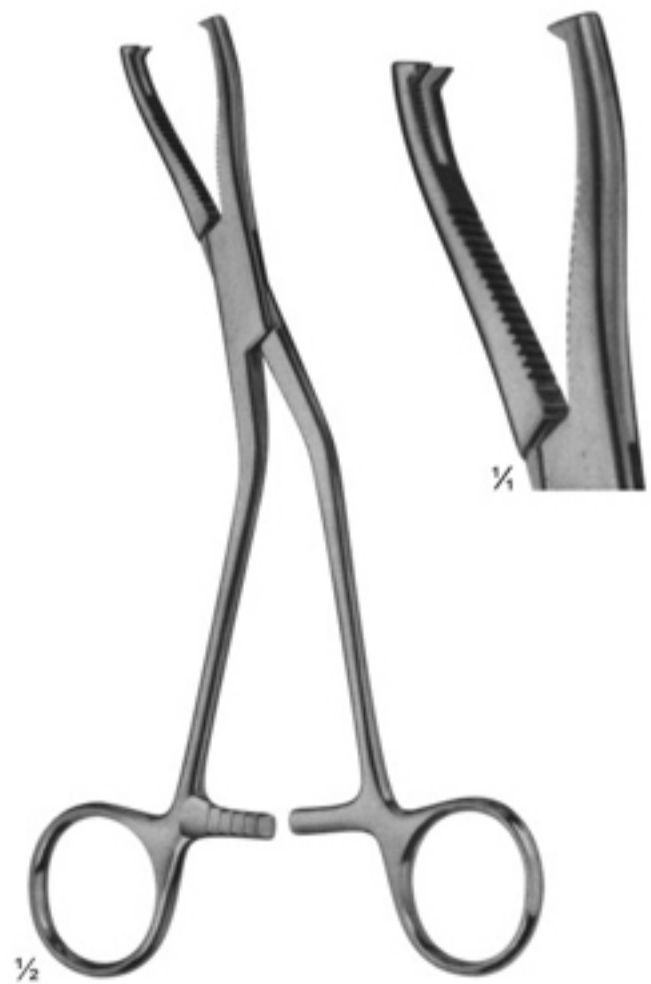

17-149
DINGMANN
185 mm

Bone Holding Forceps & Bone Clamps



Bone Rongeurs



17-158
LUER
150 mm



17-159
LUER
155 mm



17-160
BLUMENTHAL
155 mm



17-161
BLUMENTHAL
150 mm



17-162 - 163
JANSEN
175 mm

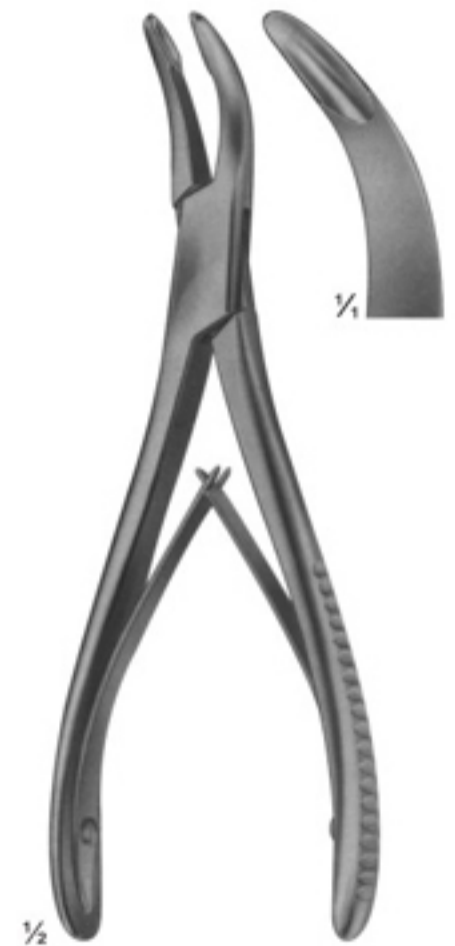

17-164
BANE-HARTMANN
175 mm

Bone Rongeurs



17-165
STILLE
235 mm



17-166
LEKSELL-STILLE
240mm



17-167
STILLE-RUSKIN
240mm

Bone Cutting Forceps

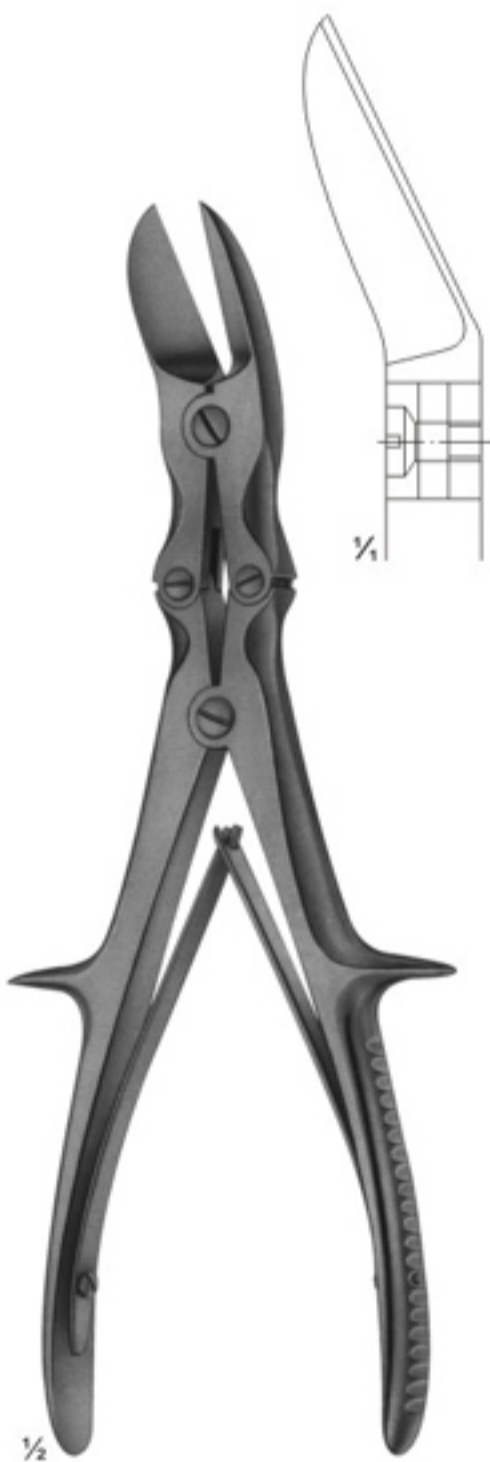

17-168
LISTON
curved on flat
240 mm

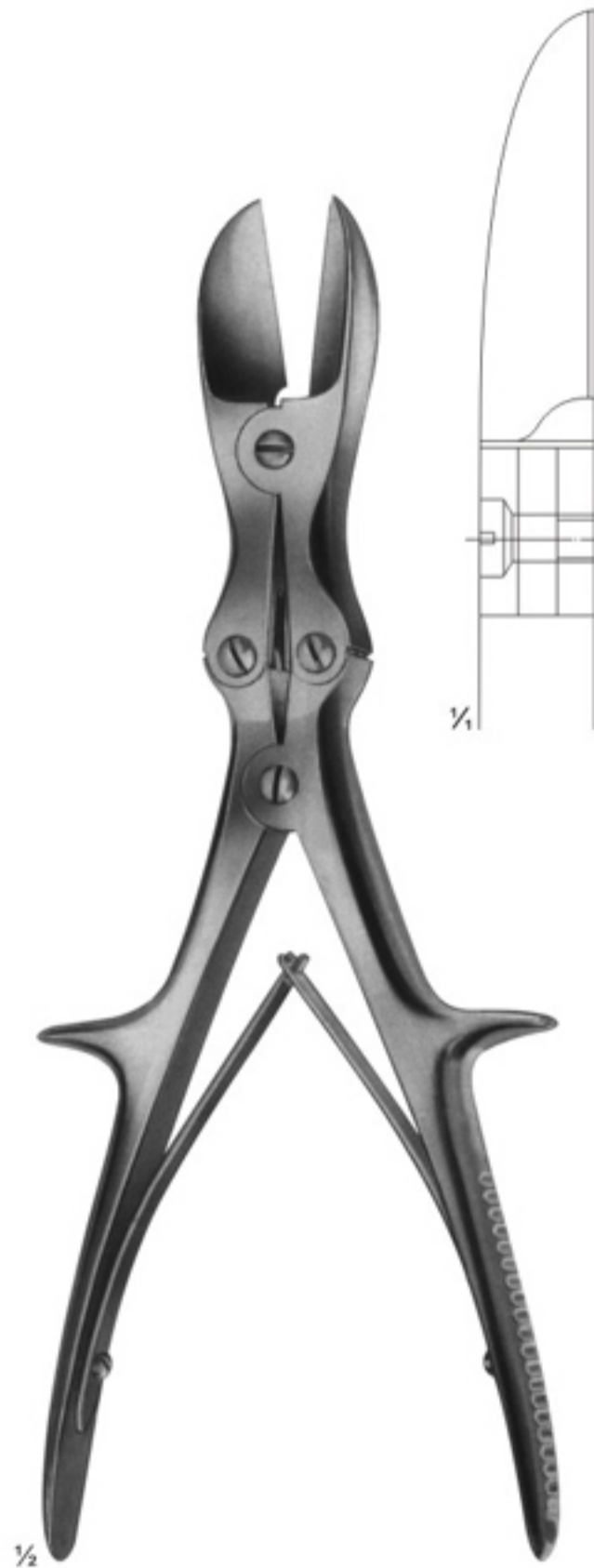

17-169
LISTON
straight
280 mm

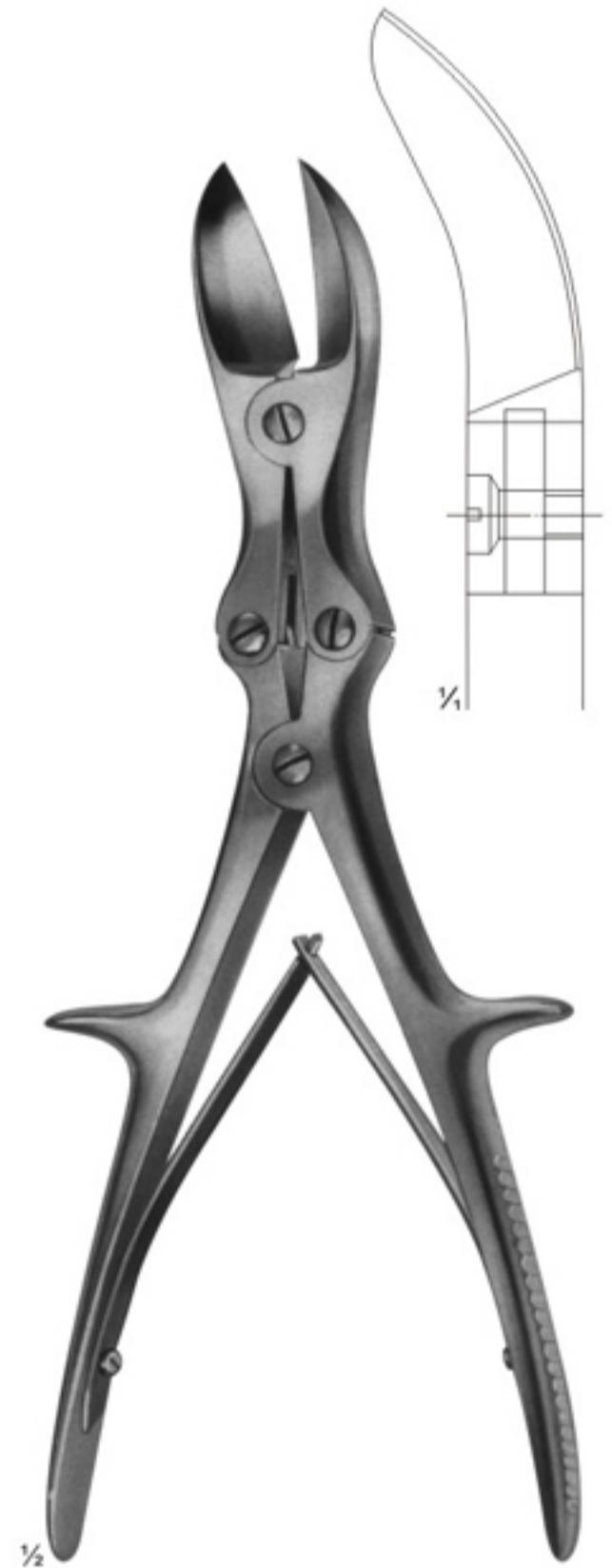

17-170
LISTON
curved on flat
280 mm

Wire Extension

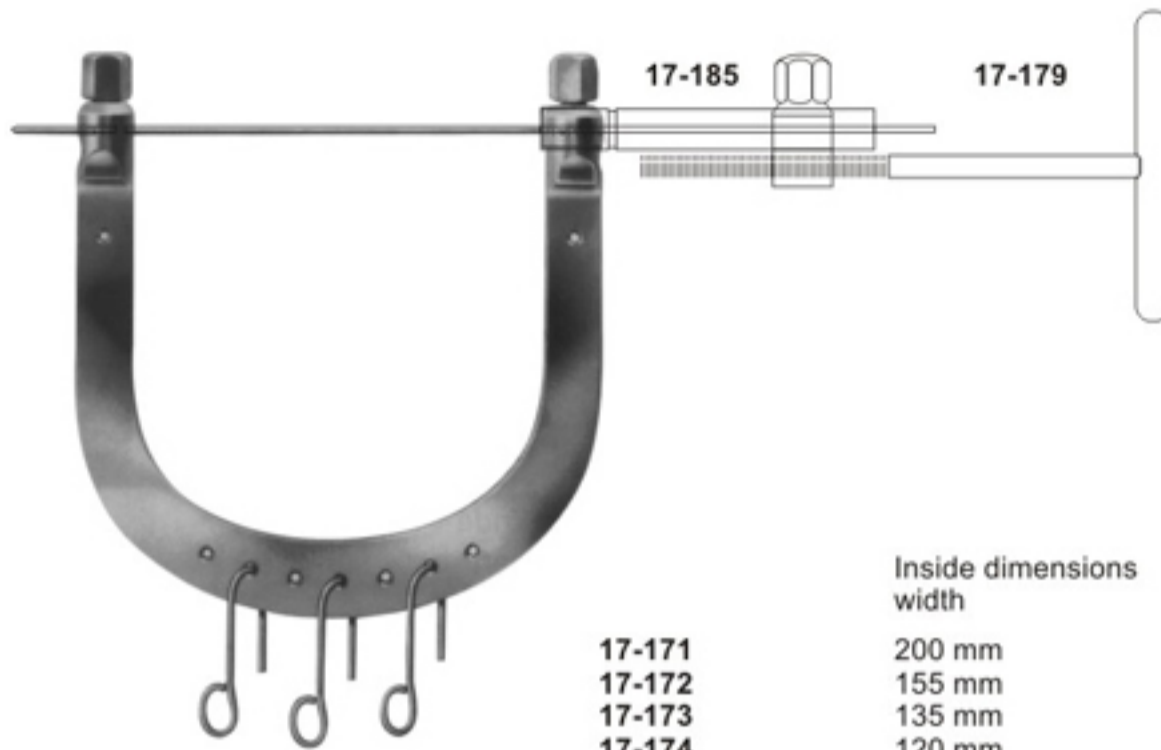

17-171 - 17-177
KIRSCHNER
 Wire traction bows,
 to be used with
KIRSCHNER-wires
 up to 2.5 mm diam.,
 With 3 hooks,
 stainless steel

	Inside dimensions width	depth	
17-171	200 mm	155 mm	for the hip
17-172	155 mm	155 mm	for the femur
17-173	135 mm	130 mm	for the knee
17-174	120 mm	120 mm	for the knee
17-175	105 mm	100 mm	for the knee
17-176	95 mm	110 mm	for the calcaneus
17-177	95 mm	70 mm	for the arm and elbow



17-178
 Wrench, double - ended,
 for wire traction bows



17-179
 Wire tightener, with
 clamping jaws



17-182 max. 105 mm
17-183 max. 160 mm
17-184 max. 200 mm

17-182 80-95 mm
17-183 90-120 mm
17-184 140-170 mm

diam upto
17-182 1,6 mm
17-183 2,0 mm
17-184 2,5 mm

17-182 - 17-184
KIRSCHNER
 Wire traction bows, modified,
 adjustable in width, holds wire
 securely, with 1 hook



17-180
 Traction hook only,
 large size



17-181
 Traction hook only,
 small size



17-185
 Fixation clamp, to secure clamping
 jaws of **17-179** stainless steel

Cerclage Instruments

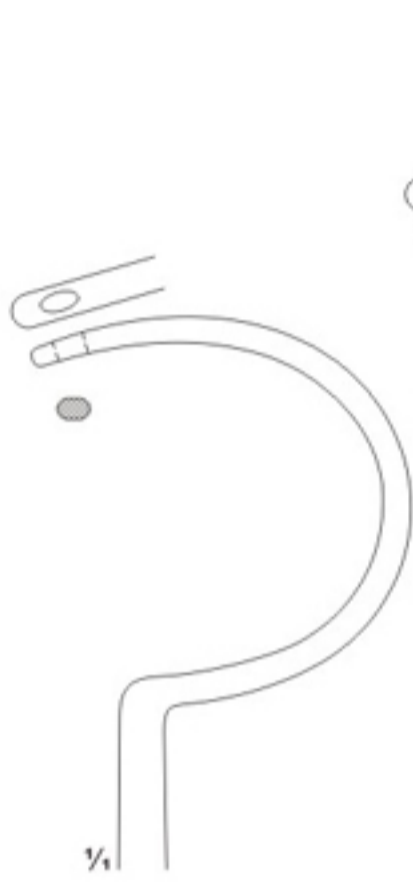

17-186
275 mm

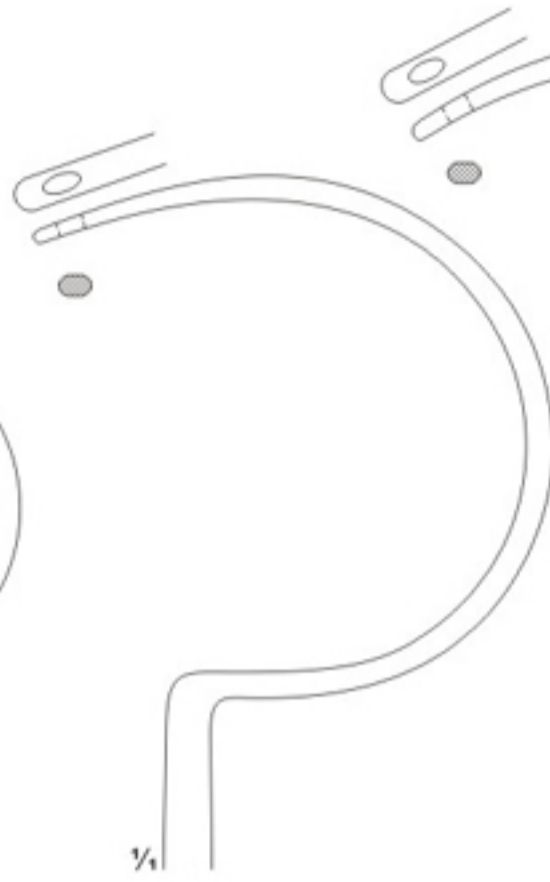

17-187
285 mm

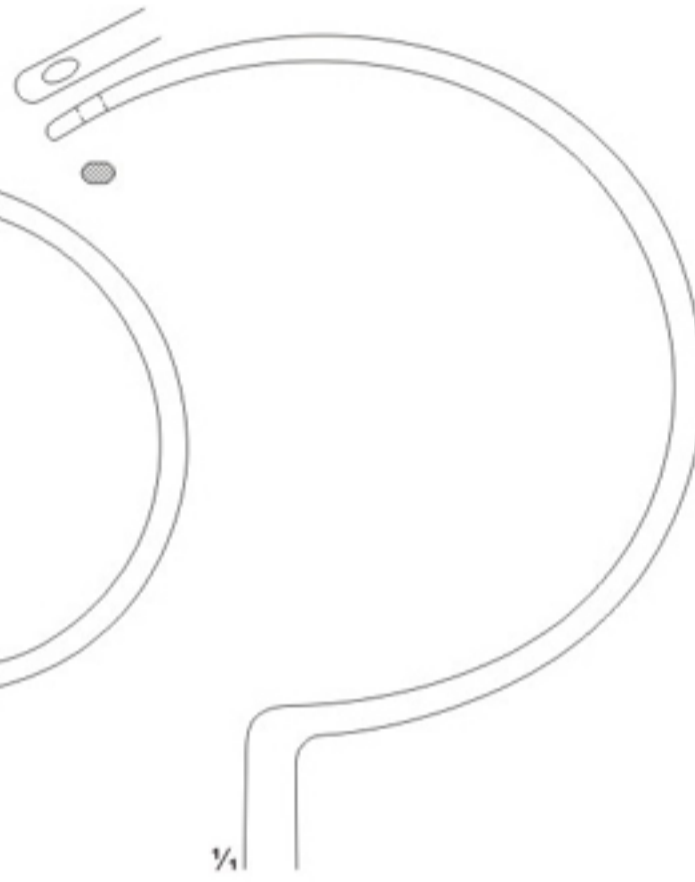

17-188
305 mm



17-186 - 17-188
DEMEL
Wire guides

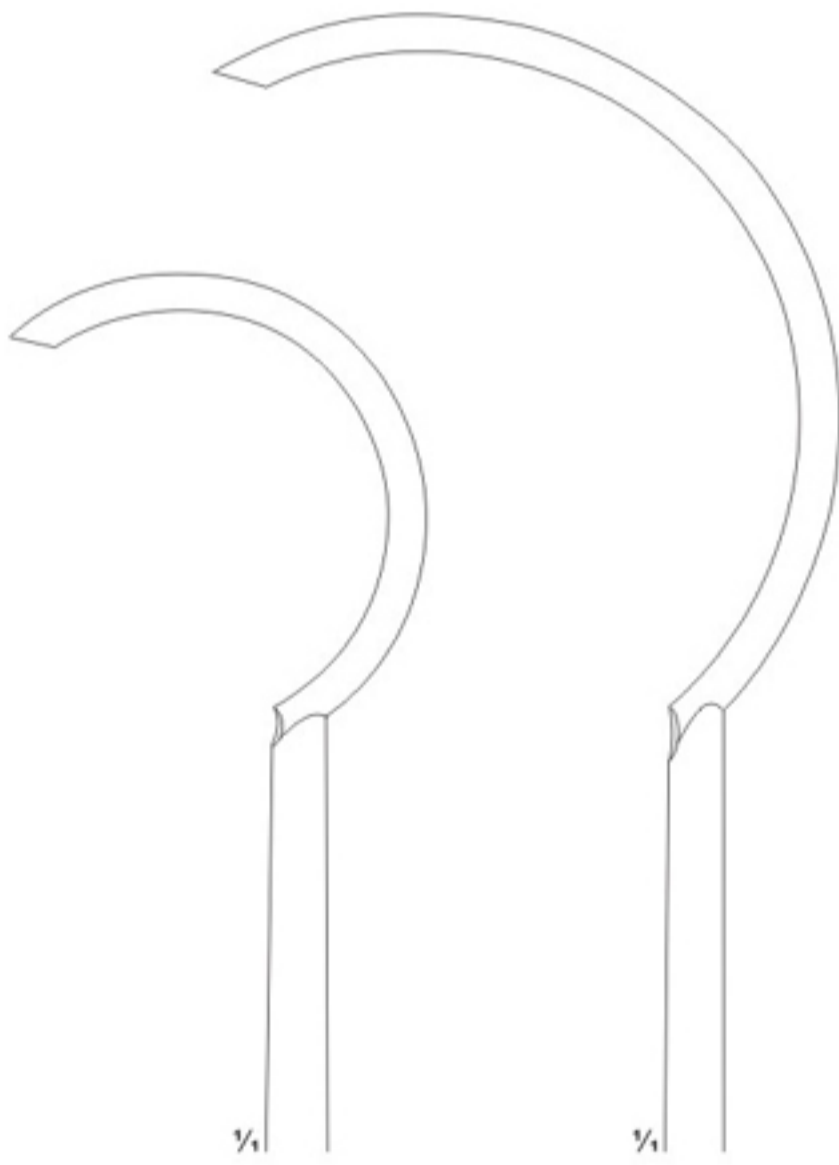

17-189
240 mm



17-190
270 mm

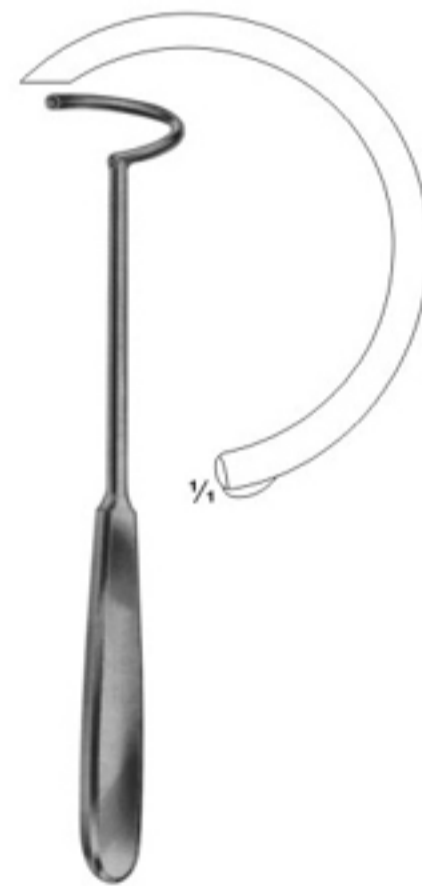

17-191
225 mm

Wire Holding forceps, Wire Tightening Pliers, Flat-nosed Pliers DUROGRIP with Hard Metal Inserts



17-192
 DUROGRIP
 Holding forceps for cerclage wire, with lateral jaws to avoid wire slipping off
 170 mm



17-193
 DUROGRIP
 Wire, tightening pliers, Ligature pliers
 150 mm



17-194
 DUROGRIP
 Wire, tightening pliers, Ligature pliers
 150 mm



17-195
 with serrated jaws
 140 mm



17-196
 one jaw smooth, one jaw serrated
 140 mm



17-197
 with serrated jaws
17-198
 with longitudinal and transversal grooves
 170 mm



17-199
 190 mm

Wire Holding forceps, Flat-nosed Pliers, Pliers for bending and cutting wires

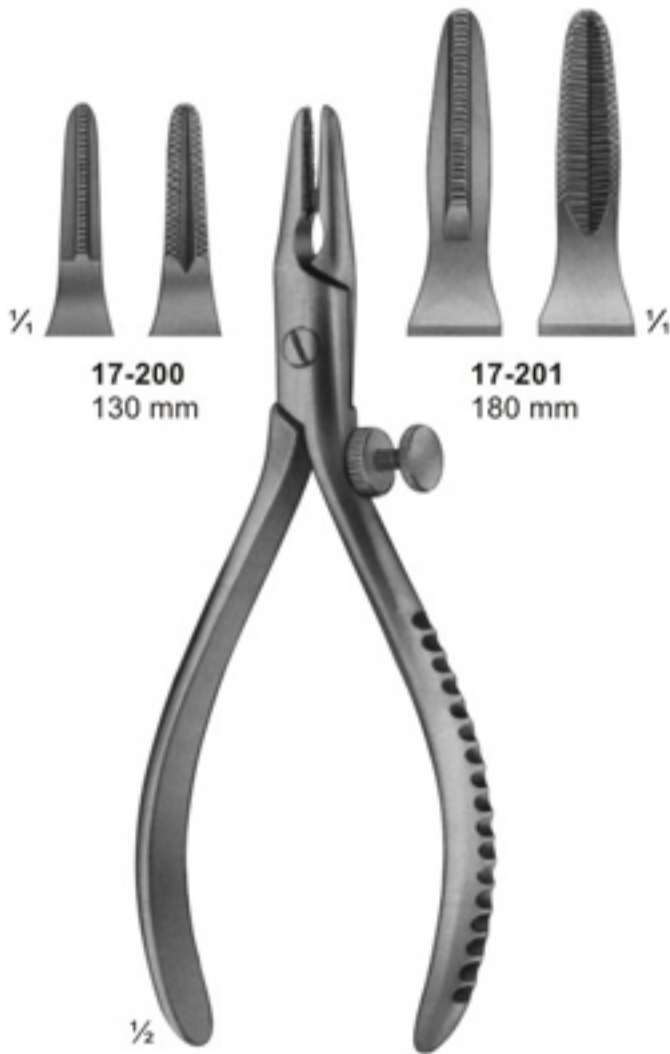

17-200
130 mm

17-201
180 mm

17-200 - 17-201
Extraction pliers
for boring wires



17-202
Flat-nosed pliers,
parallel
185 mm

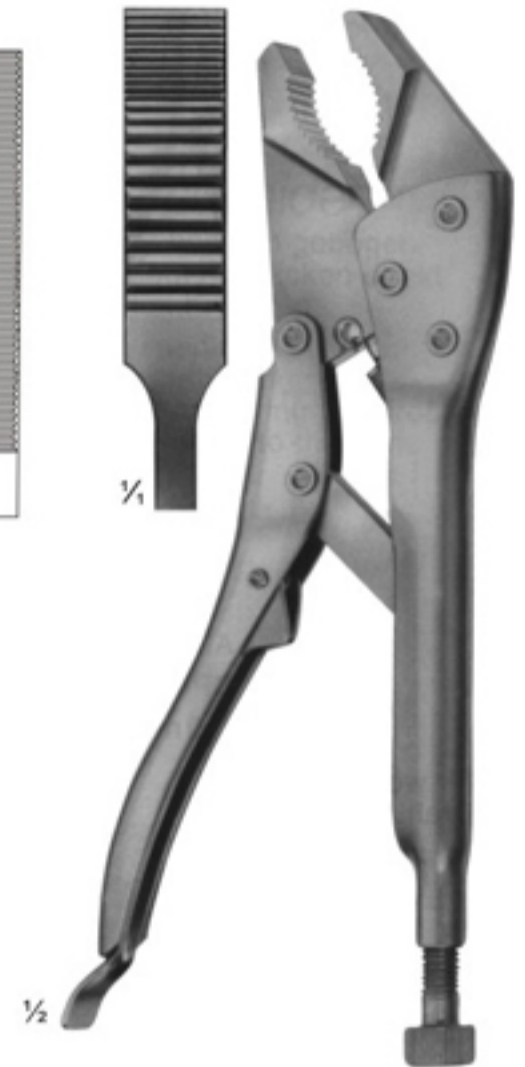

17-203
Vise grip
200 mm

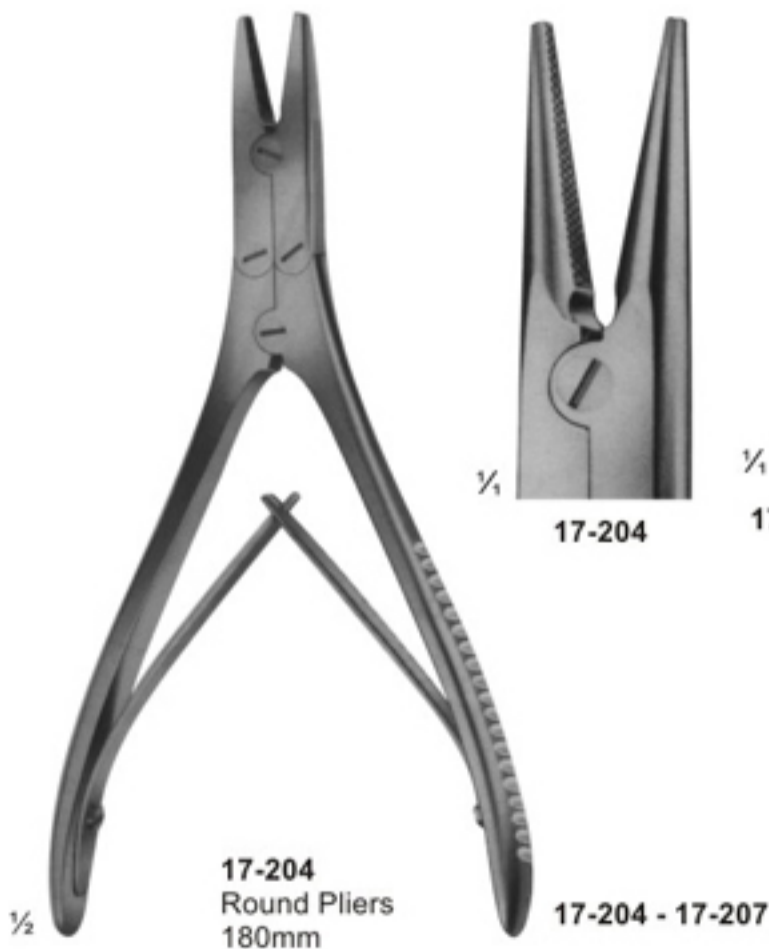

17-204
Round Pliers
180mm

17-204 - 17-207

17-205 145 mm
17-206 180 mm
17-207 180 mm
Extraction pliers for wires



17-208
Bending pliers
for wires up to
1.8 mm diam.

Wire Cutters and wire Cutting Scissors

DUROTIP with Carbide Cutting Edges



17-209
 ANGLE
 130 mm

for soft wire
 up to diam.
 for hard wire
 up to diam.

0,5 mm
 0,3 mm

17-210
 DUROTIP
 ANGLE
 130 mm

0,6 mm
 0,4 mm

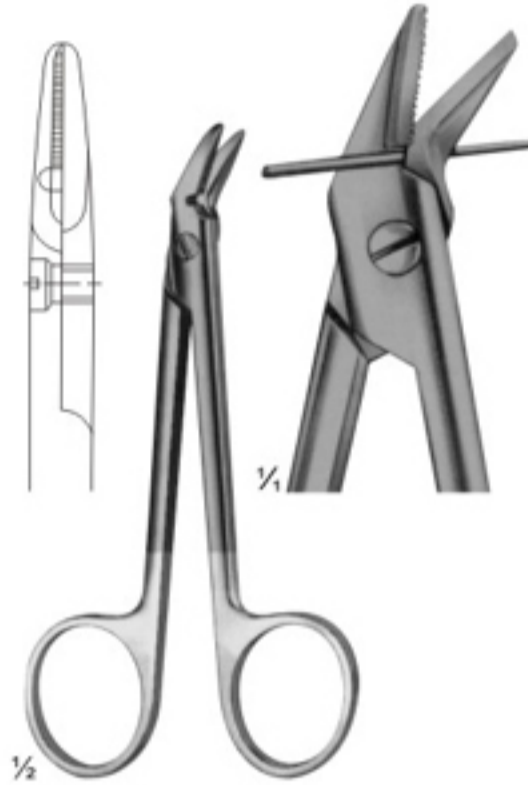

17-211
 120 mm

for soft wire
 up to diam.
 for hard wire
 up to diam.

1,2 mm
 0,8 mm

17-212
 DUROTIP
 120 mm

1,2 mm
 0,8 mm

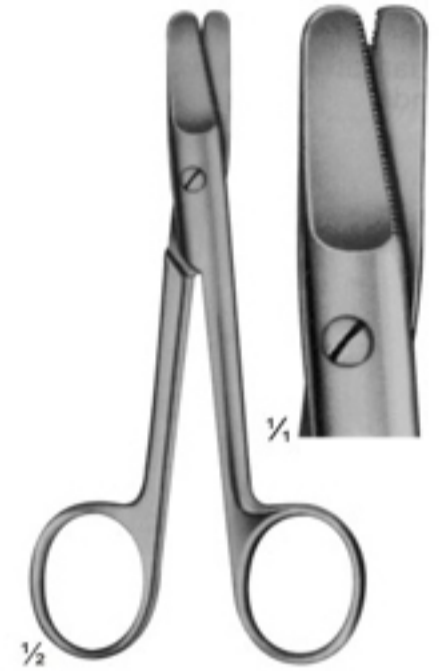

17-213
 HARVEY
 125 mm

0,4 mm
 0,3 mm



17-214
 150 mm

for soft wire
 up to diam
 for hard wire
 up to diam

1,5 mm
 1,0 mm



17-215
 160 mm

1,5 mm
 1,2 mm



17-216
 140 mm
 DUROTIP
 1,5 mm

1,0 mm

Wire Cutting Pliers, Lateral Cutting Action



17-217
180 mm

for soft wire
up to diam. 2,0 mm
For hard wire 1,5 mm
up to diam
specially hardened
cutting edges, front
and lateral cutting
action



17-218
REILL
175 mm

for soft wire
up to diam. 2,0 mm
For hard wire 1,6 mm
up to diam
specially hardened
cutting edges, for
cutting off wires close
to the bone



DUROTIP

17-219
235 mm

for soft wire
up to diam. 3,0 mm
For hard wire 2,2 mm
up to diam

Wire Cutting Pliers, Lateral and Front Cutting Action



17-220
240 mm

for soft wire up to diam. 2,0 mm
For hard wire up to diam. 1,6 mm



17-221
145 mm

for soft wire up to diam. 1,5 mm
For hard wire up to diam. 1,0 mm



17-222
145 mm

for soft wire up to diam. 2,0 mm
For hard wire up to diam. 1,5 mm



17-223
220 mm

for soft wire up to diam. 3,5 mm
For hard wire up to diam. 2,5 mm

Wire Cutting Pliers



17-224
320 mm

for soft wire
up to diam. 3,0 mm
For hard wire
up to diam 3,0 mm



Cutter for cutting off
KIRSCHNER wires,
Tibia head screws,
bolts, pins, up to 3 mm diam.



DUROTIP

17-225
Cutter for cutting off
KIRSCHNER wires,
Tibia head screws,
bolts, pins, up to 6 mm diam.
470 mm

Finger Nail Instruments

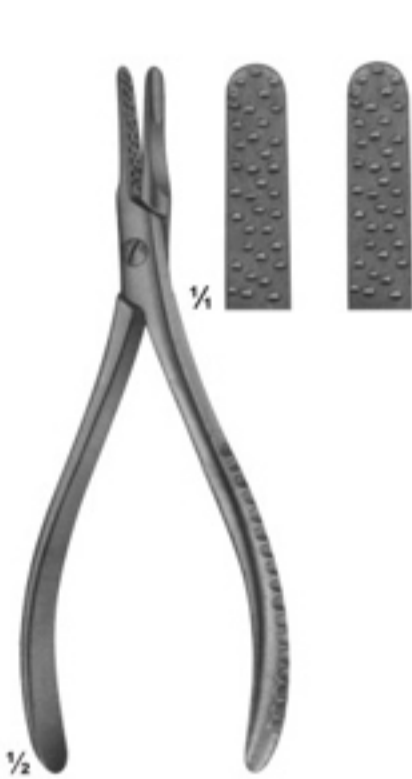

17-226
Nail extracting
forceps
135 mm



17-227
Nail extracting
forceps
145 mm

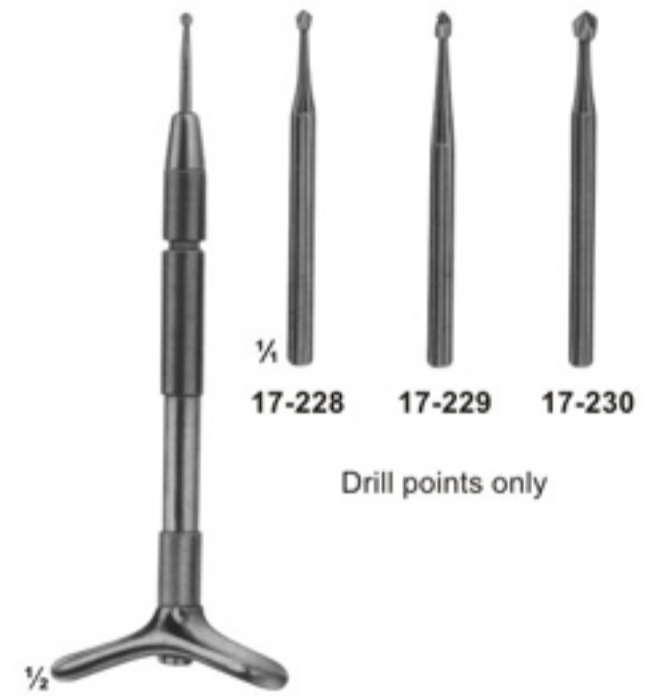

17-228
Finger nail drill
with 3 drill points

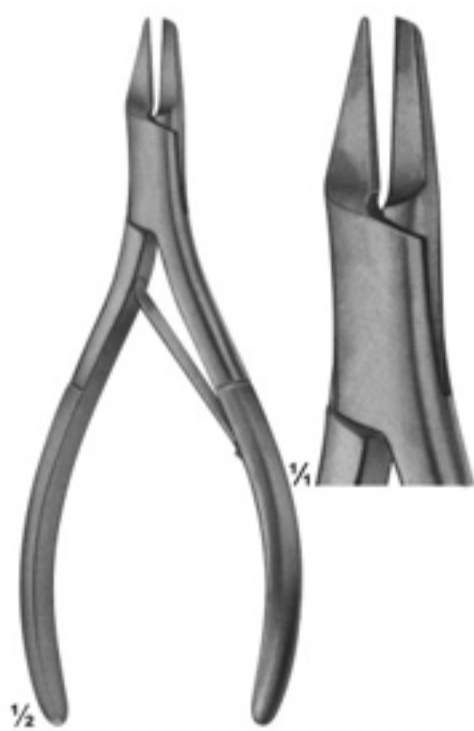

17-231
Nail splitting
forceps
135 mm



17-232
SYSTRUNK
Scissors, for splitting
finger nails
130 mm



17-233
Finger ring saw
150 mm

Plaster Shears



17-235
STILLE-AESCALAP
260 mm



17-236
STILLE-AESCALAP
360 mm

Plaster Spreader, Plaster Breakers



17-237
HENING
270 mm



17-238
MOD.USA
230 mm



17-239
290 mm



with removable jaws



17-240 - 17-241
WOLFF
17-240 180 mm
17-241 240 mm
plaster breakers

Vacuum Currettes for Aspiration Lipectomy, Suction Instruments

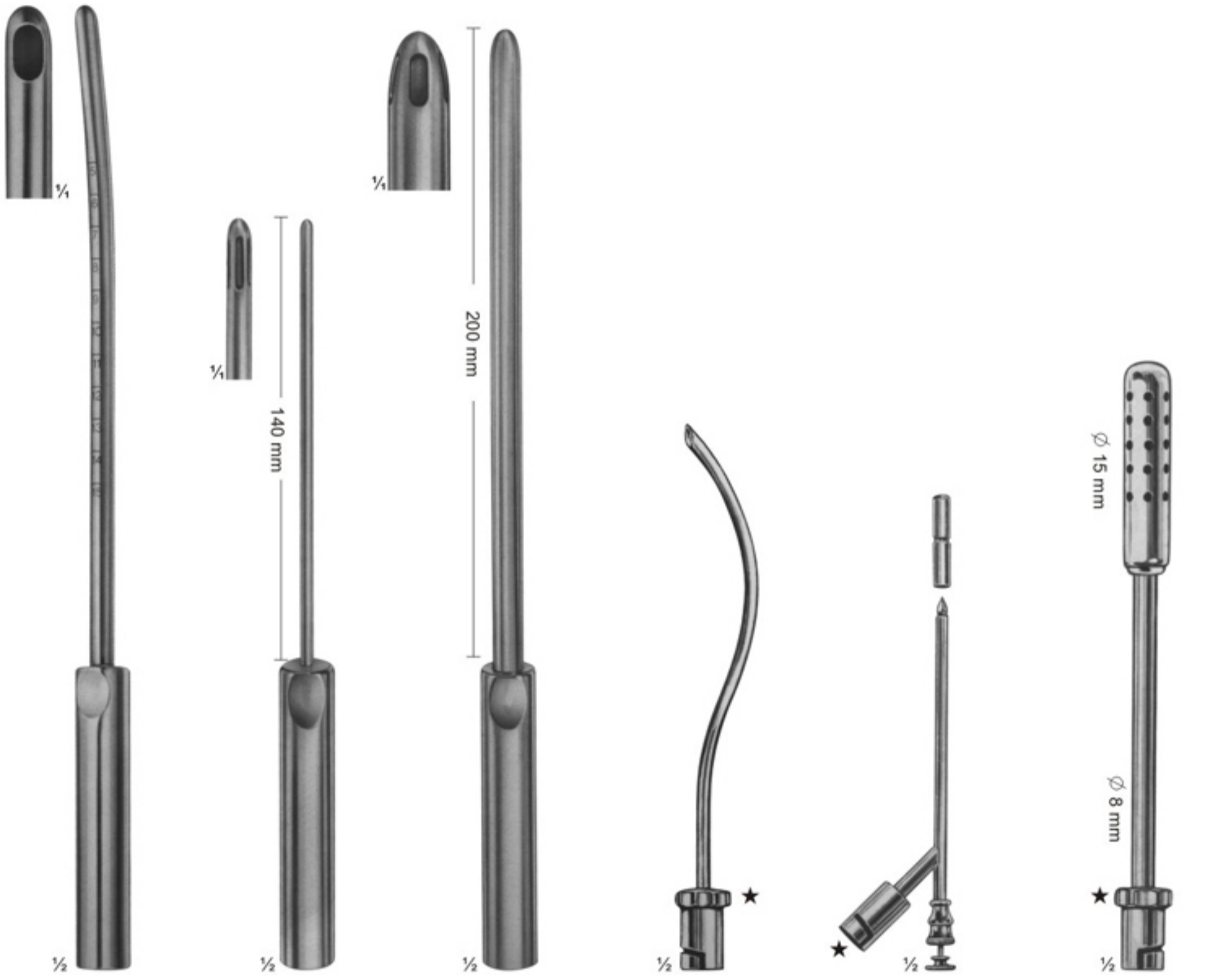

18-101 - 18-106
 BIEMER
 18-101 ∅ 4 mm
 18-102 ∅ 6 mm
 18-103 ∅ 8 mm
 18-104 ∅ 10 mm
 18-105 ∅ 12 mm
 18-106 ∅ 14 mm
 Currettes for aspiration lipectomy, graduated, slightly curved

18-107 - 18-108
 BIEMER
 18-107 ∅4 mm
 18-108 ∅6 mm
 Currettes for aspiration lipectomy, with three apertures, slightly curved malleable

18-109 - 18-111
 BIEMER
 18-109 ∅8 mm
 18-110 ∅10 mm
 18-111 ∅12 mm
 Currettes for aspiration lipectomy, with three apertures, slightly curved malleable

18-112
 For aspirating fluid from the excretory ducts of large glands and for keeping the operating area clear
 170 mm

18-113
 Trocar
 For puncturing
 150 mm

18-114
 For clearing large quantities of fluid
 190 mm

Suction Instruments

18-115 150mm
Suction handle, with vacuum regulator and finger cut-off, brass, mirror-finish chromium-plated



olive
Ø 9 mm

18-116 170mm
Suction handle, with hand regulation valve and quick-shutter, brass, mirror-finish chromium-plated



Both suction handles have bayonet fitting Olive and can be used for the suction cannulae. Ø 9 mm



18-117
Trocar
For puncturing
170 mm



18-118
Hollow needle,
sharp
150 mm



18-119
double curved
For general
surgery
230 mm



18-120
For tonsillectomy,
oral and laryngeal
operations
190 mm



18-121
For tonsillectomy,
oral and laryngeal
operations
220 mm

★ With bayonet fitting to be used with suction handles (18-115 - 18-116)

Suction Instruments

18-122
WULLSTEIN
 Suction tube, conical, silver, olive
 with LUER hub
 160 mm



18-123 1,5 mm
18-124 2,0 mm
WULLSTEIN
 Suction tube, cylindrical, silver, with
 stylet olive with LUER hub
 160 mm



Usable length

YASARGIL usable length diam.		YASARGIL usable length diam.	
18-125	130 mm 1,5 mm	18-133	130 mm 2,5 mm
18-126	150 mm 1,5 mm	18-134	150 mm 2,5 mm
18-127	180 mm 1,5 mm	18-135	180 mm 2,5 mm
18-128	220 mm 1,5 mm	18-136	220 mm 2,5 mm
18-129	130 mm 2,0 mm	18-137	130 mm 3,5 mm
18-130	150 mm 2,0 mm	18-138	150 mm 3,5 mm
18-131	180 mm 2,0 mm	18-139	180 mm 3,5 mm
18-132	220 mm 2,0 mm	18-140	220 mm 3,5 mm
		18-141	180 mm 4,5 mm

18-142 - 18-144
LANDOLT
 150 MM
 diam $\varnothing 3 \text{ mm}$

18-142 8 mm / curved
18-143 11mm / curved
18-144 15mm / curved

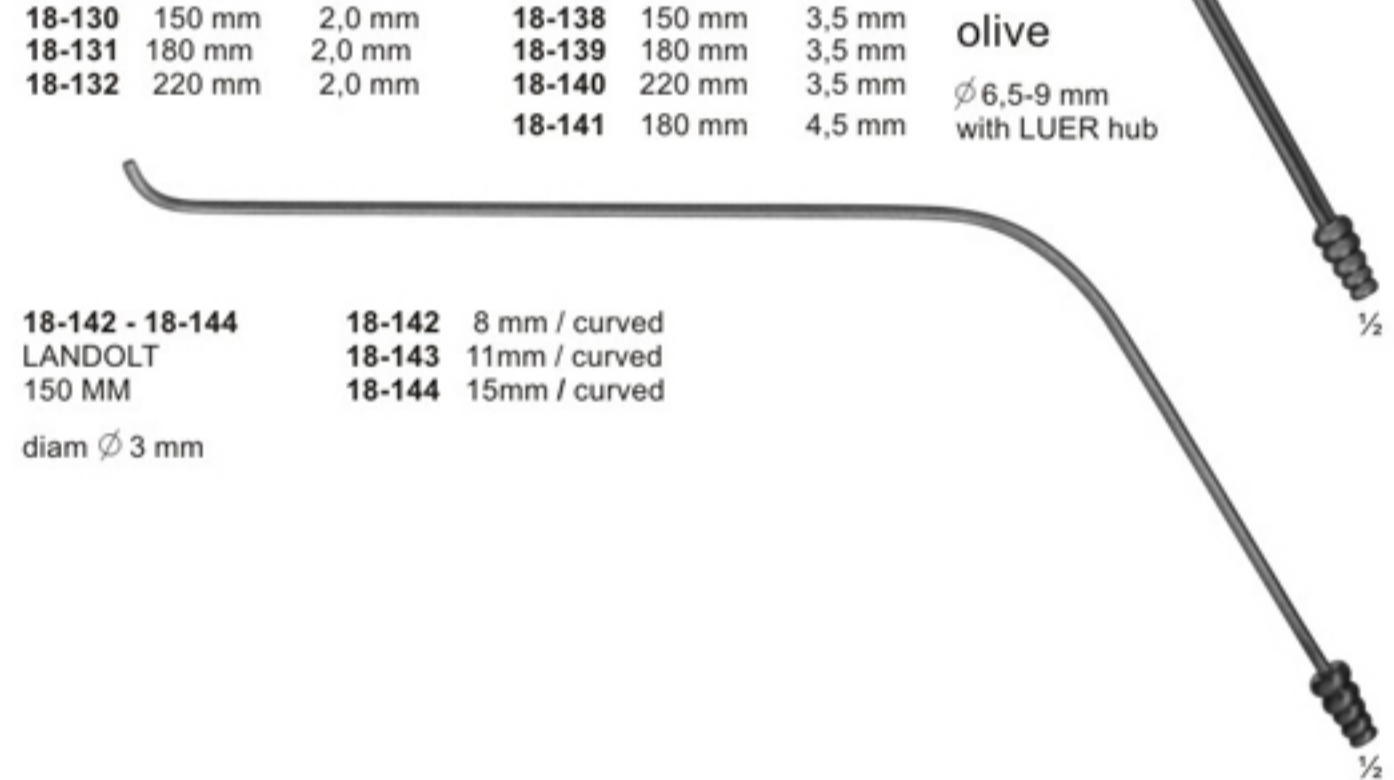

18-147 2,0 mm diam
18-148 2,5 mm diam
18-149 3,0 mm diam
 with finger cut-off,
 thumb piece 90° to
 curve, with LUER hub
 250 mm



Combined Suction and Irrigation Cannulae, Coagulation Suction Cannulae

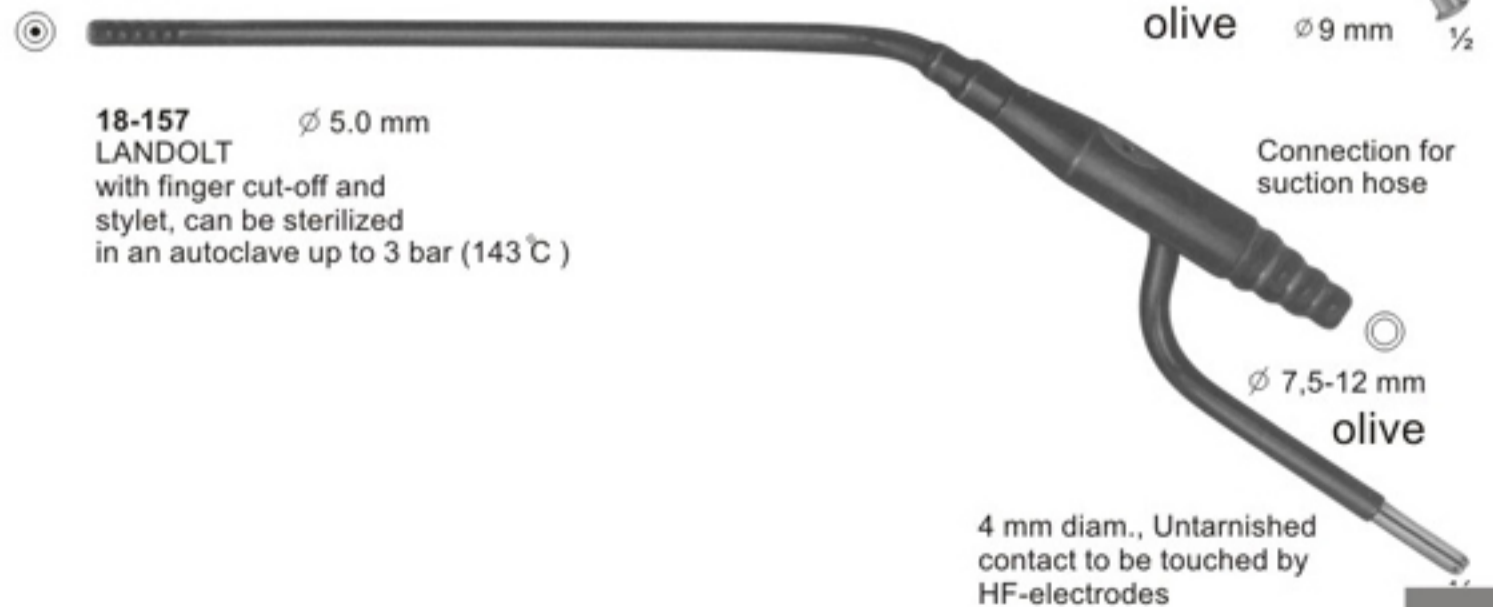
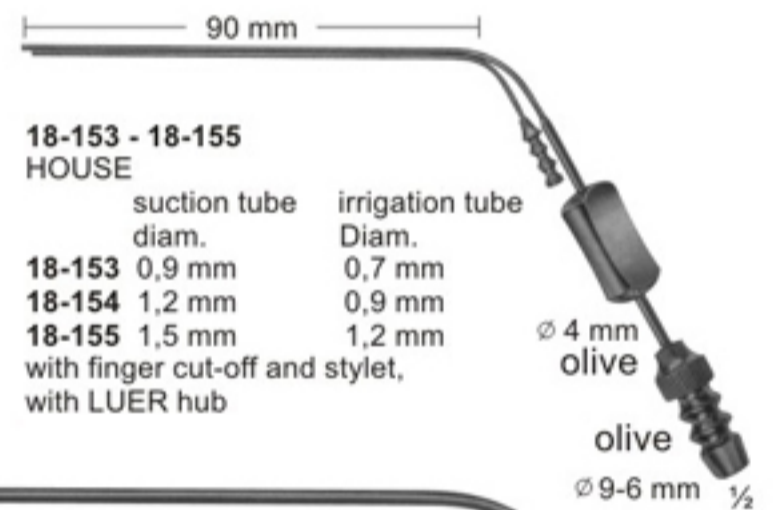
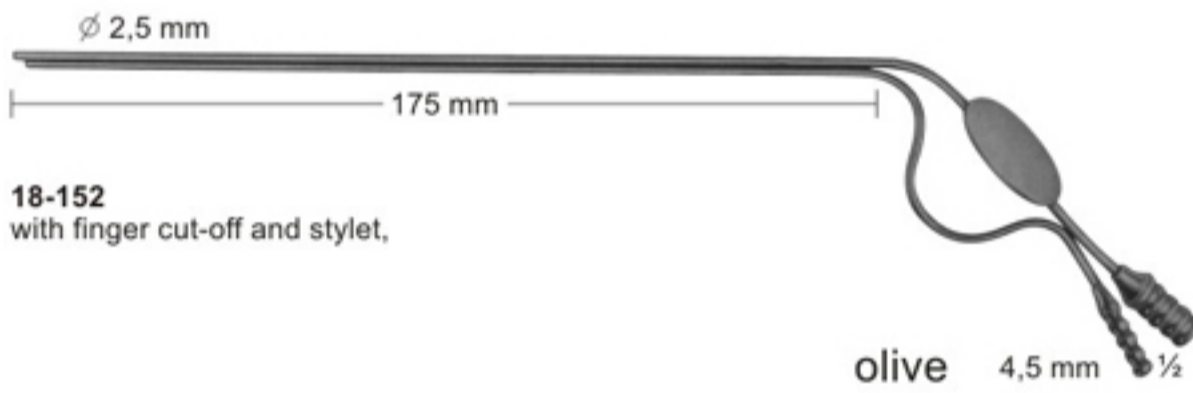
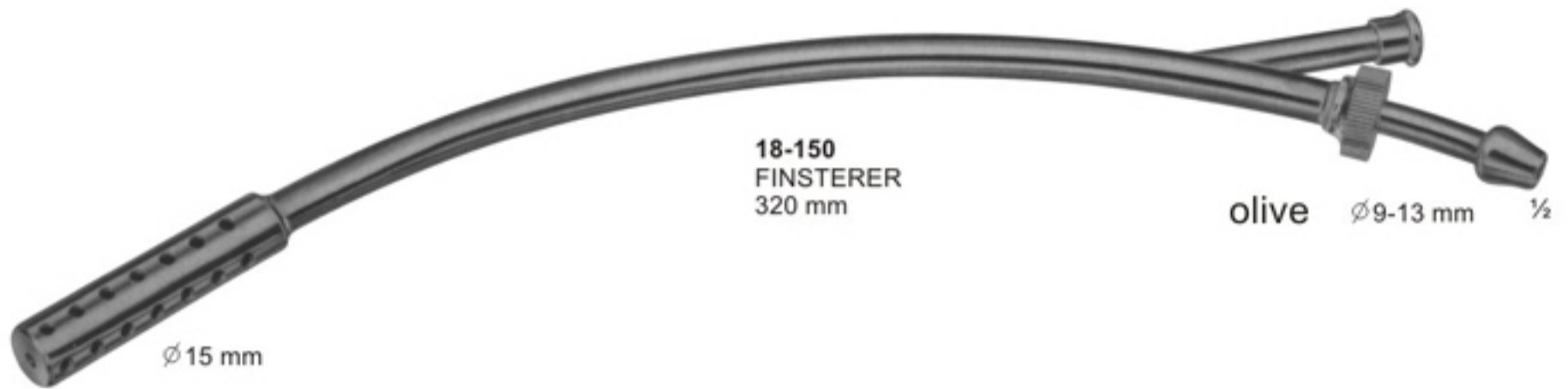

Suction Instruments

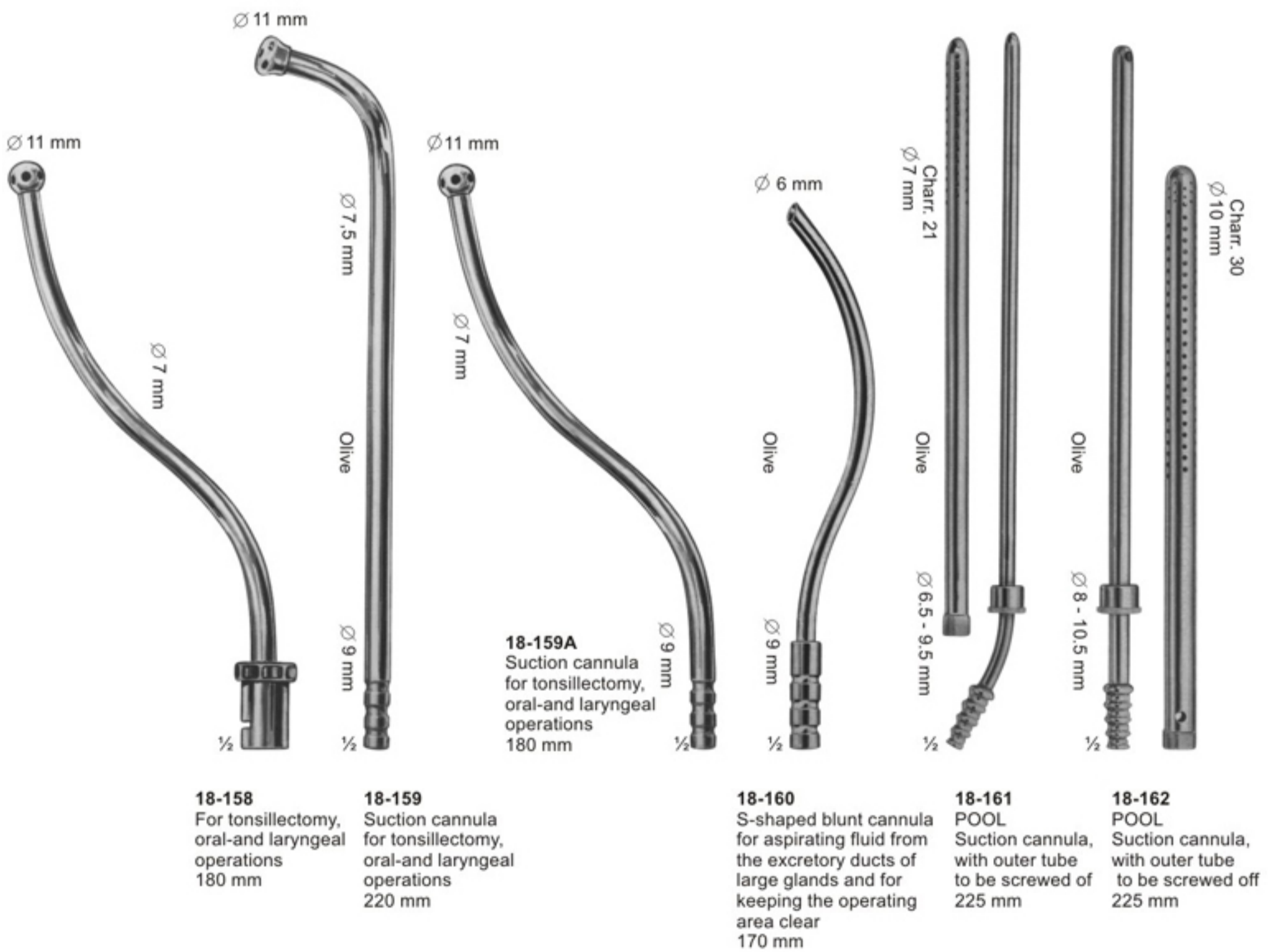

Suction Instruments

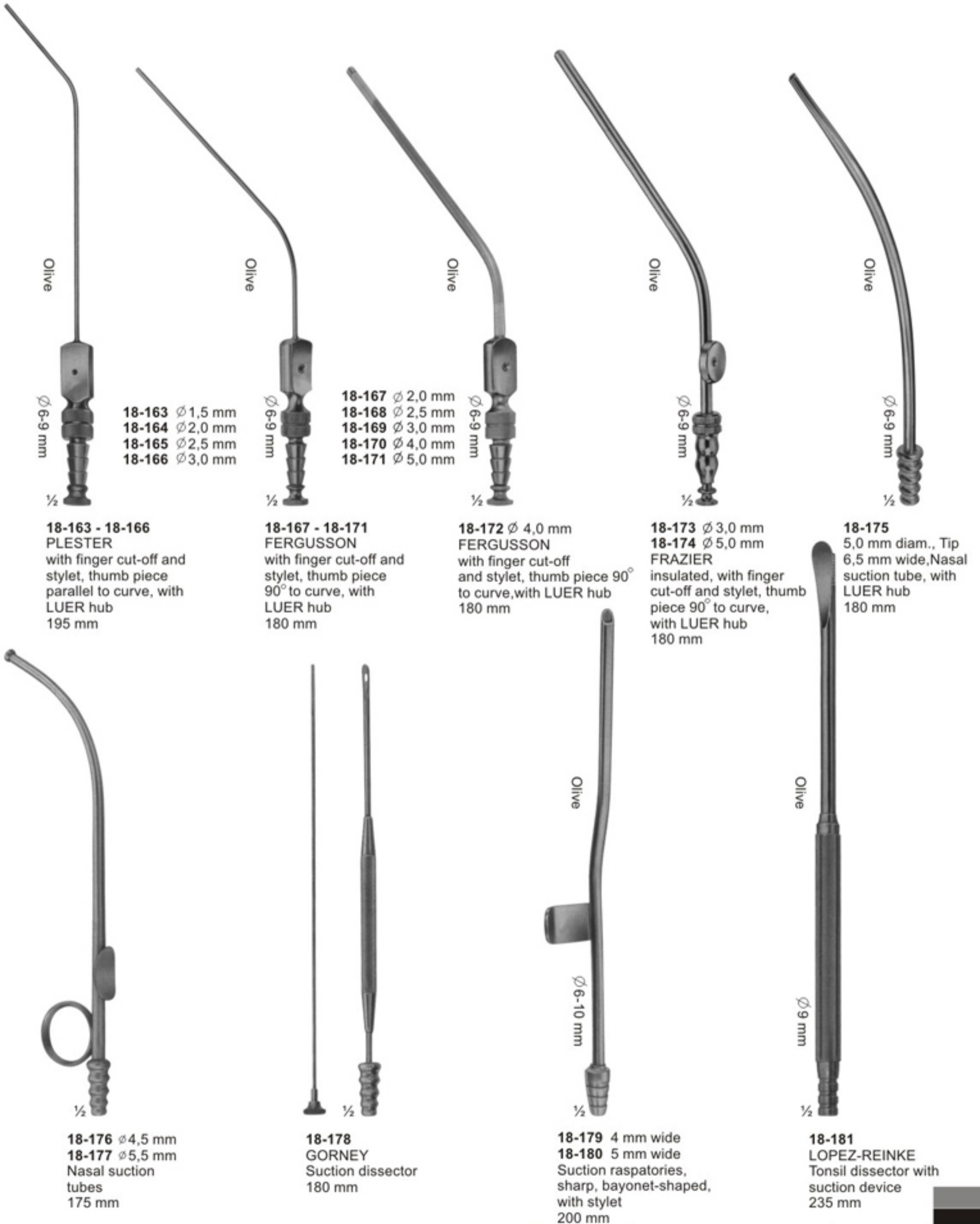

Dissection Instruments

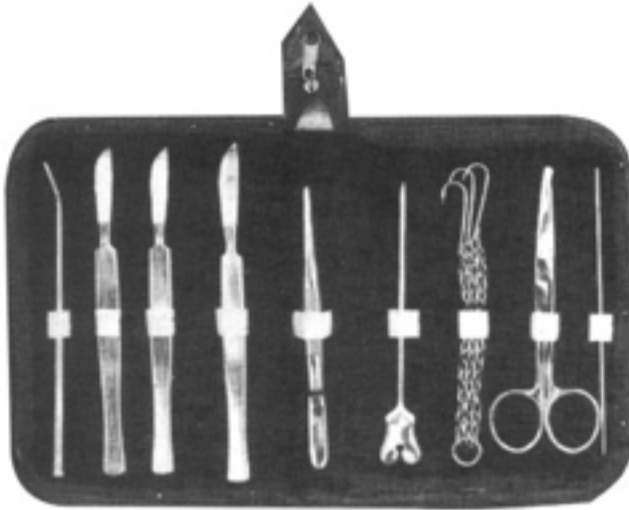

18-182

- 1- Blow pipe .
- 2- 3 PCS .scalpel.
- 3- Dissecting forcep 13 cm.
- 4- Grooved director with tounge tie 13 cm.
- 5- Triple chain hook.
- 6- Dressing scissors probe pointed 13 cm.
- 7- Probe double 13 cm.
- 8- Zipper case inside red velvet.

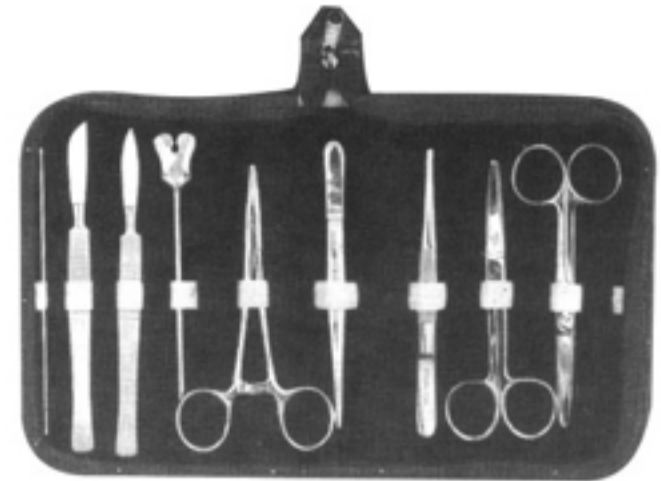

18-183

- 1- Probe Double 13 cm
- 2- 2 PCS. Scalpel S.S
- 3- Grooved Director With tongue Tie 13 cm
- 4- Mayo Hegar Needle Holder 13cm
- 5- Discting Forcep 13 cm 1x2 Teeth
- 6- Dressing Forcep 13 CMS Serrated.
- 7- Dressing Scissor 13 cm S/B STR.
- 8- Dressing Scissor 13 cm S/B CVD.
- 9- Zipper Case Inside Red Velvet.

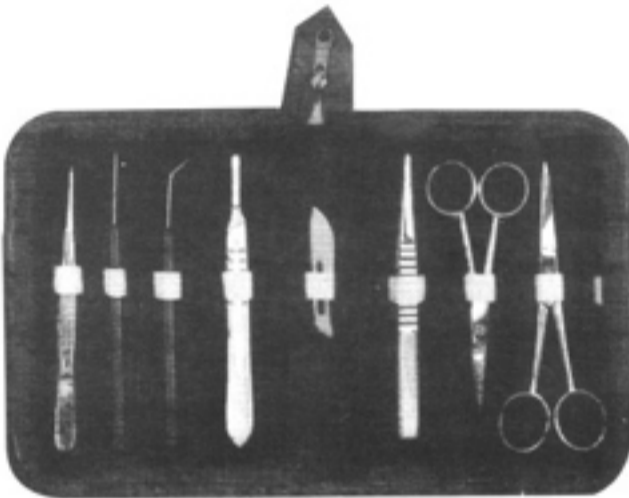

18-184

- 1- Dissecting Forcep 11.5 cm Sharp Point.
- 2- Iris Scissor
- 3- B.P Handle No. 4
- 4- Teasing Needle Sharp angular.
- 5- Blade No. 22
- 6- Thumb Forceps T.O.E 13 cm
- 7- Dissecting Scissor STR 11.5 cm
- 8- Dissecting Scissor STR 13 cm
- 9- Zipper case Inside Red Velvet

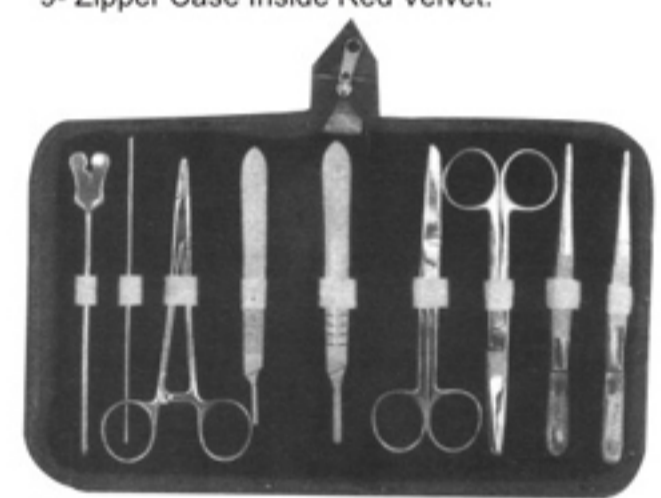

18-185

- 1- Grooved Director with Tongue Tie 14 cm
- 2- Probe Double 14cm
- 3- Mayo Hegar Needle Holder 14 cm
- 4- BP. Handle no.3
- 5- BP. Handle no.4
- 6- Dressing Scissor 14 cm S/B STR
- 7- Dressing Scissor 14 cm S/B CVD.
- 8- Dressing Forcep 1x2 Teeth 14 cm
- 9- Dressing Forcep Serrated 14 cm

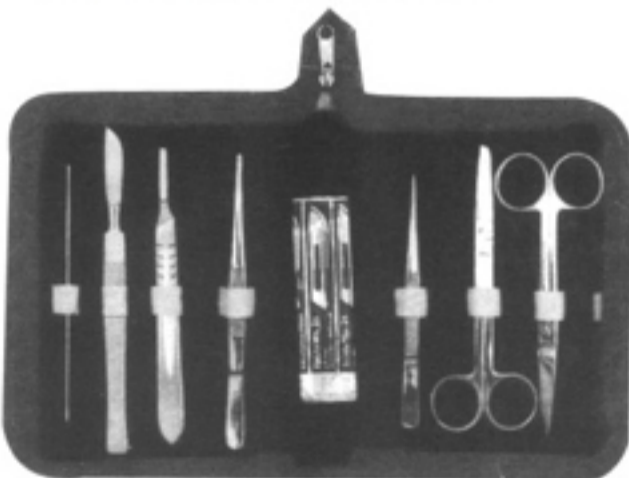

18-186

- 1- Probe double 12.5 cm
- 2- Scalpel
- 3- B.P Handle No. 4
- 4- 6 PCS Blade 2 each no. 21, 22, 23
- 5- Dissecting Forcep 12.5 cm
- 6- Dissecting Forcep 11.5 cm sharp Point
- 7- Dissecting Scissor S/B STR 13 cm
- 8- Dissecting Scissor S/S STR 13 cm

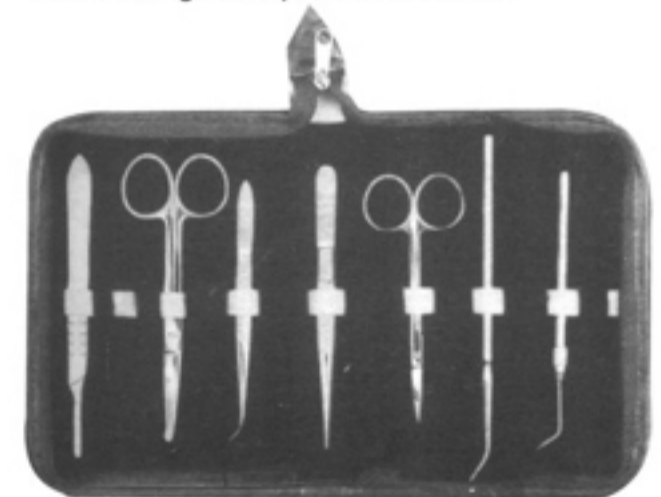

18-187

- 1- Teasing Needle with Chuck CVD.
- 2- Huber Probe
- 3- Iris Scissor
- 4- Dissecting Forcep Fine 14 cm.
- 5- Dissecting Forcep Fine CVD. 12 cm
- 6- Operating Scissor with Probe 14 cm.
- 7- B.P. Handle no. 4

Dissection Instruments



18-188

- 1- Probe with eye
- 2- Dissecting Forcep cvd fine 12 cm.
- 3- Iris Scissor
- 4- Operating Scissor S/B str 14 cm
- 5- Grooved Director and Tongue tie
- 6- Huber Probe
- 7- Triple Chain Hook
- 8- B.P Handle No. 4
- 9- B.P Handle No. 3
- 10- Teasing Needle with Chuck cvd.
- 11- Teasing Needle with Chuck str.
- 12- Dissecting Forceps Fine 14 cm.

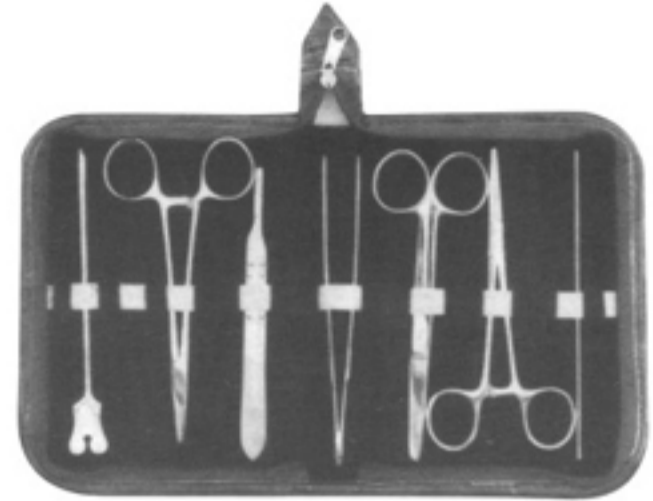

18-189

- 1- Grooved Director and Tongue tie
- 2- Mayo Harg Needle Holder 14 cm
- 3- B.P Handle No. 4
- 4- Dissecting Forceps Thump 14 cm.
- 5- Operating Scissor S/B str 14 cm
- 6- Kelly Forcep STR 14 cm.
- 7- Probe Double end

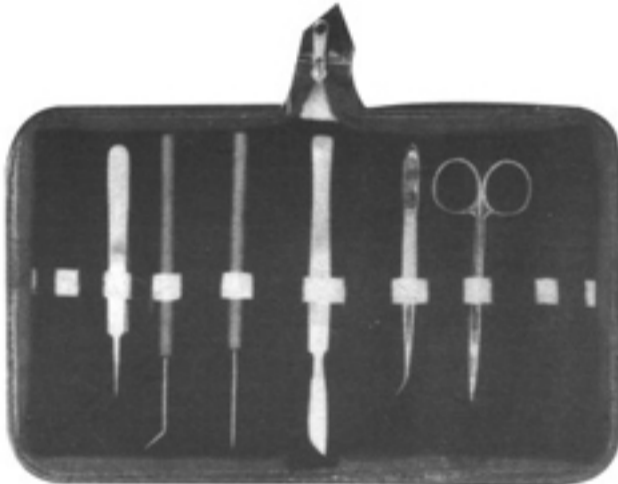

18-190

- 1- Iris Scissor STR
- 2- Dissecting Forceps CVD 12 cm.
- 3- Scalpel
- 4- Teasing Needle STR wooden handle.
- 5- Teasing Needle CVD wooden handle.
- 6- Watchmaker fine point.

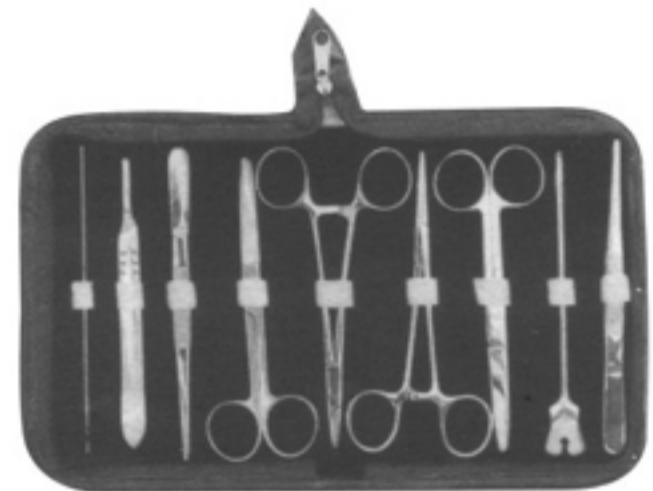

18-191

- 1- Probe Double end
- 2- B.P Handle No. 4
- 3- Dissecting Forcep 1x2 Teeth 14 cm.
- 4- Operating Scissor S/B str 14 cm
- 5- Mayo Harg Needle Holder 14 cm
- 6- Kelly Forcep STR 14 cm.
- 7- Operating Scissor S/B CVD 14 cm
- 8- Grooved Director and Tongue tie
- 9- Dissecting Forceps Thumb 14 cm.

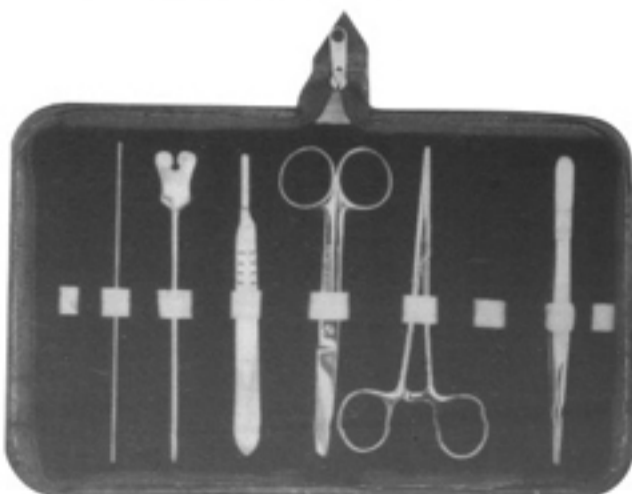

18-192

- 1- Probe double end.
- 2- Grooved director and tounge tie.
- 3- B.P handle no.4
- 4- Operating scissor STR S/b14cm.
- 5- Kelly forceps STR 14cm.
- 6- Dissecting forceps thumb 13cm.

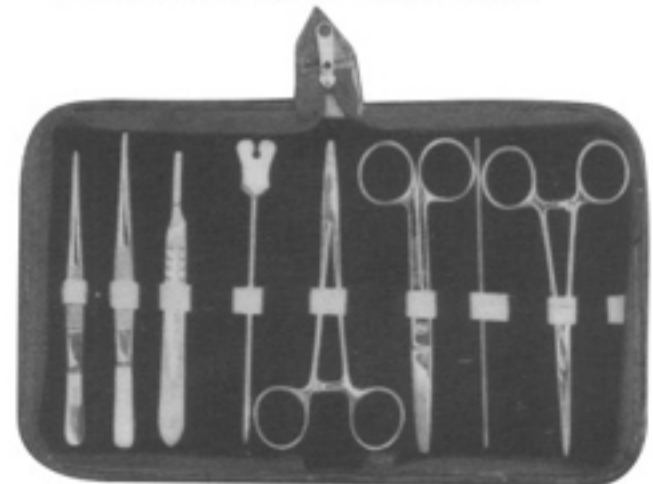

18-193

- 1- Dissecting Forceps Thumb 14 cm
- 2- Dissecting Forcep 1x2 Teeth 14 cm.
- 3- B.P Handle No. 3
- 4- Grooved Director and Tongue tie
- 5- Mayo Harg Needle Holder 14 cm
- 6- Operating Scissor S/B str 14 cm
- 7- Probe Double end
- 8- Kelly Forcep STR 14 cm.

Dissection Instruments

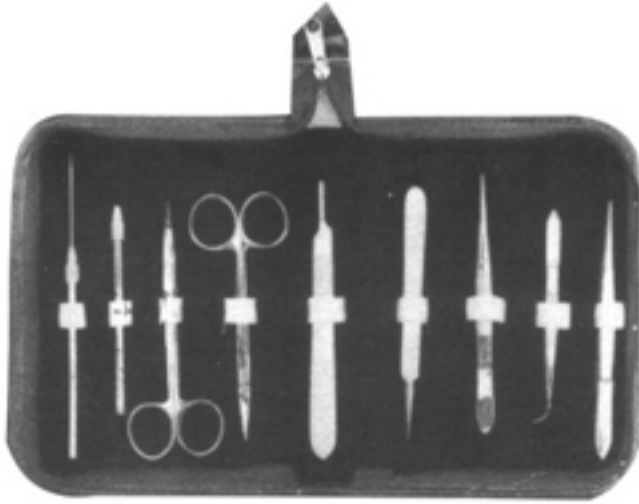

18-194

- 1- Dissecting Forcep Fine 14cm.
- 2- Dissecting Forcep Fine CVD 12cm
- 3- Dissecting Forcep with Pin 14cm.
- 4- Watchmaker Fine point
- 5- Iris scissor STR
- 6- Iris scissor CVD.
- 7- Teasing Needle holder
- 8- Teasing Needle STR.
- 9- B.P. Handle no. 3



18-195

- 1- Teasing Needle STR.
- 2- Grooved Director and Tongue Tie.
- 3- Teasing Needle CVD.
- 4- Dissecting Forcep with Pin 12 cm Fine
- 5- Operating Scissor S/B STR 14 cm
- 6- Triple Chain Hook
- 7- Probe with eye
- 8- Probe Double end
- 9- Probe and Hook
- 10- Dissecting Forcep Fine 14 cm
- 11- Iris Scissor
- 12- Huber Probe
- 13- B.P. Handle no.3
- 14- B.P. Handle no.4



18-196

- 1- Dissecting forcep fine STR with pin 12cm.
- 2- Iris scissor STR.
- 3- Probe with eye.
- 4- Probe and hook.
- 5- Operating scissor S/B STR 14cm
- 6- Triple chain hook.
- 7- B.P. handle no.4
- 8- Humber probe.
- 9- B.P.handle no.3
- 10- Teasing needle STR plastic handle.
- 11- Teasing needle CVD plastic handle.
- 12- Grooved director and tongue tie.
- 13- Probe double end.



18-197

- 1- Dissecting Forceps Thumb 14 cm.
- 2- Dissecting Forcep 1x2 Teeth 14 cm.
- 3- B.P Handle No. 3
- 4- Grooved Director and Tongue tie
- 5- Mayo Hearn Needle Holder 14 cm
- 6- Operating Scissor S/B str 14 cm
- 7- Probe Double end
- 7- Kelly Forcep STR 14 cm.

Hospital Wares



19-101 - 115
Schimmelbusch

	Ø x H sizes in mm
19-101	80 x 80
19-102	105 x 120
19-103	140 x 140
19-104	160 x 120
19-105	160 x 150
19-106	190 x 150
19-107	190 x 190
19-108	240 x 160
19-109	240 x 240
19-110	290 x 160
19-111	290 x 240
19-112	340 x 160
19-113	340 x 340
19-114	390 x 190
19-115	390 x 290



19-116
Box
120 x 65 x 13mm
(without Bulldog clamps,
without silicone tape)



19-117
Box with support
120 x 65 x 13 mm
(ohne Bulldogklemmen)



19-118
Box with support for
needle electrodes,
without instruments

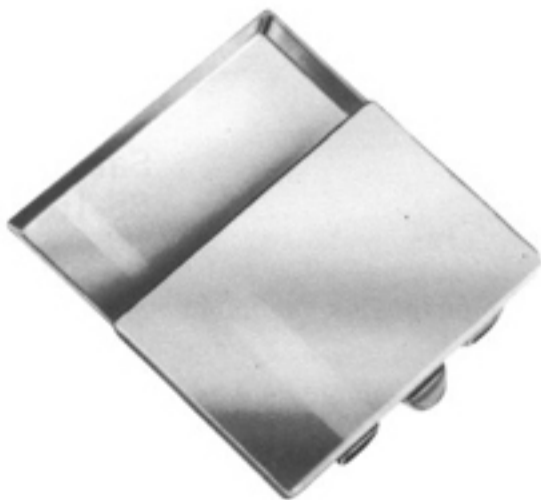

19-119 - 121
50 x 25 x 4,5 mm
19-120
65 x 42 x 8 mm
19-121
75 x 25 x 4,5 mm



19-122
Ø 65mm x 15mm

Hospital Wares



19-123 - 131

	Ø x H
19-123	30 x 90 mm
19-124	50 x 100 mm
19-125	50 x 130 mm
19-126	50 x 175 mm
19-127	75 x 100 mm
19-128	75 x 130 mm
19-129	75 x 175 mm
19-130	100 x 175 mm
19-131	100 x 200 mm



19-141 - 142

- 19-141** Martin Sterilizing Forceps consisting of:
 1 Sterilizing Forceps, curved, 25 cm, without ratchet, with lid for jar
 1 jar with bottom plate (anti-tilt)
- 19-142** ditto, with 32 cm long Sterilizing Forceps



19-132 - 139

19-132	165 x 85 x 35 mm
19-133	200 x 100 x 35 mm
19-134	200 x 100 x 50 mm
19-135	230 x 130 x 50 mm
19-136	260 x 150 x 50 mm
19-137	270 x 235 x 50 mm
19-138	300 x 200 x 50 mm
19-139	325 x 275 x 50 mm



19-140
 205 x 105 x 35 mm

Round Metal Boxes and Medicine Cups



19-143 - 148

	Ø x H
19-143	75 x 60 mm
19-144	75 x 75 mm
19-145	100 x 60 mm
19-146	100 x 100 mm
19-146A	125 x 80 mm
19-147	125 x 125 mm
19-148	150 x 150 mm



19-149
25 cc

19-150
50 cc



19-151
20 cc
Medicine Spoon



19-152
Ø 75 x 12 mm
Tablet Tray



19-153
Ø 90 x 90 mm
Metal Cup



19-154
Ø 75 x 80 mm
Sputum Cup

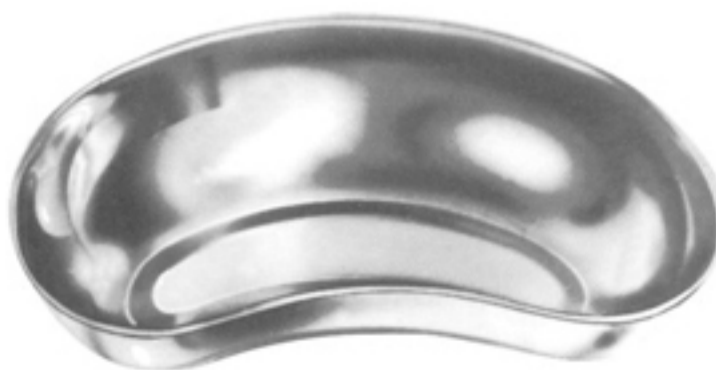

Kidney Dish



19-155 - 157

19-155	170 x 100 x 35 mm
19-156	250 x 140 x 40 mm
19-157	275 x 150 x 45 mm

Hospital Wares



19-158 - 165

	Ø x H		
19-158	40 x 19	mm	0.05L
19-159	61 x 30	mm	0.07L
19-160	80 x 40	mm	0.14L
19-161	116 x 50	mm	0.35L
19-162	128 x 55	mm	0.45L
19-163	147 x 65	mm	0.70L
19-164	167 x 75	mm	1.10L
19-165	187 x 85	mm	1.60L



19-166 - 170

19-166	116 x 35	mm	0.30L
19-167	128 x 38	mm	0.40L
19-168	147 x 40	mm	0.50L
19-169	157 x 45	mm	0.75L
19-170	187 x 45	mm	1.00L



19-171
 Ø 110 x 28 mm 0.15L



19-172
 100 cc 0.1L



19-173 - 176
19-173 0,25L
19-174 0,50L
19-175 1,00L
19-176 2,00L



19-177
 235 x 190 x 40 mm



19-178
 Ø 220 x 70 mm

Hospital Wares



19-179
∅ 50 x 100 mm
Powder Pot



19-180
∅ 50 x 75 mm
Methot With Lid



19-181
∅ 50 x 75 mm
Methot Without Lid



19-182



19-183



19-184



19-185 - 186

19-185 ∅ 235 mm
19-186 ∅ 310 mm

Needle Cases



19-187
Sauerbruch
210 x 125 x 17 mm



19-188
Sauerbruch
210 x 125 x 17 mm



19-189
150 x 95 x 13 mm



19-190
150 x 95 x 13 mm



19-191
150 x 95 x 13 mm



19-192
150 x 95 x 13 mm



19-193
150 x 95 x 13 mm



19-194
150 x 95 x 13 mm



19-195
150 x 95 x 11 mm

Storing Cases



19-199 - 209

19-199	230 x 130 x 50	mm
19-200	260 x 150 x 50	mm
19-201	275 x 235 x 50	mm
19-202	300 x 200 x 50	mm
19-203	325 x 275 x 50	mm
19-204	420 x 175 x 50	mm
19-205	230 x 130 x 75	mm
19-206	260 x 150 x 75	mm
19-207	300 x 200 x 75	mm
19-208	325 x 275 x 75	mm
19-209	420 x 175 x 75	mm



19-196
 Deponette
 245 x 135 x 35mm



19-197
 Deponette
 245 x 135 x 50mm



19-198
 Deponette
 245 x 135 x 60mm

Sterilizing Baskets / Trays



19-210 - 212

19-210	480 x 250 x 50	mm
19-211	520 x 250 x 75	mm
19-212	520 x 250 x 100	mm

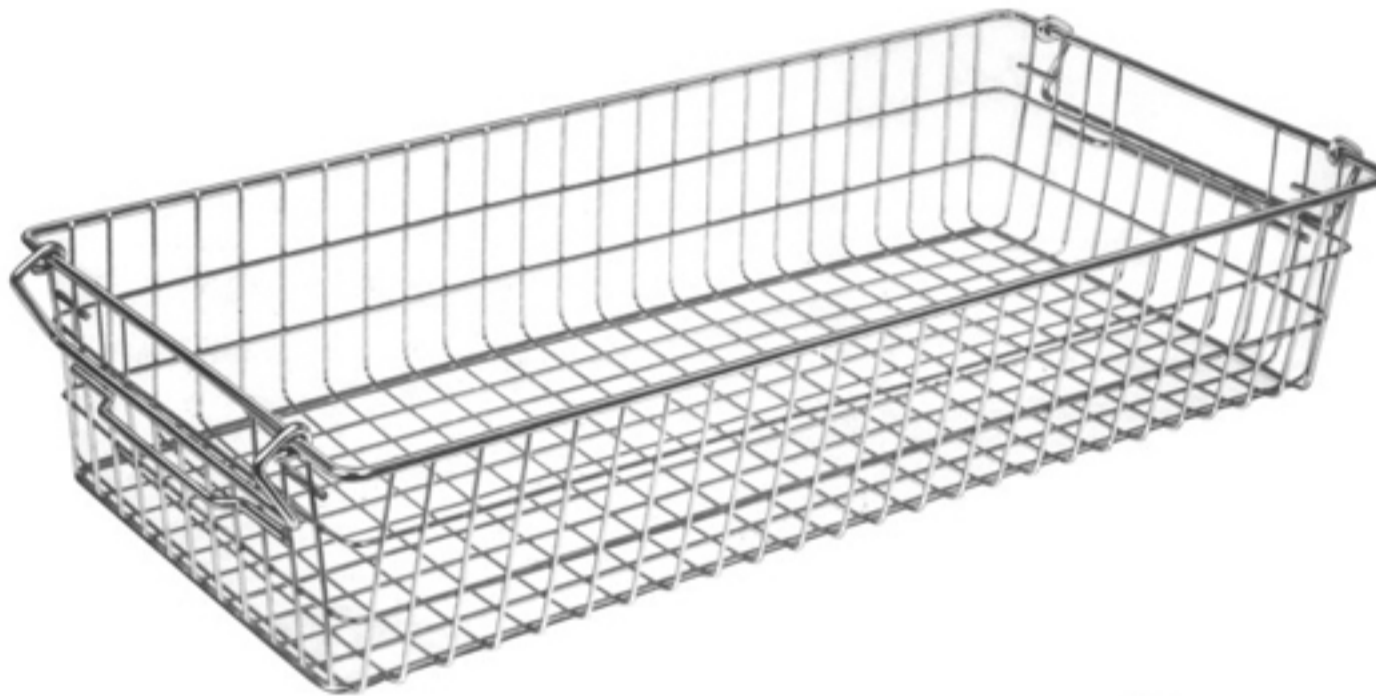

19-219
 (60 x 30 x 15 cm)
 Nominal dimensions



19-213 - 218

19-213	240 x 240 x 50	mm
19-214	240 x 240 x 80	mm
19-215	240 x 240 x 100	mm
19-216	480 x 260 x 50	mm
19-217	520 x 260 x 80	mm
19-218	520 x 260 x 100	mm

Scissors with Tungsten Carbide Inserts

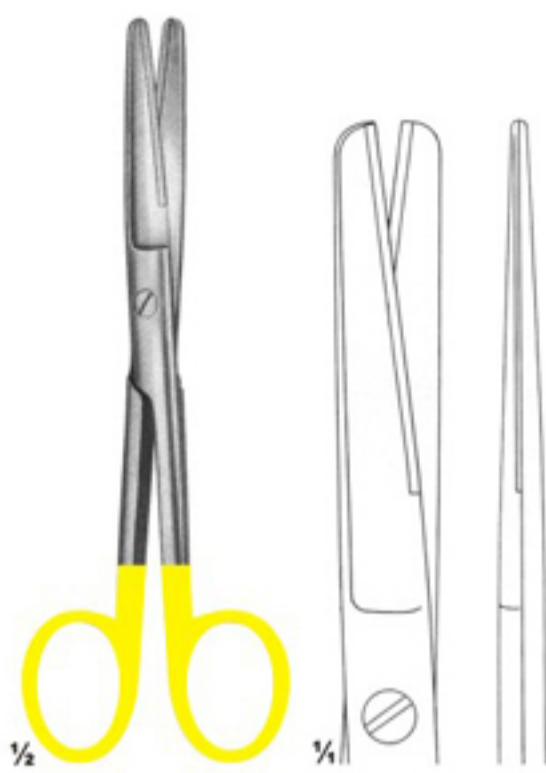

26-101
Standard

14,5cm
16,5cm
18,5cm



26-102
Standard

14,5cm
16,5cm
18,5cm



26-103
Standard

14,5cm
16,5cm
18,5cm

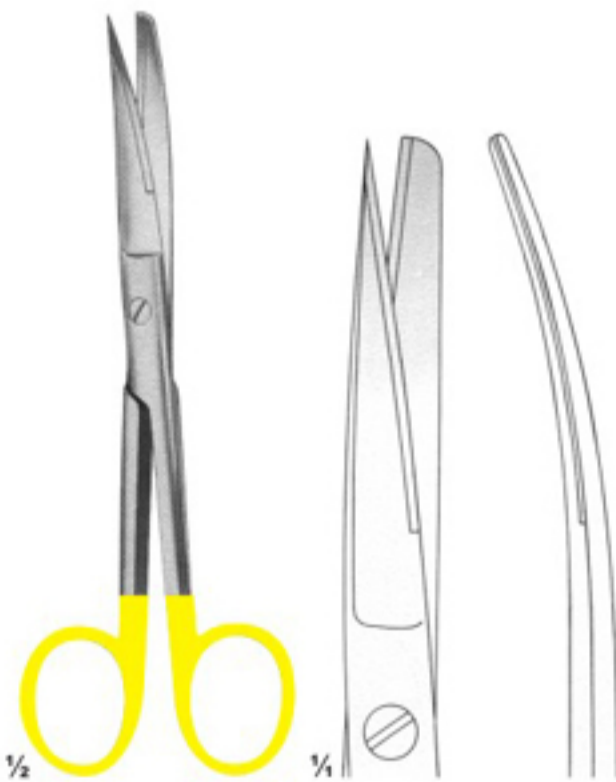

26-104
Standard

14,5cm
16,5cm
18,5cm



26-105
Standard

14,5cm
16,5cm
18,5cm



26-106
Standard

14,5cm
16,5cm
18,5cm

Scissors with Tungsten Carbide Inserts

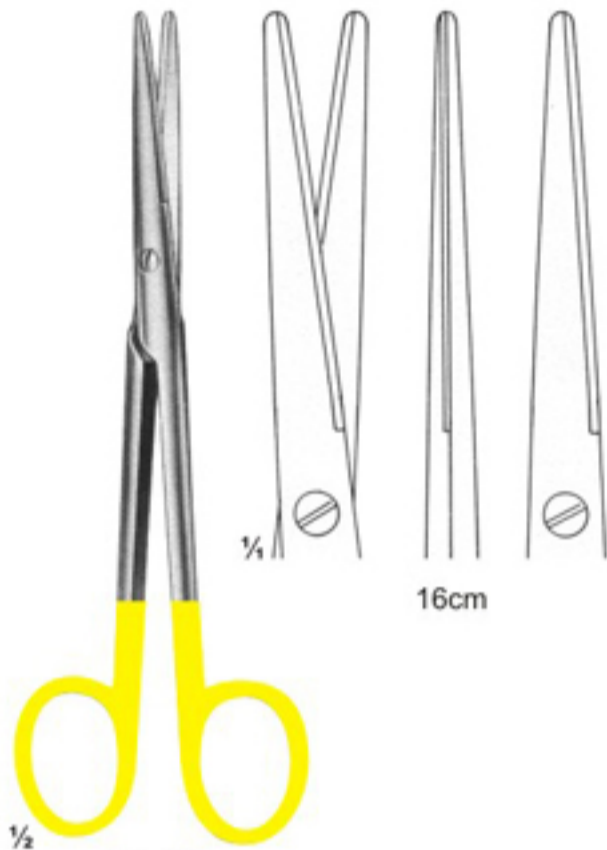

26-107
Mayo-Lexer

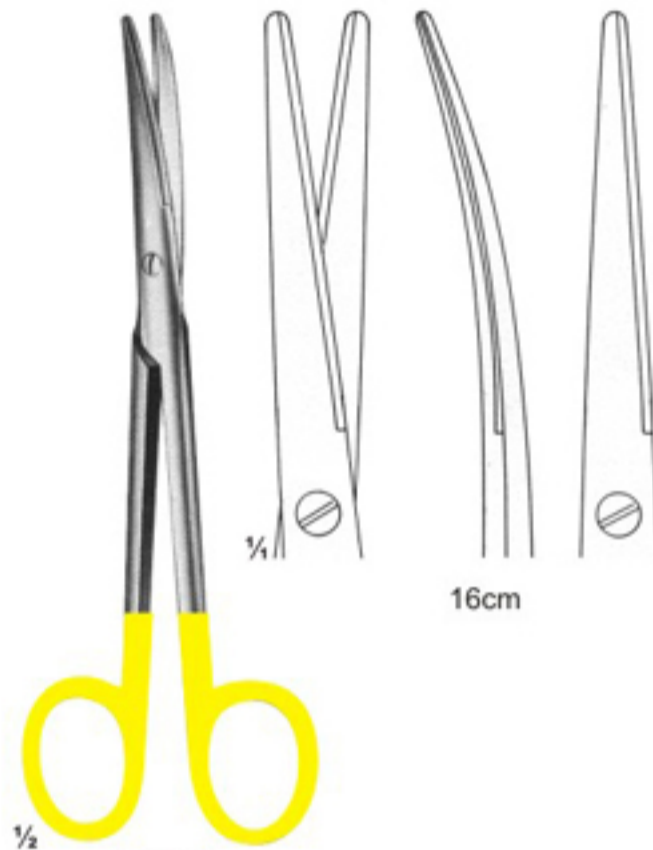

26-108
Mayo-Lexer

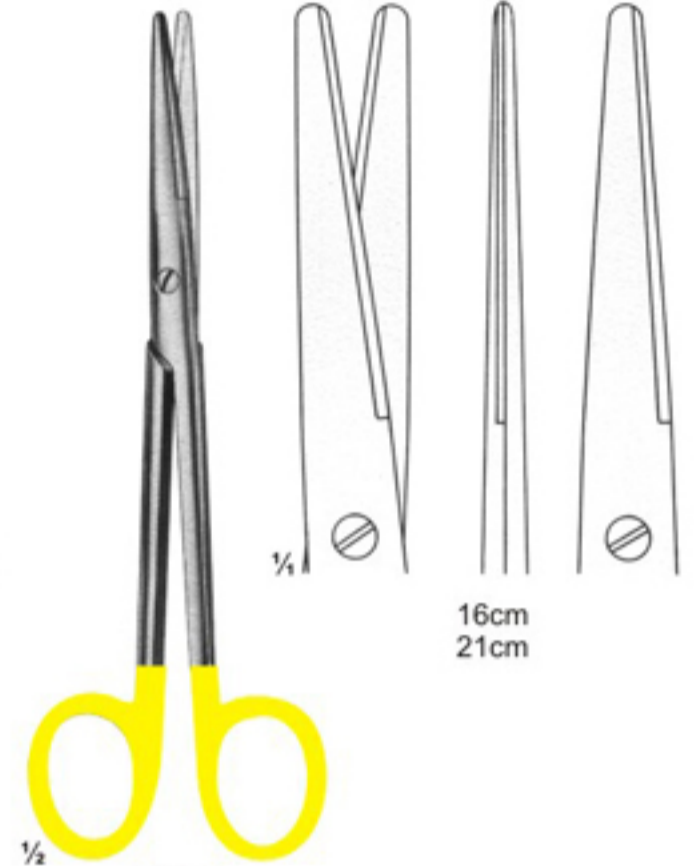

26-109
Lexer

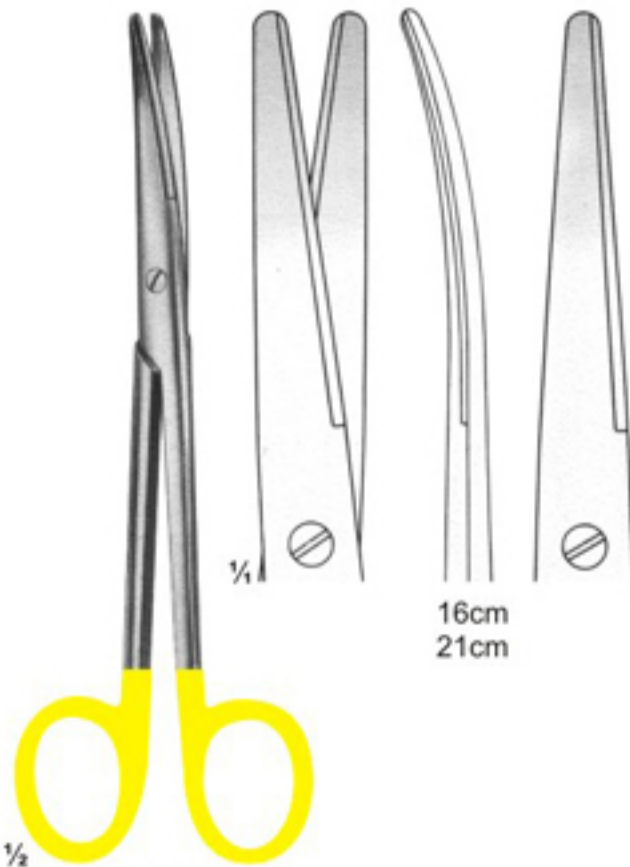

26-110
Lexer

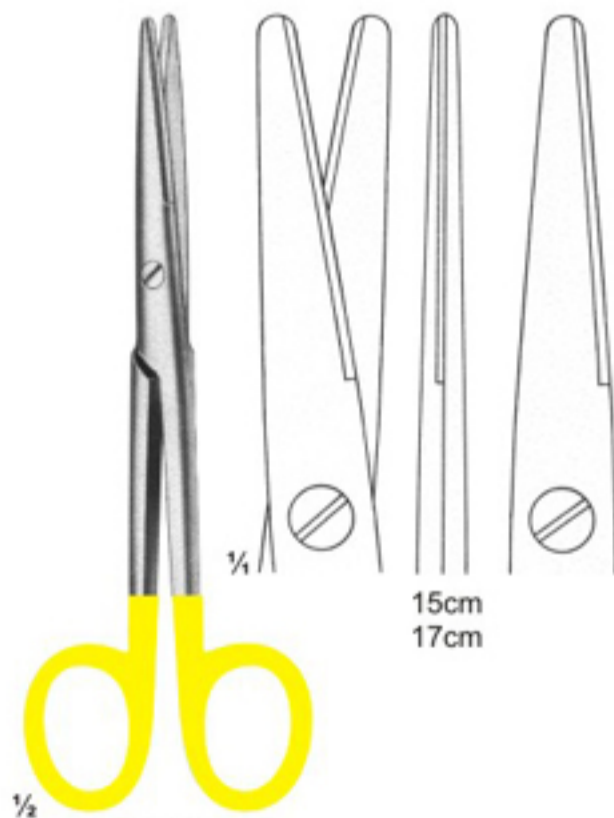

26-111
Mayo-Stille

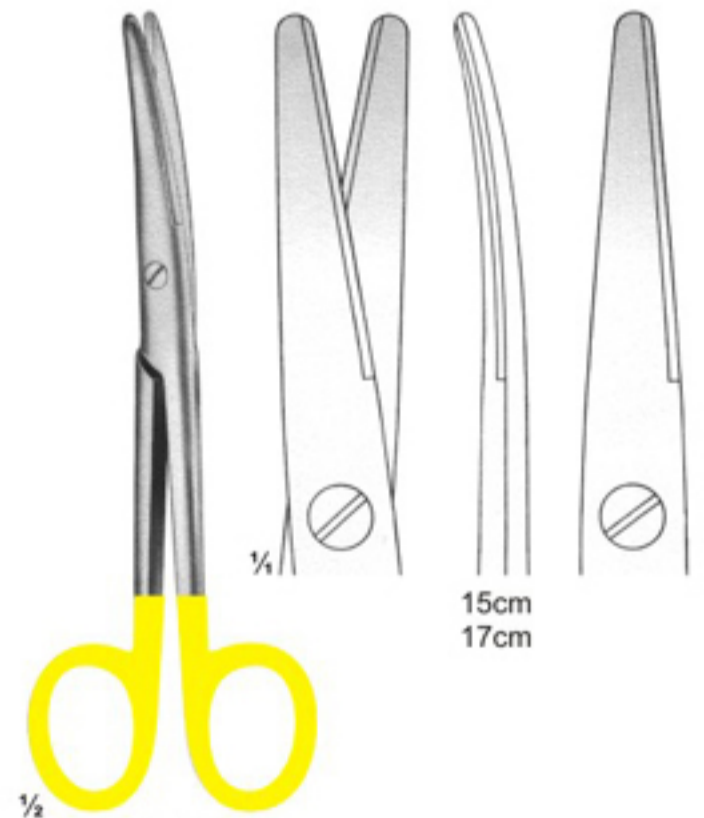

26-112
Mayo-Stille

Scissors with Tungsten Carbide Inserts



26-113
Metzenbaum

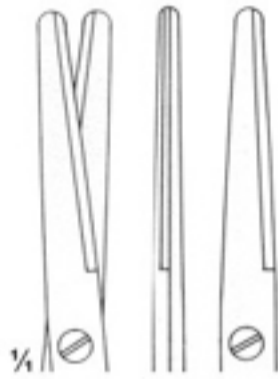

18cm 11,5cm
 20cm 14,5cm
 28cm 23,5cm
 30cm 25,5cm



26-114
Metzenbaum



11,5cm 14,5cm
 23cm 25cm

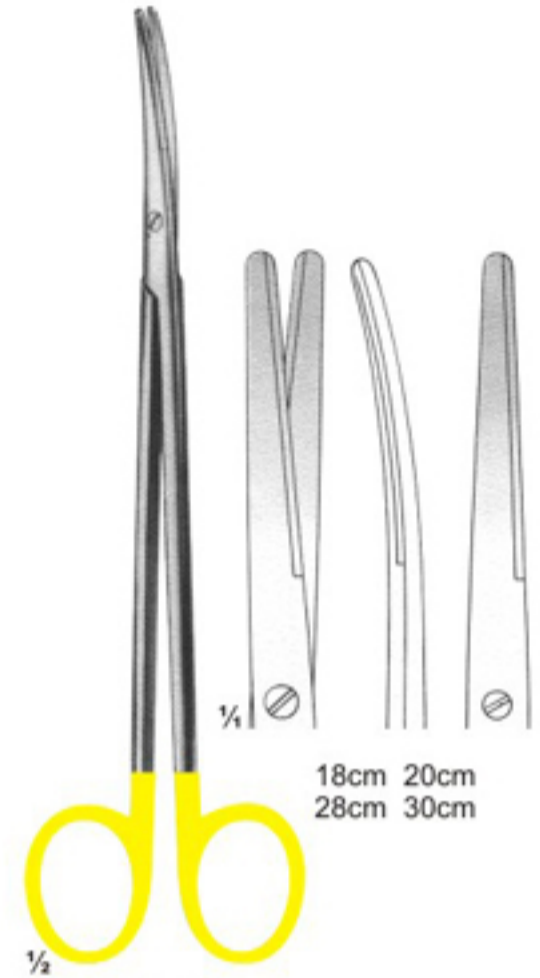

26-115
Metzenbaum



18cm 20cm
 28cm 30cm



26-116
Metzenbaum-Fino

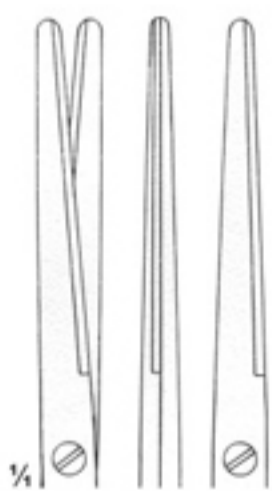

14cm 18cm 20cm
 23cm 25cm 28cm



26-117
Metzenbaum-Fino



14cm 18cm 20cm
 23cm 25cm 28cm

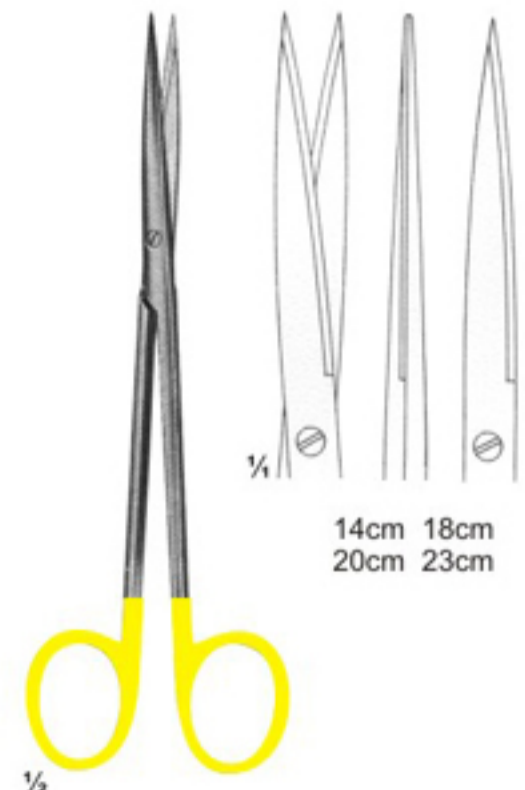

26-118
Metzenbaum-Fino



14cm 18cm
 20cm 23cm

Scissors with Tungsten Carbide Inserts



1/2
26-119
Metzenbaum-Fino

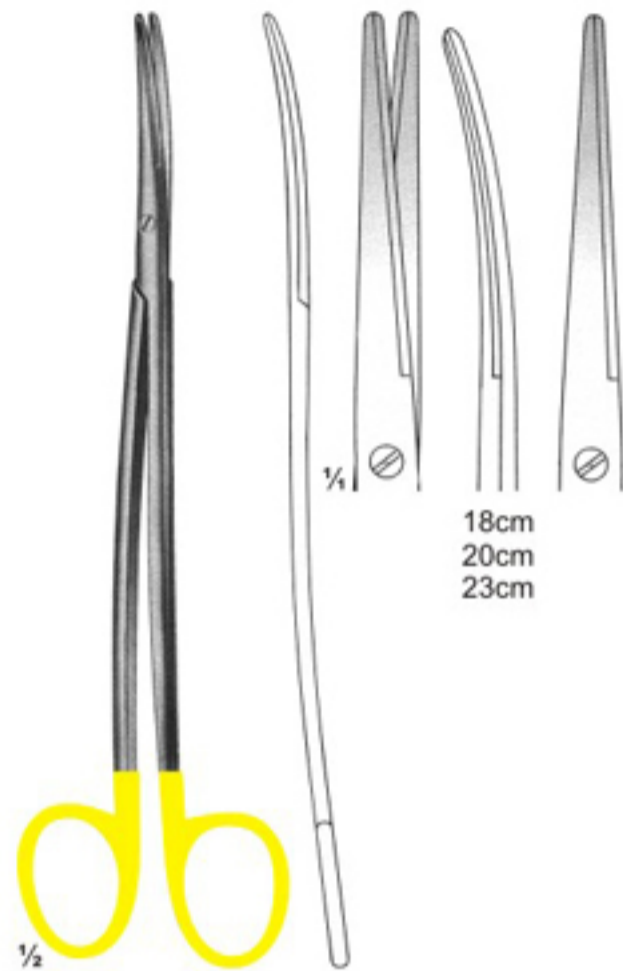

1/2
26-120
Metzenbaum-Fino

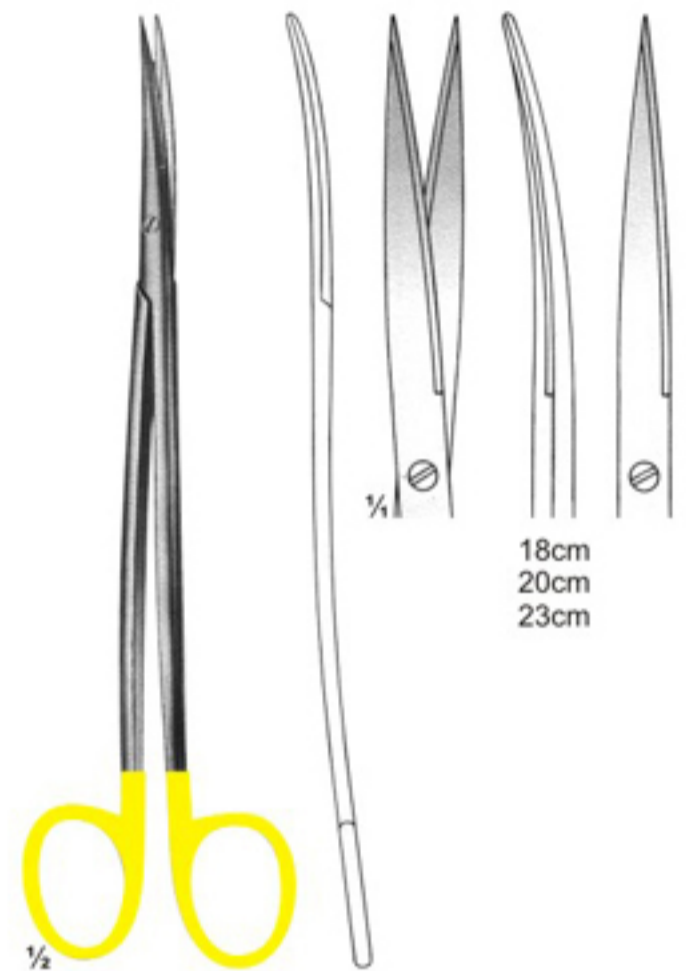

1/2
26-121
Metzenbaum-Fino

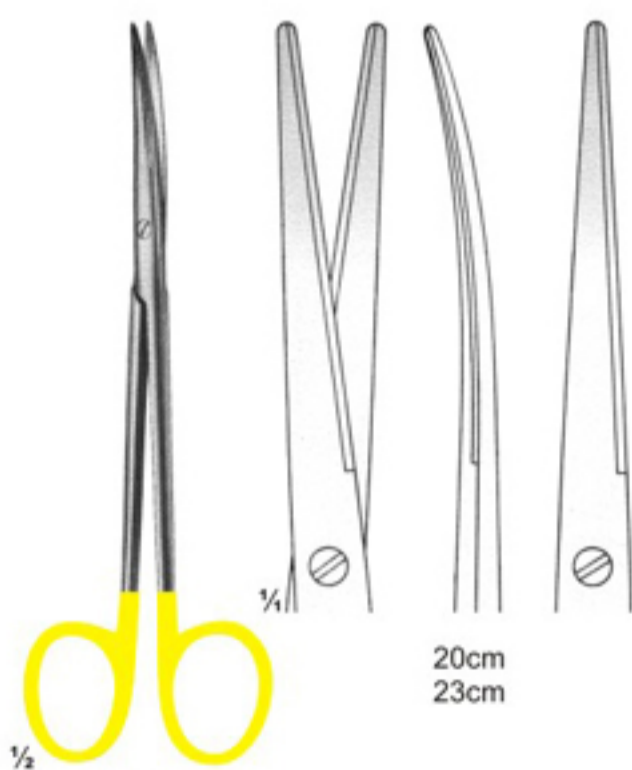

1/2
26-122
Metzenbaum

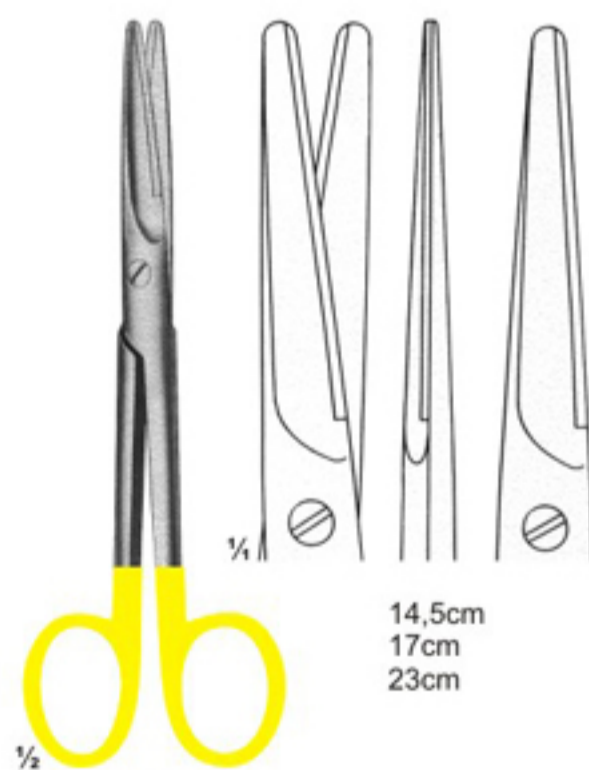

1/2
26-123
Mayo

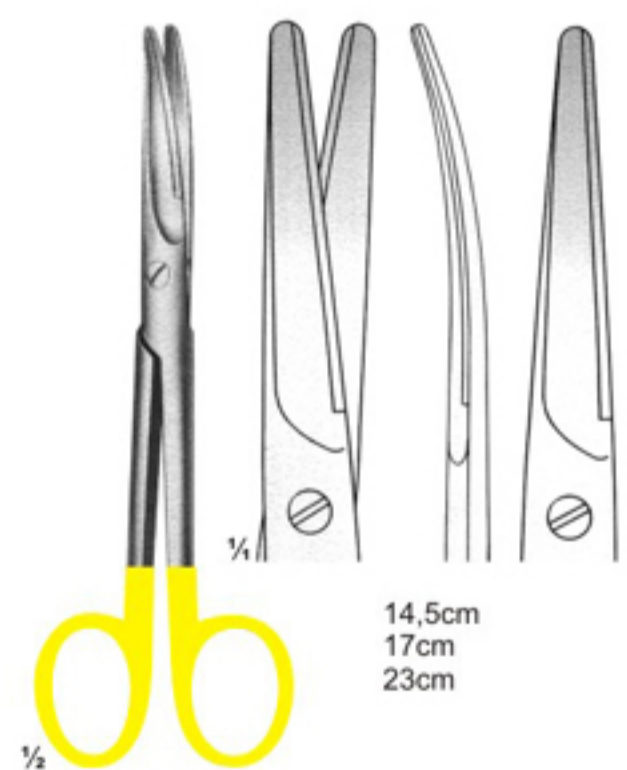

1/2
26-124
Mayo

Scissors with Tungsten Carbide Inserts

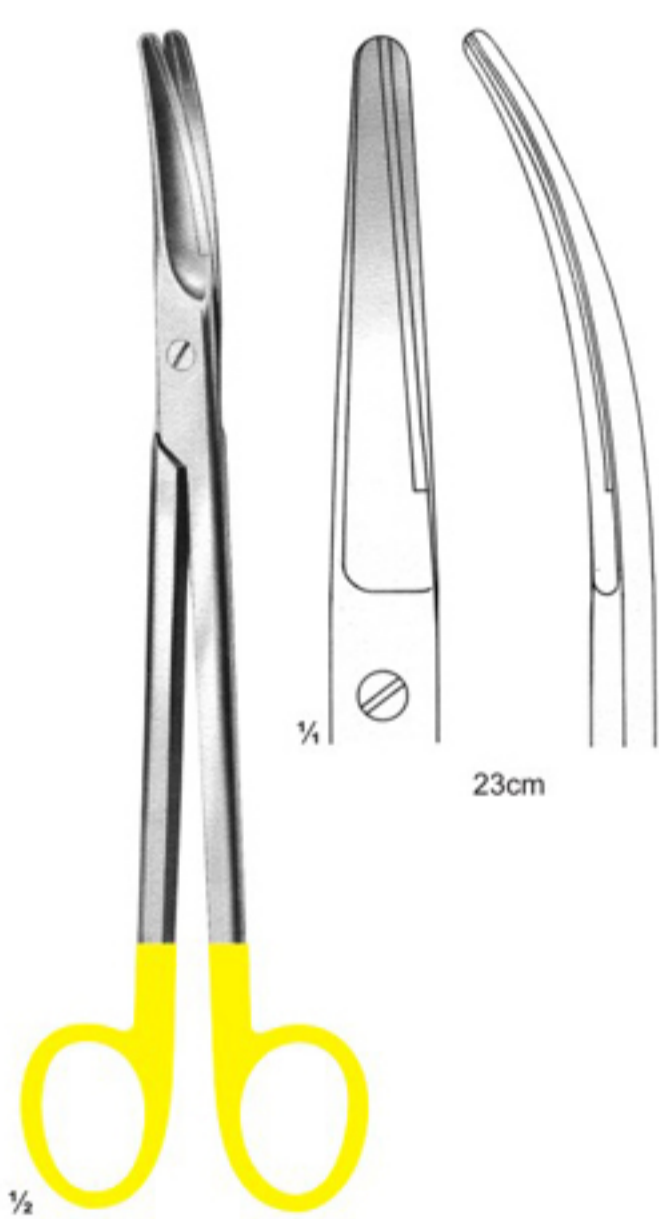

26-125
Parametrium

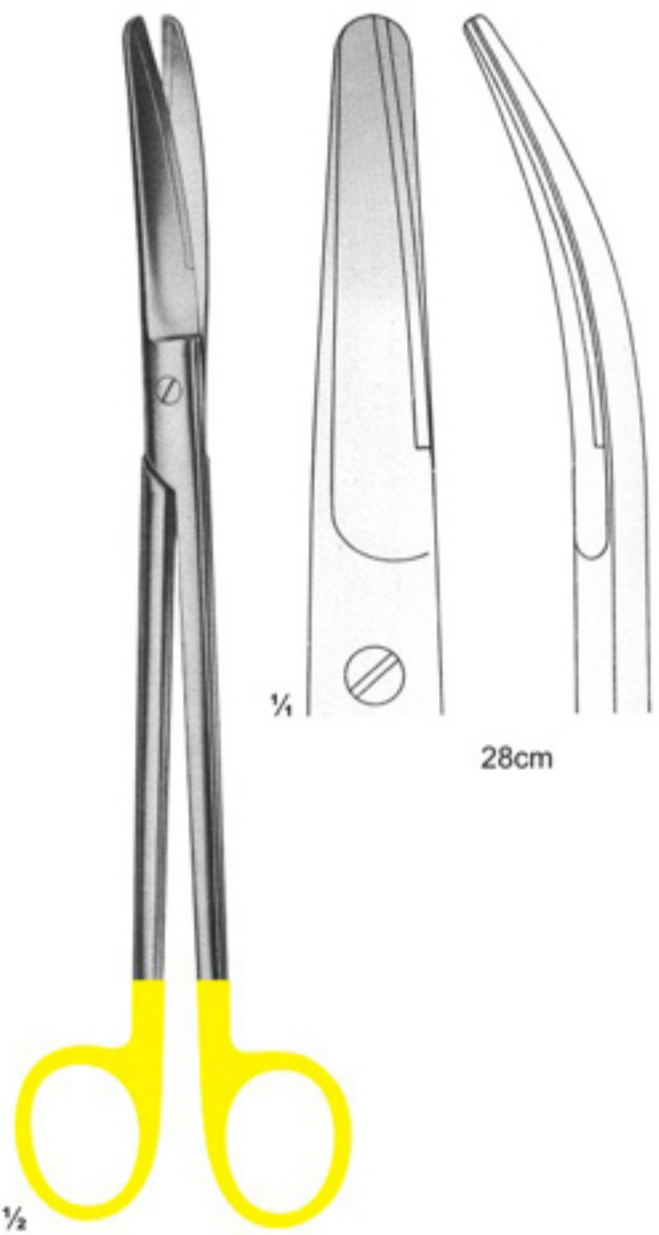

26-126
Mayo-Harrington

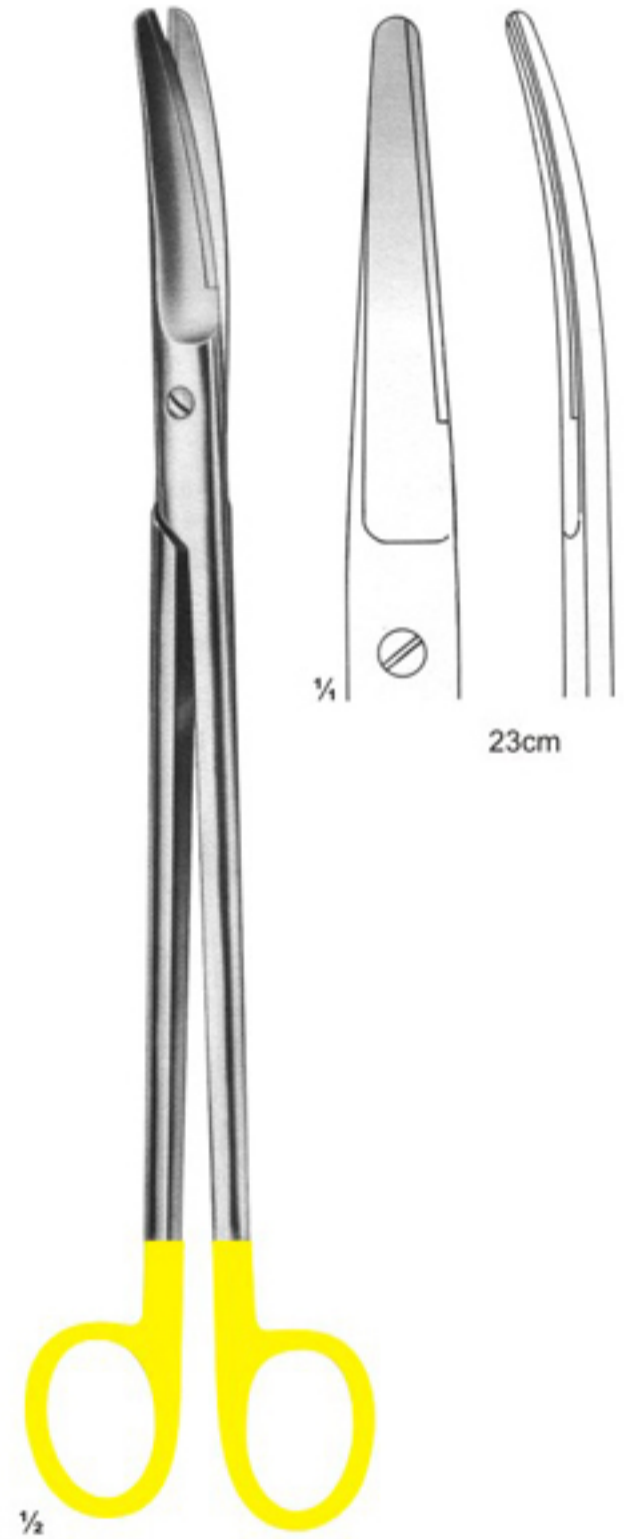

26-127
Sims

Scissors with Tungsten Carbide Inserts

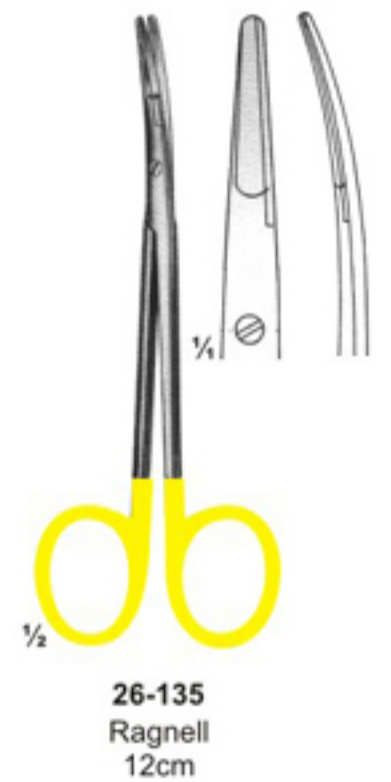
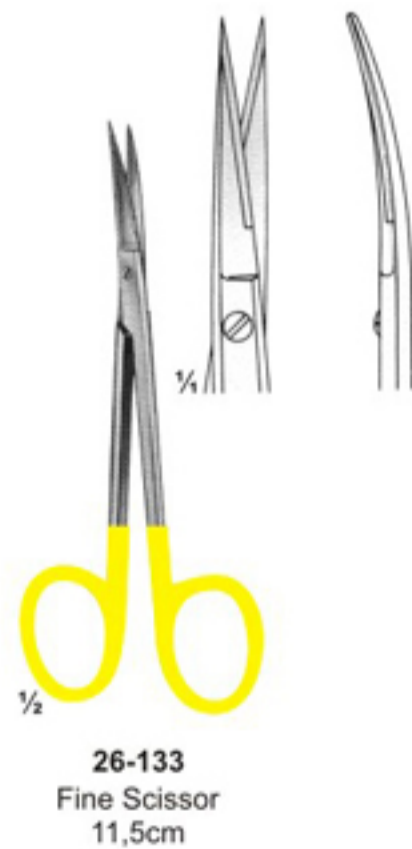
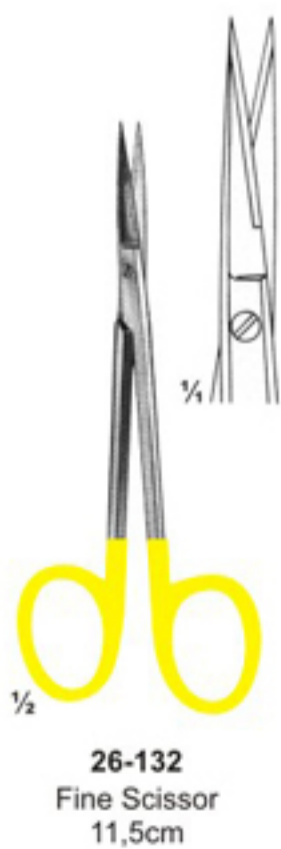
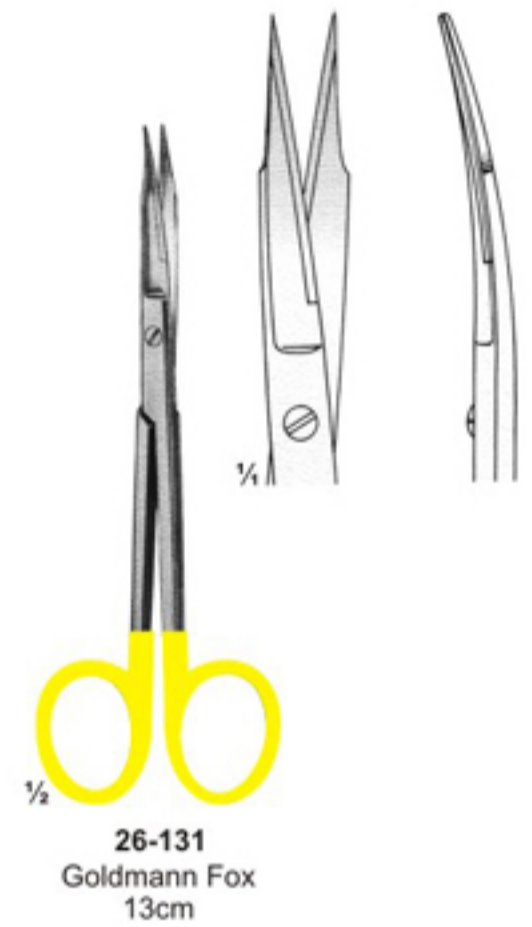
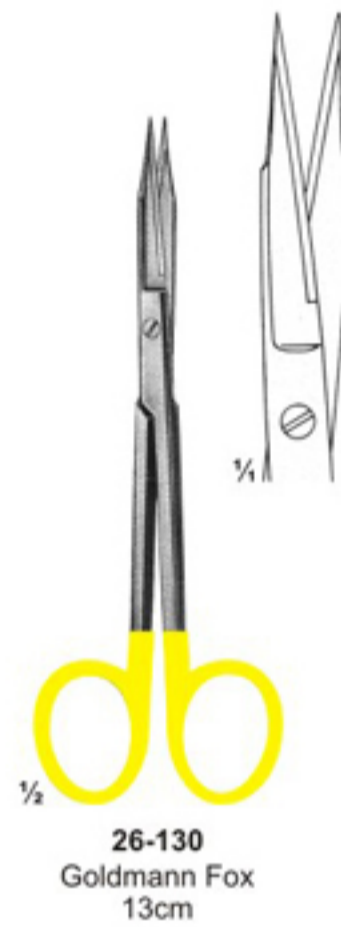
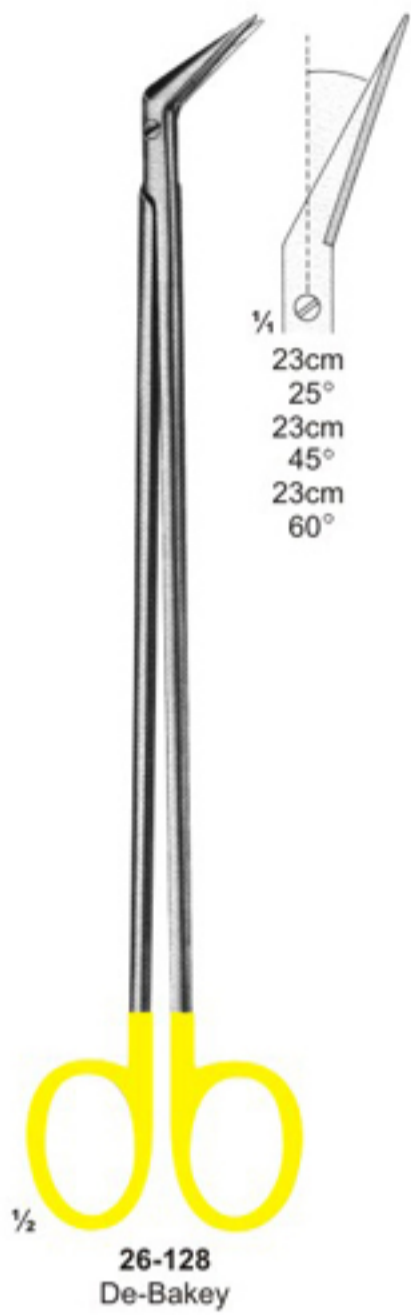

Scissors & Dissecting Forceps with Tungsten Carbide Inserts

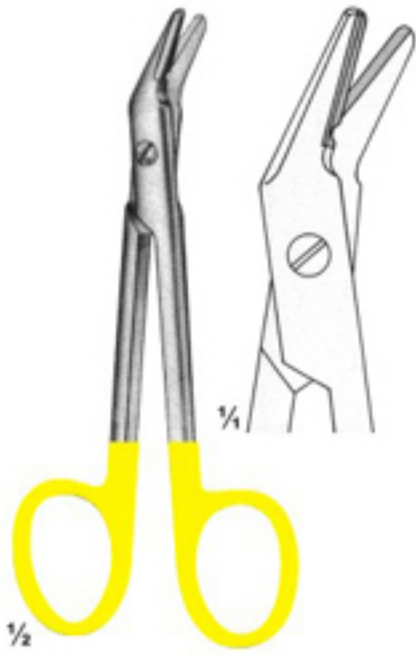

26-136
Universal
12cm

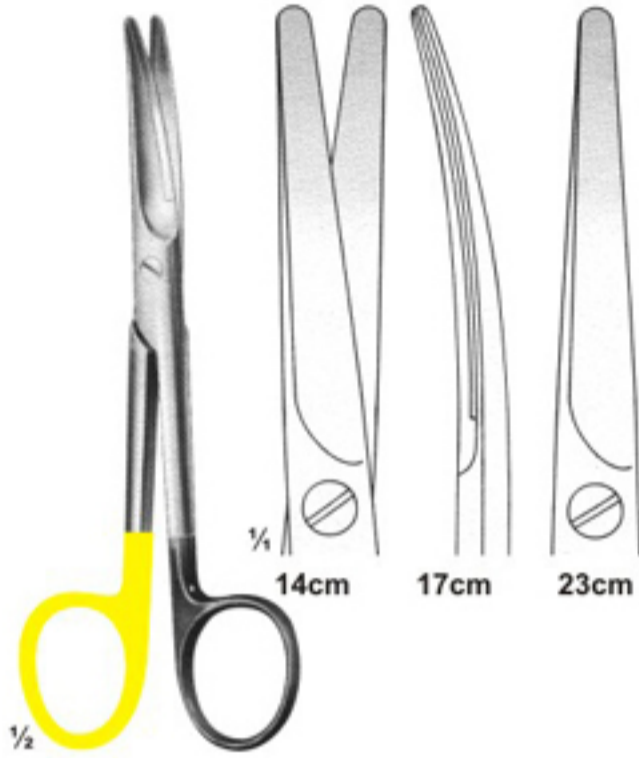

26-137
Ligature Scissors
1 Black & 1 Goldplated ring

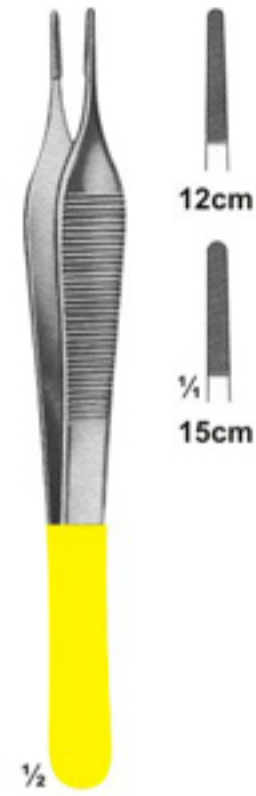

26-138
Adson



26-139
Cushing
17,5cm



26-140
Cushing
18cm



26-141
Cushing-Taylor
18cm



26-142
Dissecting Forceps
15cm



26-143
Semken
15cm

Dissecting Forceps and Needle holders with



26-144
Wangenstein

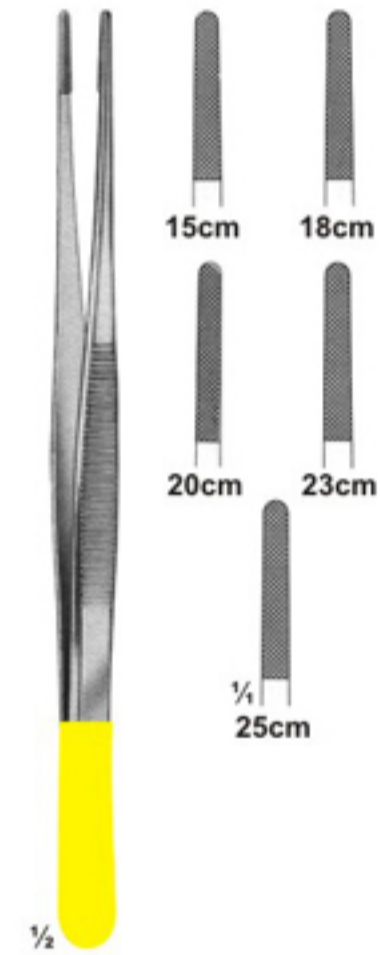

26-145
Potts-Smith

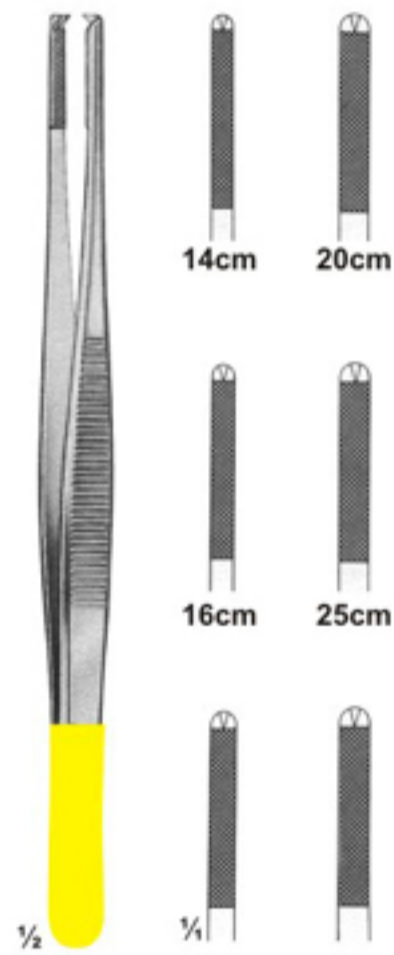

26-146
Oehler



26-147
Potts-Smith
22cm



26-148
Hepp-Scheidle
18cm



26-149
Castroviejo
14cm



26-150
Castroviejo
14cm



26-151
Arruga
16cm

Needle holders with Tungsten Carbide Inserts



26-152
 Arruga
 16cm



26-153
 Castroviejo
 13cm

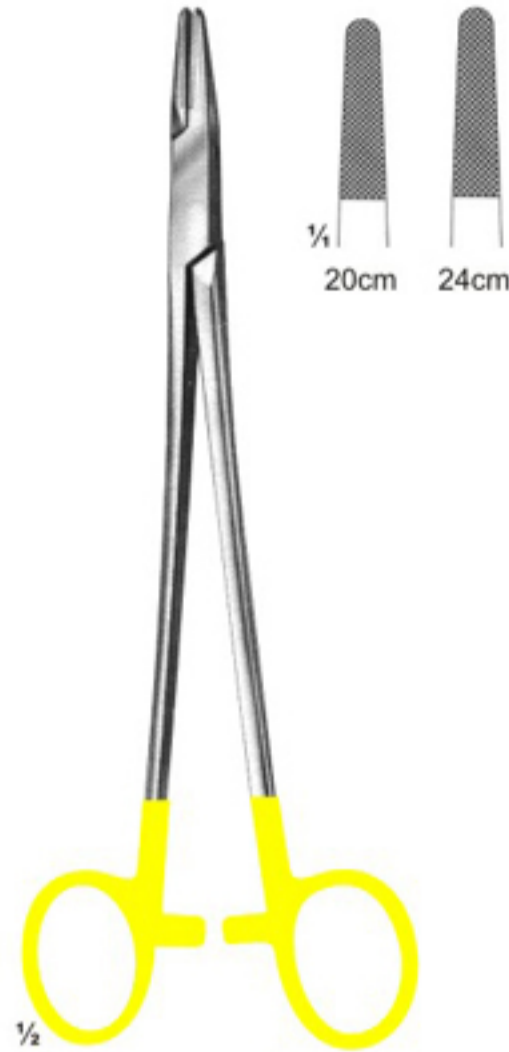

26-154
 Hegar
 20cm 24cm

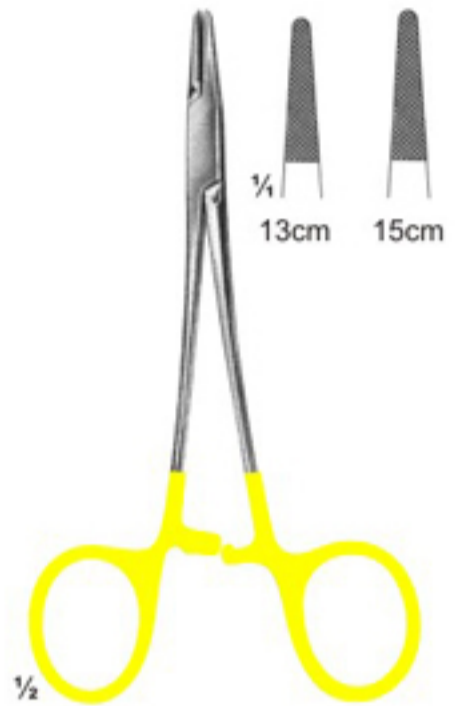

26-155
 Halsey
 13cm 15cm



26-156
 Mayo-Hegar
 16cm 18cm 20cm
 24cm 26cm 30cm

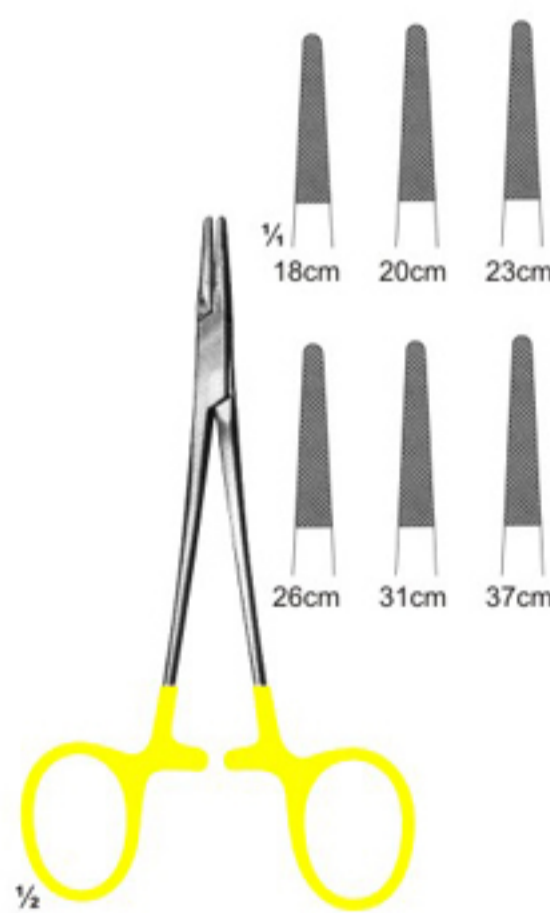

26-157
 De-Bakey
 18cm 20cm 23cm
 26cm 31cm 37cm

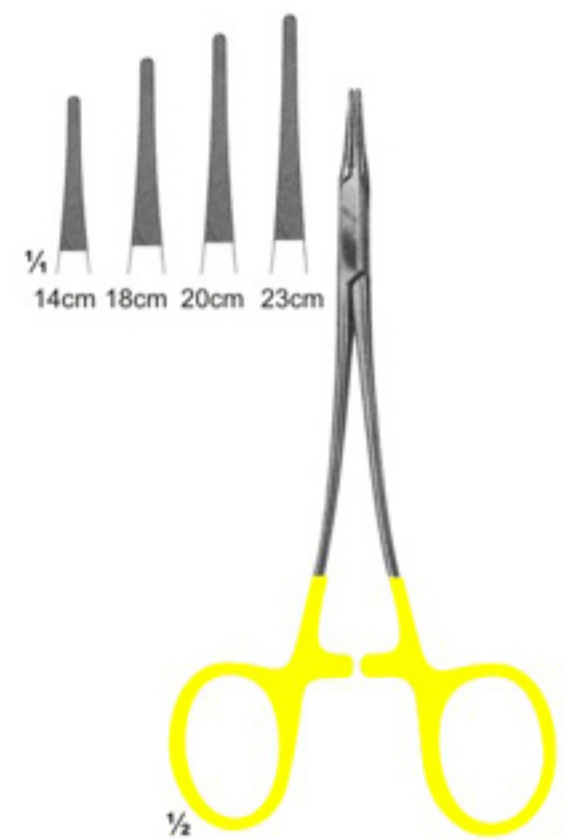

26-158
 Hegar-Vascular
 14cm 18cm
 20cm 23cm

Needle holders with Tungsten Carbide Inserts

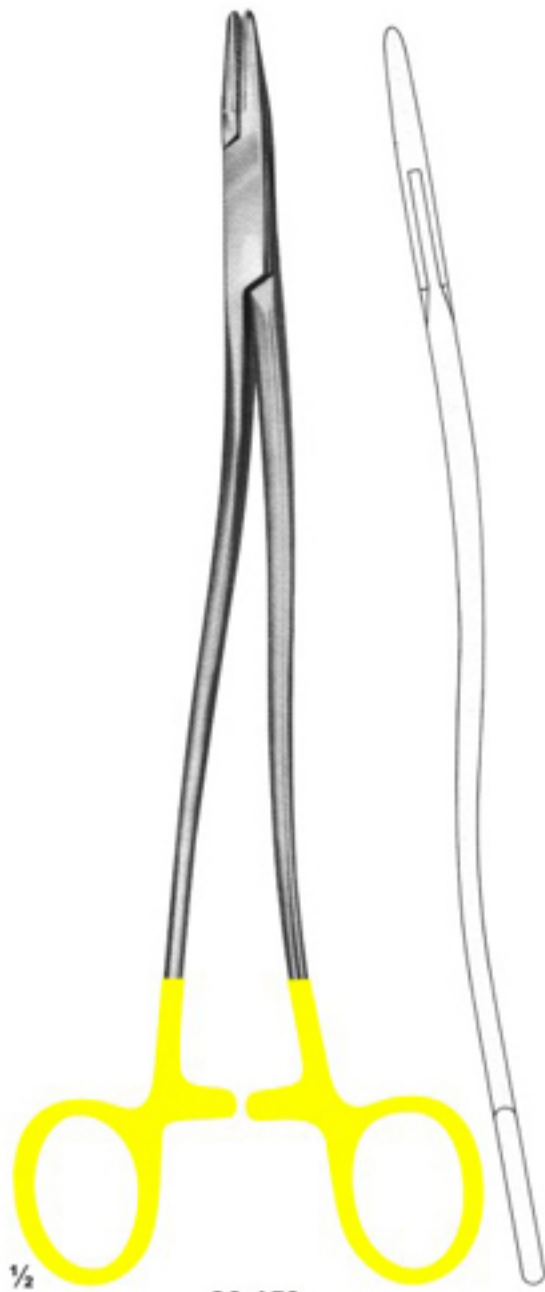

$\frac{1}{2}$
26-159
Bozemann-Wertheim
20cm 24cm 26cm



$\frac{1}{2}$
26-160
Stratte
22cm 23cm

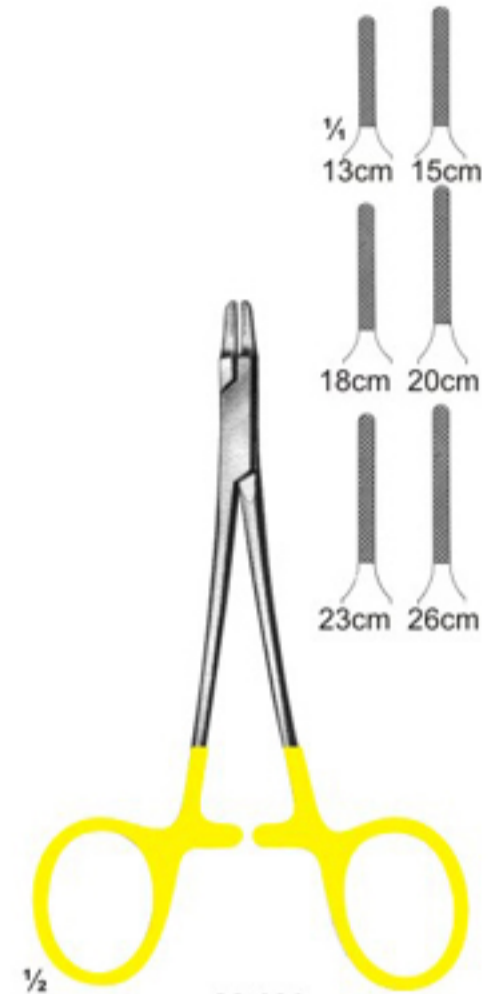

$\frac{1}{2}$
26-161
Ryder
13cm 15cm 18cm
20cm 23cm 26cm



$\frac{1}{2}$
26-162
Ryder-Vascular
13cm 15cm 18cm
20cm 23cm 26cm



$\frac{1}{2}$
26-163
Martin
15cm 17cm 20cm



$\frac{1}{2}$
26-164
Sarot
18cm 20cm 26cm

Needle holders with Tungsten Carbide Inserts

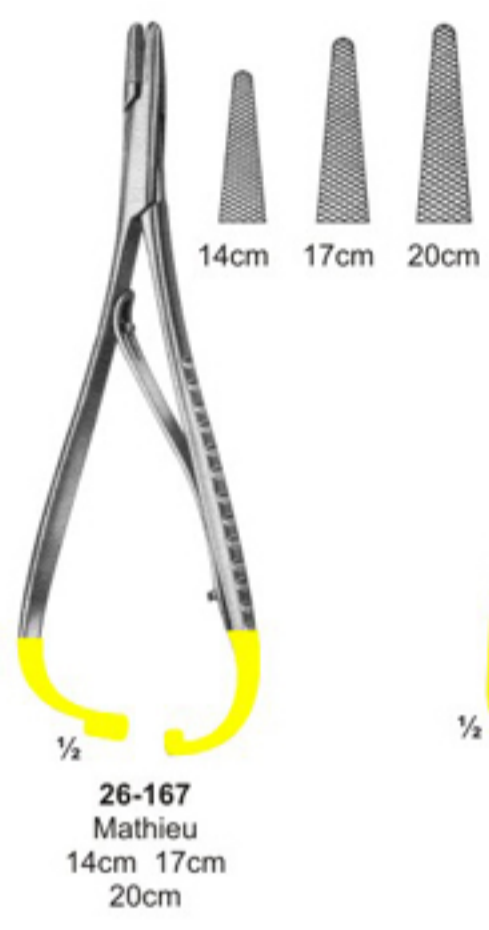

Needle holders with Tungsten Carbide Inserts



1/2
26-172
Mathieu-Ryder
17cm
20cm 24cm



1/2
26-173
Lichtenberg
20cm



1/2
26-174
Langhals
20cm 25cm



1/2
26-175
Lichtenberg
20cm 25cm



1/2
26-176
Luehty-Beck
20cm 25cm



1/2
26-177
Luehty-Beck
20cm 25cm



1/2
26-178
Langebeck
18cm
20cm 23cm

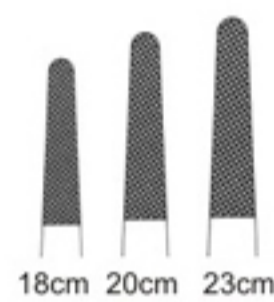

1/2
26-179
Langebeck-beck
18cm
20cm 23cm

Wire Cutting Plier With T.C. Inserts



26-180
TOENNIS
Elastic pattern for
dura-or intestinal suture
180 mm



26-181
Cutting Plier
12 cm

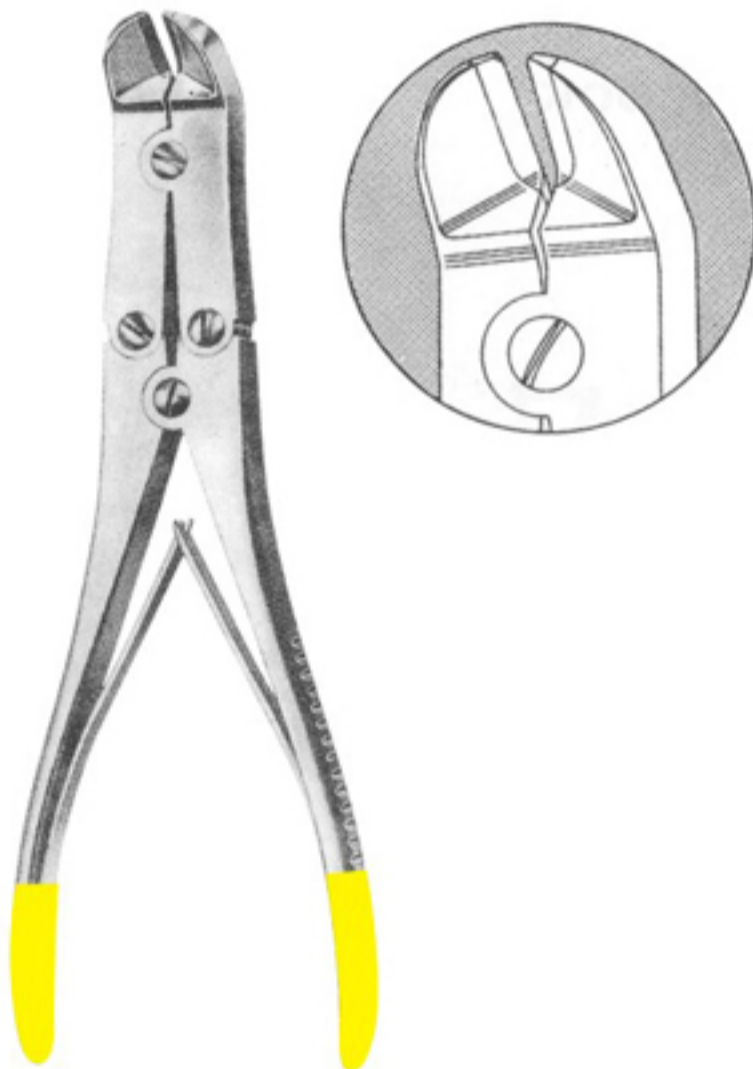

26-182
MULLAR CLAUS
22 cm



26-183
Plier
17.5 cm

Alphabetical Index

A	
ABRAHAM, tonsil knife	13
ADSON, forceps	33
ADSON, forceps	37
ALLIS, artery traction forceps	47
ALLIS, intestinal grasping forceps	86
ALY, aesthesiometer	01
AMPUTATING KNIVES	12
ANDREW, tongue depressor	04
ANESTOPHON, stethoscope	02
ARRUGA, forceps	37
ARRUGA, needle holder	61
ASCH, biopsy curettes	112
AUFRIEHT, rasps	138
AYRE, cone knife, 235mm	13
ADSON - BROWN, Tissue Forceps	39
ADSON, Haemostatic Forceps	52
ANGLE, Wire Cutters Cutting Scissors	151
B	
BABCOCK, intestinal grasping forceps	86
BABY-ALLIS, artery traction forceps	47
BACKHAUS, towel clamps	48
BACKHAUS-KOCHER, towel clamps	48
BAILEY, rib spreaders	128
BAKES, gall duct dilators	95
BALFOUR, abdominal retractors	85
BALFOUR-BABY, abdominal retractors	84
BANE-HARTMANN, bone rongeurs	144
BARTH, bone curettes	139
BABY-MOSQUITO, Haemostatic Forceps	51
BABY-ROUX, Retractors	73
BABY-SENN-MILLER, Retractors	73
BEEBE wire scissor	29
BEER, cilia forceps	42
BENGOLEA, delicate forceps	50
BERGER, biopsy forceps	115
BERLINER, percussion hammer	01
BENDING PLIERS, Wire Holding forceps	150
BERTILLON, Examination & Measuring Instruments	10
BIEMER, vein scissor	16
BISHOP-HARMON, forceps	37
BIEMER, Suction Instruments	158
BLAKE, gall stone forceps	96
BLUMENTHAL, bone rongeurs	144
BONNEY, tissue forceps	41
BOSE, tracheal hooks	119
BOWLES, stethoscope	02
BOYS-ALLIS, artery traction forceps	47
BOZEMANN, dressing forceps	108
BOYNTON, Needle Holders	47
BRAUN, artery traction forceps	107
BRAUN, uterine probes	28
BRAUN-STADLER episiotomy scissor	31
BRAUN-STADLER, bandage scissors	102
BRIESKY, vaginal specula	66
BRODIE, probes	34
BROPHY, dissecting forceps	04
BRUENINGS, tongue depressor	13
BRUNINGS, tonsil knife, 215mm	76
BRUNNER, retractors	126
BRUNNER, rib shears	31
BRUNS, plaster scissor	64
BRYANT, sponge forceps	43
BROPHY, Tissue Forceps	38
BROWN, Tissue Forceps	39
BUCHS, retractors	75
BUCHWALD, tongue depressor	04
BUCK, neurological hammer	01
BUMM, ovum forceps	230
BUCK, Ear Curettes	110
C	
CASPAR, retractor	75
CASPAR, Micro scissor 115mm	16
CASTROVIEJO, tissue forceps	37
CASTROVIEJO, micro spring scissor	15
CASTROVIEJO, needle holder	61
CASTROVIEJO, eye scissor 110mm	15
CASTROVIEJO, eye scissor 115mm	15
CATLIN, amputating knife 160mm	12
CALIPER, Examination & Measuring Instruments	10
CARREL, Haemostatic Forceps	51
CARROLL, Examination & Measuring Instruments	10
CASPAR, Rongeurs	133
CASPAR, Rongeurs	134
CASTROVIEJO, Examination & Measuring Instruments	10
CHAPUT, artery traction forceps	47
CLOWARD, lamina Spreaders	83
CLAUS PLIER, Wire Cutting Plier With T.C. Inserts	187
CLAUS PLIER, Wire Cutting Plier With T.C. Inserts	187
COAKLEY, antrum trocars	100
COLLIN, intestinal grasping forceps	86
COLLIN, rib shears	126
COLLIN, sponge and dressing forceps	44
COLLIN, tongue forceps	05
COLLIN, vaginal spatula	101
CONE KNIFE 235mm11	13
CONVERSE, fine wound retractor	69
COOLEY, multi purpose clamps	122
COTTLE, retractors	71
COTTLE, nasal scissor	25
COTTLE, fine wound retractor	69
COTTLE, mallets	140
COLLIN, Examination & Measuring Instruments	10
COLLIN, Intestinal Grasping Forceps	46
COLLIN, Retractors	73
COLLIN-HARTMANN, Retractors	73
COTTLE, Forceps, Bayonet – Shaped	40
COTTLE, Nasal Specula	91
CRILE, Haemostatic Forceps	52
CRILE, Haemostatic Forceps	52
CRILE, Retractors	73
CUTTING PLIER, Wire Cutting Plier With T.C. Inserts	187
CRAFOORD, haemostatic forceps	50
CRILE, needle holder	63
CUSCO, vaginal specula	101
CUSHING, wound and vein retractor	71
CUSHING, dissecting forceps	34
CUSHING-KOCHER, retractors	71
CZERNY, gall stone forceps	96
CZERNY, retractors	72

Alphabetical Index

D		F	
DAVIDSON, scapula retractors	77	FARABEUF, Retractors	73
DAVIS, vascular spatulas	120	FEILCHENELD, splinter forceps	42
DANDY, Haemostatic Forceps	51	FERGUSSON, haemorrhoidal forceps	93
DE BAKEY, forceps	36	FERGUSSON, suction instrument	163
DE BAKEY, anastomosis clamps	89	FERGUSSON-ACKLAND, mouth gag	05
DE BAKEY, anastomosis clamps	125	FINOCHIETTO, forceps	58
DE BAKEY, arteriotomy scissor	22	FINOCHIETTO, rib spreader	127
DE BAKEY, vana cava clamps	123	FINSEN, tracheal hooks	119
DE BAKEY, multi purpose clamps	122	FIBER OPTIC, laryngoscopes	09
DE BAKEY, retractors	82	FINGER NAIL DRIL, Finger Nail Instruments	155
DE BAKEY, atraumata	121	FINGER RING SAW, Finger Nail Instruments	155
DEAN, nasal and tonsil scissor	25	FINSTERER, Suction Instruments	161
DEAVER, retractors	77	FLAT-NOSED PLIERS, Wire Holding forceps	150
DEAVER, surgical scissor (flat lock)	21	FOERSTER-BALLENGER, Tissue Grasping Forceps	45
DE-BAKEY, bulldog clamps	49	FORCEPS, Finger Nail Instruments	155
DEJERINE, percussion hammer	01	FOREGGER, laryngoscopes	09
DELICATE DISSECTING FORCEPS	33	FOMON, nasal scissor	19
DELICATE SCISSORS, blunt points	19	FORD-BOWLES, stethoscope	02
DELICATE SCISSORS, sharp points	18	FOWLER, tonsil knife	13
DELICATE SCISSORS, sharp points	19	FRANCKE, blood lancet	06
DENHARDT, mouth gag	05	FRAZIER, fine wound retractor	69
DENIS-BROWENE, intestinal forceps	41	FRAZIER, suction instruments	163
DERRA, multi purpose clamps	122	FREER, fine wound retractor	69
DESCHAMPS, ligature needles	65	FREER, vascular spatulas	120
DESJARDINS, gall duct forceps	95	FRENZEL, tongue depressor	04
DESJARDINS, gall stone forceps	96	FRICKE, haemostatic forceps	56
DESJARDINS, gall stone scoops	95	FRITSCH, retractor	79
DESMARRES, wound and vein retractors	71		
DEMEL, Cerclage Instruments	148	G	
DIAGNOSTIC SETS	07	GALLAHER, rasp	126
DICK, vaginal clamps and compression forceps	59	GELPI, special retractors	82
DIEFFEBACH, bulldog clamps	49	GELPI, vaginal retractors	105
DINGMANN, bone holding forceps	142	GERALD, dissecting forceps	34
DISSECTING KNIVES	11	GIERTZ-STILLE, rib shears	126
Dissection Instruments	164	GILL, tissue forceps	37
Dissection Instruments	165	GILL-HESS, tissue forceps	37
Dissection Instruments	166	GILLIES, fine wound retractor	69
DITTEL, metal bougies	80	GILLIES, needle holder	63
DOYEN, abdominal retractors	79	GLOVER, bulldog clamp	49
DOYEN, intestinal clamps	87	GLUCK, rib shears	126
DOYEN, ovum forceps	230	GOOD, tonsil scissors	25
DOYEN, probes	66	GORNEY, suction instruments	163
DOYEN, towel clamps	48	GOSSET, abdominal retractors	84
DOYEN, vaginal specula	104	GRAEFE, fine wound retractor	69
DUROGRIP, Wire Holding forceps	149	GRAVE, vaginal specula	102
DUROTIP, Cutting Pliers	152	GROSS, dressing forceps	43
DUROTIP, Cutting Pliers	153	GUEDEL-NEGUS, laryngoscope	08
DUROTIP, Wire Cutters Cutting Scissors	151	GUTHRIE, fine wound retractor	69
DUVAL-COLLIN, Intestinal Grasping Forceps	46	GUYON, kidney clamps	97
DUPLAY, sponge and dressing forceps	43	GERALD, Tissue Forceps	38
DUVAL, intestinal forceps	41	GILLIES, Tissue Forceps	38
		GOLDSMITH, Nasal Specula	91
E		GRAEFE, Tissue Forceps	39
EISELSBERD, needle holder	63	GRAEFE, Tissue Forceps	39
ELSCHING, forceps	37	GRUENWALD, Forceps, Bayonet – Shaped	40
ENGL.MOD, towel clamps	48		
EPPENDORF, biopsy forceps	115	H	
ESMARCH, cloth and plaster scissors	31	HALLE, vascular spatulas	120
EISELSBERG-MATHIEU, Needle Holders	64	HALSTED-MOSQUITO, haemostatic forceps	50
EXTRACTION PLIERS, Wire Holding forceps	150	HARTMANN, intestinal clamps	87

Alphabetical Index

HARVEY, plate scissors	29	KELLY, tissue grasping forceps	44
HAJEK-KOFLER, Punches	130	KERN-LANE, bone holding forceps	143
HALSTED, Haemostatic Forceps	52	KERRISON-JACOBY, punches	129
HALSTED-MOSQUITO, Haemostatic Forceps	51	KERSTING, anastomosis forceps	89
HARTMANN, Ear Polypus Forceps	112	KELLY, Haemostatic Forceps	51
HARTMANN-HALLE, Nasal Specula	91	KERRISON, Punches	130
HARTMANN-HERZFELR, Ear Polypus Forceps	112	KILLIAN, bone shear	26
HARTMANN-HOFFMAR, Ear Polypus Forceps	112	KILLIAN, rectal spatula	90
HARTMANN-WULLSTEIN, Ear Polypus Forceps	112	KILNER, fine dissecting scissors	22
HARVEY, Wire Cutters Cutting Scissors	151	KILNER, fine wound retractor	69
HEANEY, needle holder	62	KILNER, dissecting scissor	22
HEGAR, needle holder	62	KILLIAN, Nasal Specula	90
HEGAR-OLSEN, needle holder	63	KIRSCHNER, Cutting Pliers	154
HEGER, uterine dilators	106	KIRSCHNER, Wire Extension	147
HEISS, haemostatic forceps	50	KOCHER, Haemostatic Forceps	52
HEISS, dressing forceps	58	KOCHER, Haemostatic Forceps	54
HEISTER, mouth gag	05	KOCHER-OCHSNER, Haemostatic Forceps	55
HENING, plaster spreader	157	KLIMA ROSEGGER, trocars	100
HERGET, biopsy forceps	113	KOCHER, retractor	71
HERTZLER, abdominal retractors	84	KOCHER, bladder retractors	99
HERTZLER, rib spreaders	127	KOCHER, bone retractor	74
HESS, tissue forceps	37	KOCHER, retractors	75
HEYMANN-KNIGHT, scissors	25	KOLLE, blood lancet	06
HEYWOOD-SMITH, ovum forceps	109	KONIG, elevators	135
HEYWOOD-SMITH, sponge holding forceps	44	KONIG, raspatories	137
HEYWOOD-SMITH, tongue forceps	05	KONISATION SMESSER, retractors	57
HOLLOW NEEDLE, Suction Instruments	159	KRAUSE, biopsy tip	115
HOUSE, Suction Instruments	161	KRISTELLER, vaginal specula	102
HUBER, biopsy forceps	115	KRISTELLER, vaginal specula	103
HUNT, tumor & vessel forceps	32	KRONECKER, suture instruments	65
HUNTER, splinter forceps	42	KRONLEIN, haemostatic forceps	56
		KUMMEL, intestinal spatula	80
I		L	
INGE, lamina spreaders	83	LABORDE, tracheal dilators	119
INTEROSSEOUS, cartilage knife	12	LAHEY, artery traction forceps	47
IVES-FANSLER, anosscopes	92	LAHEY, gall duct forceps	94
J		LANE TRETOWAN, bone levers	136
JACKSON BURROWS, retractors	82	LANE, bone holding forceps	143
JACOBSON, bone curettes	139	LANE, bone levers	136
JACOBSON, needle holder	61	LANE, tissue forceps	41
JAEGAR, fine wound retractor	69	LANE, towel clamps	48
JAMESON, dissecting scissor	22	LANGE-HOHMANN, bone levers	136
JAMESON, needle holder	62	LANGENBACK, bone levers	135
JANSEN, bone curettes	139	LANGENBECK, with triangle handle	70
JANSEN, bone rongeurs	144	LANGENBECK, flap knife	12
JOHNS-HOPKING, bulldog clamps	49	LARYNGEAL MIRRORS	06
JOLL (FRIEDMAN), retractors	82	LAWRENCE, ligature forceps	58
JOLL, vaginal retractors	105	LANDOLT, Suction Instruments	160
JONES, towel clamps	48	LANDOLT, Suction Instruments	161
JOSEPH, bone file	138	LANGENBECK, Ear Curettes	110
JOSEPH, dura and skin retractor	69	LEBSCHKE, rib shears	126
JOSEPH, raspatories	137	LEGUEU, bladder retractors	99
JUDD-MASSON, bladder retractors	99	LEKSELL-STILLE, bone rongeurs	145
JANSEN, FORCEPS, Bayonet – Shaped	40	LERICHE, intestinal spatula	80
K		LEWIS, bone file	138
KADER, intestinal spatula	80	LISTER, bandage scissor	30
KALT, needle holder	61	LISTER, cloth scissor	30
KELLY, ovum forceps	109	LISTER, sponge forceps	43
KELLY, anosscopes	92	LISTON, bone cutting forceps	146

Alphabetical Index

LOCKHART-MUMMERY, probes	66	MULLER, dura and skin retractor	69
LOCKWOOD, Intestinal Grasping Forceps	46	MURPHY, head band	03
LUCAE, FORCEPS, Bayonet – Shaped	40	MUSEUX, tissue grasping forceps	47
LUER, Retractors	73		
LOCKLIN, delicate scissor	25	N	
LOPEZ-REINKE, suction instruments	163	NASAL SCISSORS	25
LOWER, gall duct forceps	94	NAUJOKS wire scissors	29
LOWMAN, bone clamps	143	NAIL SPLITTING, Finger Nail Instruments	155
LOWMAN-GERSTER, bone clamps	143	NEEDLE HOLDER, for micro surgery	48
LOWMAN-HOGLUND, bone clamps	143	NEGUS, tonsil forceps	57
LUCAS, gouges	141	NELATON, probes	66
LUER-KORTE, gall stone scoops	80	NELSON, lung dissecting forceps	41
LURE, bone rongeurs	144	NISSEN, gall duct forceps	94
		NOTO, ovum forceps	109
M		NOTO, sponge holding forceps	44
MAGILL, laryngoscope	07	NOVAK-SCHOECKAERT, biopsy curettes	111
MALTZ, rasps	138	NOYES, micro spring scissor	15
MANNERFELT, osteotomes	141		
MANNERFELT, retractors	70	O	
MARTIN, uterine probes	107	OLIVECRONA, dura scissors	24
MARTINI, bone curettes	139	OLIVECRONA, trigeminal knife	13
MASING, retractors	71	OTOSCOPE SETS	07
MASSON, needle holder	62	OTOSCOPE, Diagnostic Sets	07
MASSON-LUETHY, needle holder	62		
MATHIEU, retractors	72	P	
MAYO, dissecting scissors	23	PARTSCH, raspatories	137
MAYO, uterine probes	107	PARTSCH, gouges	141
MAYO-HARRINGTON, dissecting scissors	23	PARTSCH, raspatories	137
MAYO-NOBLE, dissecting scissors	23	PAYR, pylorus clamps	86
MAYO-STILLE, dissecting scissors	23	PEAN, haemostatic forceps	57
MARTIN, Nasal Specula	90	PEAN, haemostatic forceps	51
MATHIEU, Needle Holders	64	PEAN, kidney clamps	97
MATHIEU-STILLE, Needle Holders	64	PEDERSON, vaginal specula	102
MC INDOE, forceps	34	PEET, splinter forceps	42
MC KENTY, raspatories	137	PELKMANN, uterine dressing forceps	108
MEAD, mallets	140	PERKINS, self retaining retractors	81
MC INDOE, Tissue Forceps	38	PIERCE, trocars	100
MCINTOSH, laryngoscopes	09	PINARD, wooden stethoscope	02
MEDIUM, Dissecting Forceps	35	PLESTER, retractors	81
MICRO-HALSTED, Haemostatic Forceps	51	PLESTER, suction instruments	163
MILLIN, Needle Holders	64	POOL, suction instruments	162
MICHEL, laryngeal mirrors	06	POTTS-SMITH, cardiovascular scissor	24
MICRO SCISSORS, laterally angled	17	PROBES	67
MICRO-ADSON, forceps	33	PARKER, Retractors	73
MICRO-ADSON, forceps	37	PEAN, Haemostatic Forceps	52
MIDDELDORPF, retractors	75	PEAN, Haemostatic Forceps	53
MIKULICZ, tissue forceps	57	PEAN, Haemostatic Forceps	54
MIKULICZ, intestinal spatula	80	PENNINGTON, Tissue Grasping Forceps	45
MIKULICZ, retractors	78	PROVIDENCE-HOSPITAL, Haemostatic Forceps	51
MILLER, laryngoscope	08		
MILLIN, bladder retractors	99	Q	
MIXTER, ligature forceps	58	QUERVAIN, bone levers	113
MOD.USA, plaster spreader	127		
MORRIS, anastomosis clamps	89	R	
MOYNIHAN, haemostatic forceps	57	RABINER, neurological hammer	01
MOYO-HEGAR, needle holder	62	RANDALL, biopsy curettes	111
MOD. WIEN, Nasal Specula	91	RANDALL, kidney stone forceps	98
MOLTGEN, Examination & Measuring Instruments	10	RECAMIER, uterine scoops	116
MULLAR, Wire Cutting Plier With T.C. Inserts	187	REYNOLDS, dissecting scissors	22
MULLER LIGATURE FORCEPS	49	RICHTER, vaginal retractors	105
MULLER VESSEL CLIPS	49	ROCHESTER-CARMALT, haemostatic forceps	57
		ROEDER, towel clamps	48

Alphabetical Index

ROUX, retractors	72
RUDD, haemorrhoidal ligator	93
RUMEL, dissecting forceps	58
RUSS-MODELL, tissue forceps	41
ROHRSCHEIDER, needle holder	61
ROLLET, dura and skin retractor	69
ROSER KONIG, mouth gag	05
RAMPLEY, Tissue Grasping Forceps	45
RANKIN, Haemostatic Forceps	52
REILL, Cutting Pliers	152
REPLACEMENT LAMP, laryngoscopes	09
ROCHESTER-OCHSNER, Haemostatic Forceps	54
ROCHESTER-PEAN, Haemostatic Forceps	53
ROSE, Retractors	73
ROUND PLIERS, Wire Holding forceps	150

S

SAENGER, ovum forceps	118
SAMII, tumor grasping forceps	32
SATINSKY, vena cava scissors	24
SAUPE, cilia forceps	42
SCALPEL HANDLES	14
SCHAAF, cilia forceps	42
SCHAEDEL, towel clamps	48
SCHEINMANN, biopsy forceps	115
SCHIMMELBUSCH, ether mask	05
SCHMID, vascular spatulas	120
SCHOEMAKER-LOTH, needle holder	63
SCHOENBORN, retractors	71
SCHRODER, uterine scoops	116
SCHUMACHER, rib shears	126
SCHUMACHER, umbilical scissors	28
SCHUMASHER, biopsy forceps	114
SCOVILLE-RICHTER, retractors	67
SEGOND, myomatome	13
SEIDL, vaginal specula	102
SEIDL-DBP, biopsy forceps	114
SELLORS, rib spreaders	128
SEMKEN, dissecting forceps	34
SEMKEN, tissue forceps	37
SENN-MILLER, Retractors	73
SEUTIN, plaster scissor	31
SHAPLEIGH, Ear Curettes	110
SIMON, uterine scoops	116
SIMPLEX, tongue depressor	04
SIMPSON, uterine probes	107
SIMPSON-BRAUN, obstetrics forceps	117
SIMS, gynaecology scissors	27
SIMS, vaginal specula	102
SIMS, rectal specula	90
SIMS, uterine probes	107
SMOOTH JAWS FORCEPS	34
ST.MARTIN, tissue forceps	37
STEMBERG, tongue depressor	04
STIEGLITZ, splinter forceps	42
STILLE, bone rongeurs	145
STILLE-AESULAP, plaster shears	156
STILLE-RUSKIN, bone rongeurs	145
STRACK, wire scissor	29
STRASSBURGER Tissue forceps	41
STANDARD, Dissecting Forceps	35
STANDARD, Tissue Forceps	39

STERBERG, Retractors	
STRULLY, cardiovascular scissors (pointed)	24
SUCTION INSTRUMENTS	162
SURGICAL SCISSORS, incision	21
SURGICAL SCISSORS, serrated	20
SURGICAL SCISSORS, slender type	20
SURGICAL SCISSORS, standard	20
SURGICAL SCISSORS, standard	20
SUTURING INSTRUMENT SET	68
SYSTRUNK, nail splitting scissors	21
SPENCER-WELLS, Haemostatic Forceps	
SYSTRUNK, Finger Nail Instruments	

T

TAKAHASHI, rongeur	112
TAYLOR, percussion hammer	01
TAKAHASHI, Rongeurs	132
THOREK, cardiovascular scissors	24
THORPE, corneal forceps	33
TIECK-HALLE, Nasal Specula	90
TOENNIS, Wire Cutting Plier With T.C. Inserts	187
TOWNLEY, Examination & Measuring Instruments	10
TOBOLD, tongue depressors	04
TOENNIS ADSON, dissecting scissors	22
TOENNIS, dissecting scissors	22
TOENNIS, fine wound retractor	69
TOENNIS, vascular spatulas	120
TOENNIS, needle holder	63
TRELAT, raspatories	137
TRIGEMINAL KNIFE	13
TROCARS	100
TROEMNER, percussion hammer	01
TROUSSEAU, tracheal dilators	119
TROCAR, Suction Instruments	159
TROELTSCH, FORCEPS, Bayonet – Shaped	40
TUFFIER, rib spreaders	127
TUTTLE, lung dissecting forceps	41

U

UMBILICAL CORD SCISSORS	28
UNIVERSAL BANDAGE SCISSORS	30
UNIVERSAL TROCARS	100
US-ARMY, retractors	72

V

VANNAS, micro spring scissors	15
VERNIER, Examination & Measuring Instruments	10
WISE GRIP, Wire Holding forceps	150
VOLKMANN, bone curettes	139
VOLKMANN, bone retractors	74

Alphabetical Index

W

WANGENSTEEN, needle holder	62
WARTENMERG, pinwheel	01
WAGNER, Rongeurs	134
WAUGH, Tissue Forceps	38
WEBER, anastomosis clamps	124
WECKER, eye scissors	15
WEIL-BLAKESLEY, rongeurs	112
WEITLANER, self retaining retractors	81
WERTHEIM, gynaecology scissors	27
WERTHEIM, clamps and forceps	59
WERTHEIM-CULLEN, vaginal clamps	60
WIEDER, tongue depressor	04
WEIL-BLAKESLEY, Rongeurs	132
WILLIGER, bone curettes	139
WILLIGER, elevators	135
WILLIGER, raspatories	137
WINTER, ovum forceps	118
WILDE, Forceps, Bayonet – Shaped	40
WOLFF, plaster breakers	157
WULLSTEIN, retractors	81
WULLSTEIN, Suction Instruments	160

Y

YASARGIL, needle holder	61
YASARGIL, tumor grasping forceps	32
YASARGIL-SAMII, tumor grasping forceps	32
YASARGIL, Suction Instruments	160
YASARGIL, Suction Instruments	161
YASRGIL, micro scissors	17
YEOMAN, biopsy forceps	113
YOUNG, tongue forceps	05
YOUNG– HRYNTSCHAK, Needle Holders	64
YOUNG-MILLIN, Needle Holders	64

Z

ZENKER, ligature	58
ZENKER, retractors	77
ZIEGLER, head band	03
ZIEGLER, head mirror	03



Manufacturer & Supplier of Health Care Instruments

New Miana Pura East, Roras Road, Sialkot 51310 - Pakistan.

Tel: +92-52-3253481 | Fax: +92-52-3253482 | WhatsApp: +92-344-6356075

info@hillmetalinstruments.com / hillmetalinstruments@gmail.com / www.hillmetalinstruments.com

